

Технические характеристики

По вопросам продаж и поддержки обращайтесь:

Алматы (7273)495-231	Казань (843)206-01-48	Новокузнецк (3843)20-46-81	Смоленск (4812)29-41-54
Архангельск (8182)63-90-72	Калининград (4012)72-03-81	Новосибирск (383)227-86-73	Сочи (862)225-72-31
Астрахань (8512)99-46-04	Калуга (4842)92-23-67	Омск (3812)21-46-40	Ставрополь (8652)20-65-13
Барнаул (3852)73-04-60	Кемерово (3842)65-04-62	Орел (4862)44-53-42	Сургут (3462)77-98-35
Белгород (4722)40-23-64	Киров (8332)68-02-04	Оренбург (3532)37-68-04	Тверь (4822)63-31-35
Брянск (4832)59-03-52	Краснодар (861)203-40-90	Пенза (8412)22-31-16	Томск (3822)98-41-53
Владивосток (423)249-28-31	Красноярск (391)204-63-61	Пермь (342)205-81-47	Тула (4872)74-02-29
Волгоград (844)278-03-48	Курск (4712)77-13-04	Ростов-на-Дону (863)308-18-15	Тюмень (3452)66-21-18
Вологда (8172)26-41-59	Липецк (4742)52-20-81	Рязань (4912)46-61-64	Ульяновск (8422)24-23-59
Воронеж (473)204-51-73	Магнитогорск (3519)55-03-13	Самара (846)206-03-16	Уфа (347)229-48-12
Екатеринбург (343)384-55-89	Москва (495)268-04-70	Санкт-Петербург (812)309-46-40	Хабаровск (4212)92-98-04
Иваново (4932)77-34-06	Мурманск (8152)59-64-93	Саратов (845)249-38-78	Челябинск (351)202-03-61
Ижевск (3412)26-03-58	Набережные Челны (8552)20-53-41	Севастополь (8692)22-31-93	Череповец (8202)49-02-64
Иркутск (395)279-98-46	Нижний Новгород (831)429-08-12	Симферополь (3652)67-13-56	Ярославль (4852)69-52-93
Россия (495)268-04-70	Киргизия (996)312-96-26-47	Казахстан (7172)727-132	

Urologie-Instrumente – Genito-Urinary Instruments

Nierenklemmen

Kidney Clamps

EF



AIRAUMATA®



EF001R
240 mm
9 1/2"

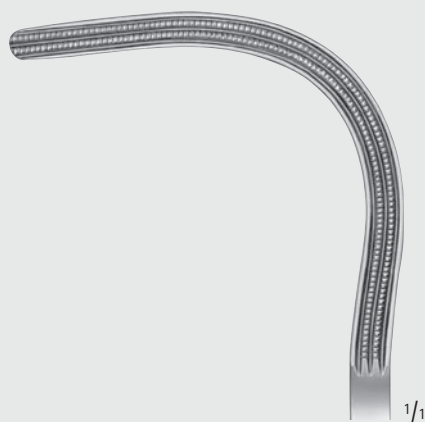

EF003R
230 mm
9"

GUYON

EF001R-EF003R



EF002R
230 mm
9"

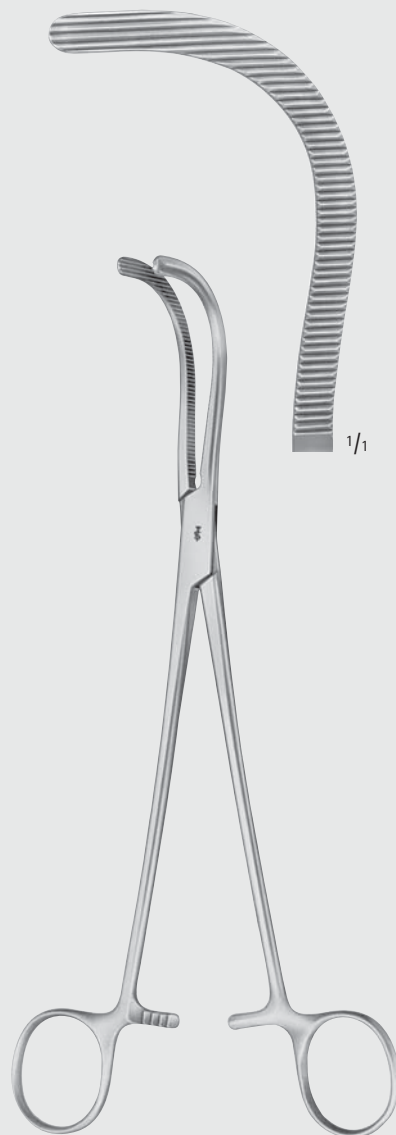

GUYON

EF011R

230 mm, 9"



Urologie-Instrumente – Genito-Urinary Instruments

Nierenklemmen

Kidney Clamps

EF

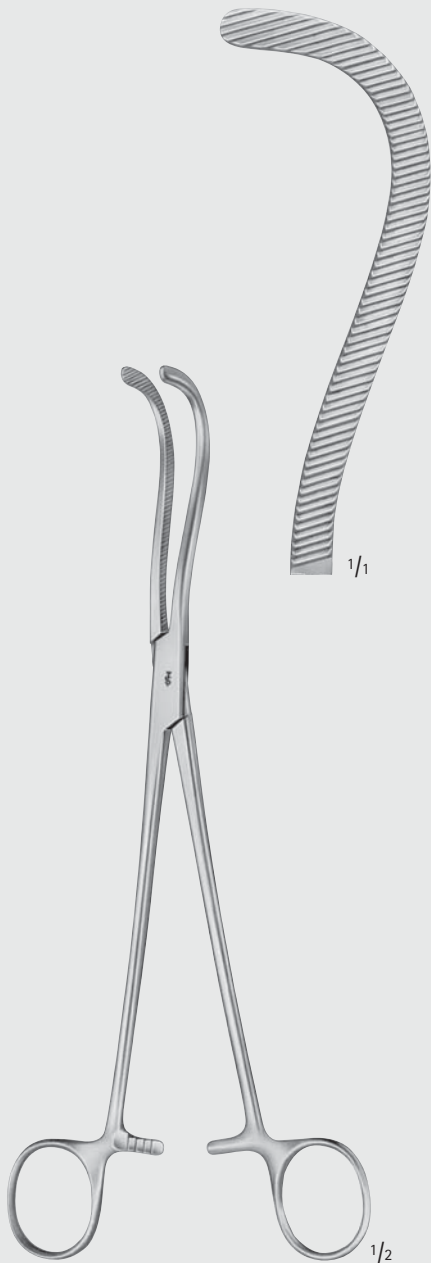

GUYON

EF010R

235 mm, 9 1/4"

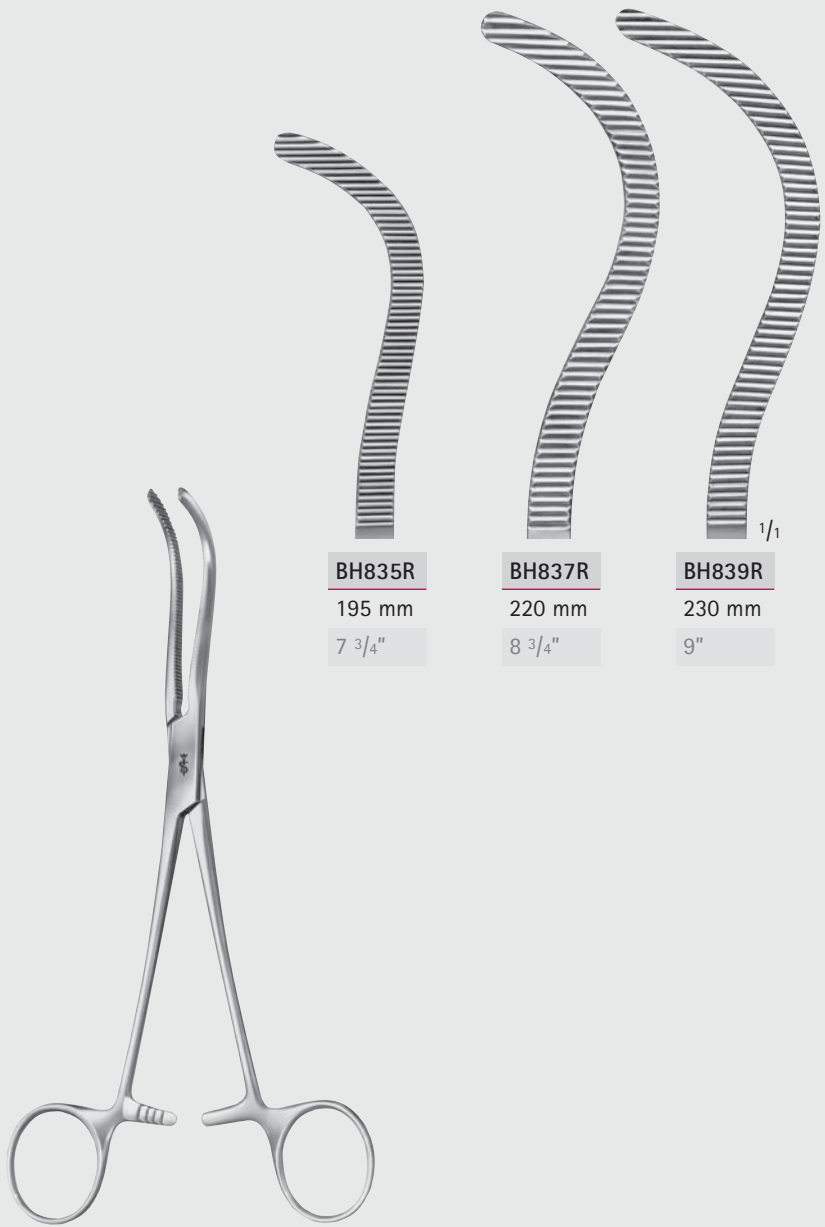

PEAN

BH835R-BH839R

BH835R

195 mm

7 3/4"

BH837R

220 mm

8 3/4"

BH839R

230 mm

9"



MILLIMETERS

Urologie-Instrumente – Genito-Urinary Instruments

Nierenklemmen

Kidney Clamps

EF

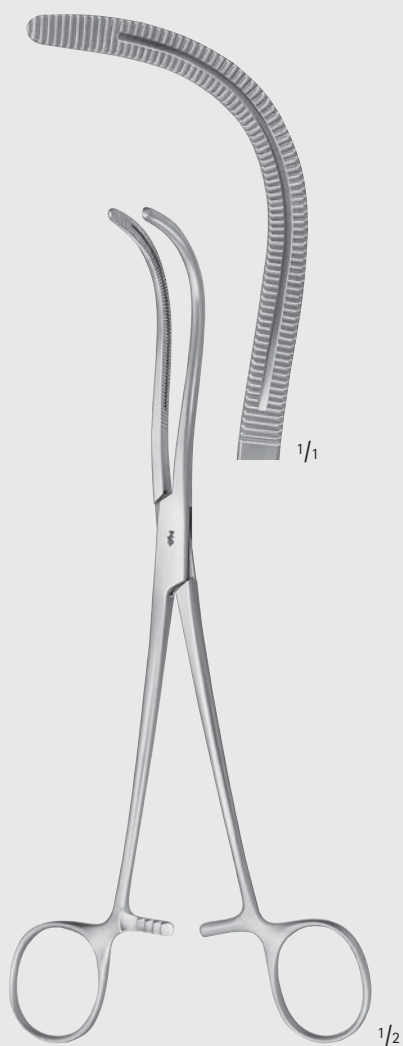

STILLE

EF016R

220 mm, 8 3/4"

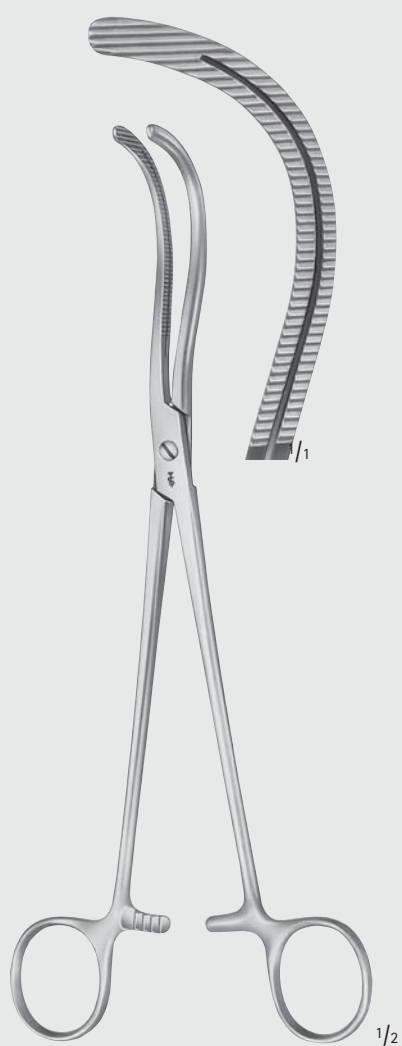

STILLE

EF015R

240 mm, 9 1/2"

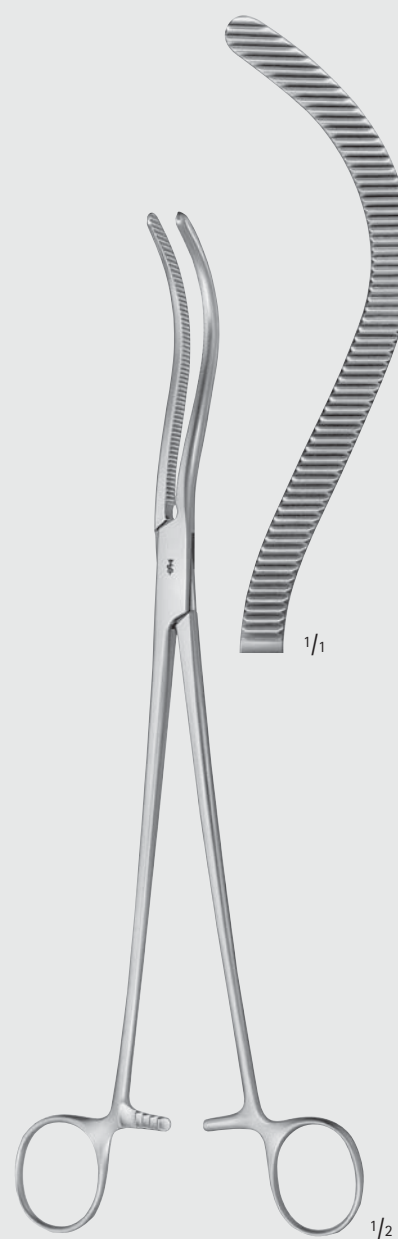

GUYON

EF012R

265 mm, 10 1/2"



Urologie-Instrumente – Genito-Urinary Instruments

Nierenstielklemmen
Kidney Pedicle Clamps

EF

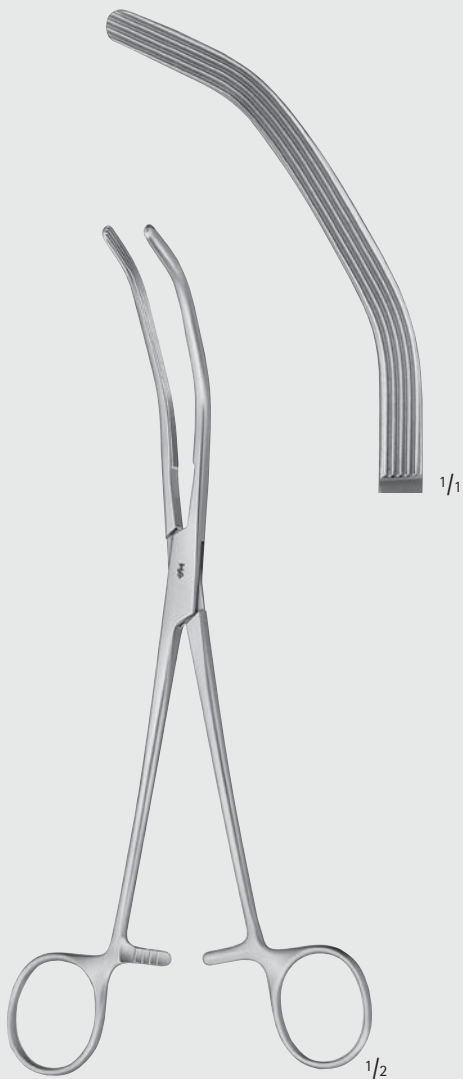

HERRICK

EF030R

225 mm, 9"



WERTHEIM

BJ574R

255 mm, 10"



MILLIMETERS

Urologie-Instrumente – Genito-Urinary Instruments

Nierenstielklemmen

Kidney Pedicle Clamps

EF



1/1



1/2

WERTHEIM-CULLEN

BJ579R

Winkel- und Druckklemme
Angle- and pressure clamp

215 mm, 8 1/2"

AIRAUMATA®



90°

67 mm



1/2

WERTHEIM

BJ581R

Winkel- und Druckklemme
Angle- and pressure clamp

250 mm, 10"



Urologie-Instrumente – Genito-Urinary Instruments
Nierenfasszangen
Kidney Elevating Forceps

EF



COLLIN

EO405R

285 mm, 11 1/4"



DARTIGUES

EO407R

255 mm, 10"

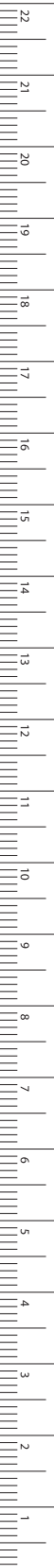

MILLIMETERS

Urologie-Instrumente – Genito-Urinary Instruments

Nierensteinzangen

Kidney Stone Forceps

EF



EF047R

170 mm

6 ³/₄"

EF048R

160 mm

6 ¹/₄"



HEIMING

EF047R-EF048R

für Kinder
for children



EF051R

EF052R

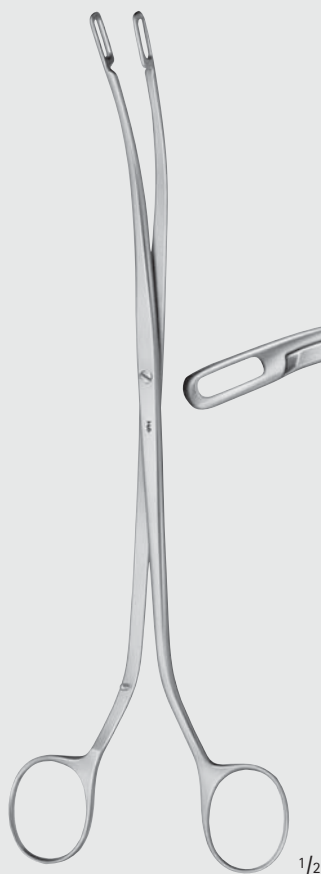

RANDALL

EF051R-EF054R

225 mm, 9"

EF053R

EF054R



Urologie-Instrumente – Genito-Urinary Instruments
Nierensteinzangen
Kidney Stone Forceps

EF



EF055R



EF056R



1/2

RANDALL

EF055R-EF056R

190 mm, 7 1/2"

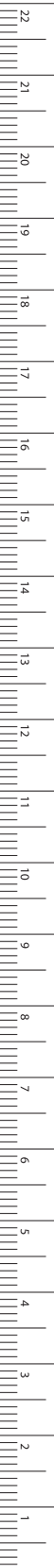

MILLIMETERS

Urologie-Instrumente – Genito-Urinary Instruments

Nierensteinzangen

Kidney Stone Forceps

EF



EB244R

245 mm

9 3/4"



EB246R

230 mm

9"

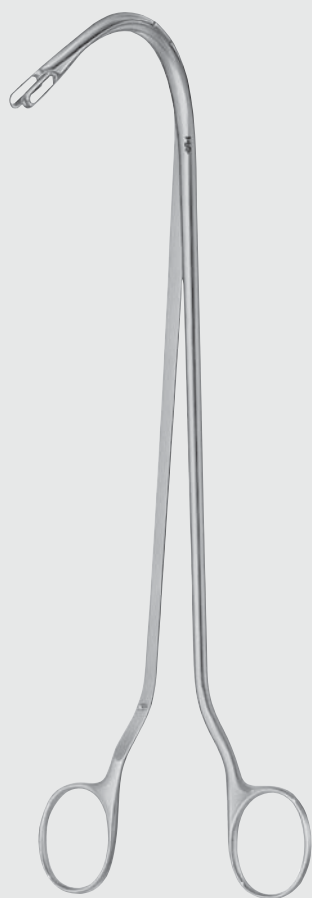

RANDALL

EB244R-EB246R

besonders schmale Modelle

extremely delicate patterns



Urologie-Instrumente – Genito-Urinary Instruments

Blasenwundspreizer

Bladder Retractors



KUGELSCHNELLVERSCHLUSS

BALL SNAP CLOSURE



BV576R



BV577R

MILLIN

BV580R

Blasenwundspreizer komplett,
bestehend aus:

- BV575R Sperrer allein
- BV576R Blätter 57 x 25 mm
- BV577R Blätter 82 x 25 mm
- BV578R Mittelblatt 105 x 45 mm

Bladder retractor complete,
consisting of:

- BV575R Spreader only
- BV576R Blades 57 x 25 mm
- BV577R Blades 82 x 25 mm
- BV578R Center blade 105 x 45 mm

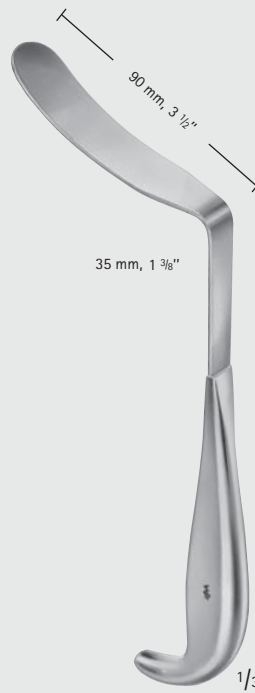

1/3

LEGUEU

BV928R

Blasenspatel

Bladder spatula

260 mm, 10 1/4"

EF

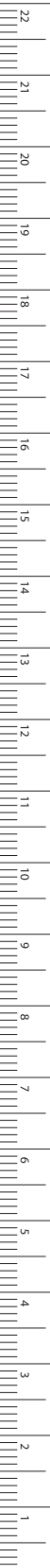

MILLIMETERS

Urologie-Instrumente – Genito-Urinary Instruments

Urologie – Prostatektomie

Genito-Urinary Instruments – Prostatectomy

EF



BB176R
12°

BB178R
25°

BARRÉ

BB176R-BB178R

No. 3 XL
für linke Hand
for left hand
250 mm, 10"



BARRÉ

BB177R

No. 3 XL
für linke Hand
for left hand
250 mm, 10"



spitz/spitz
sharp/sharp

BARRÉ

BC715R

Präparierschere
Dissecting scissors
280 mm, 11"



Urologie-Instrumente – Genito-Urinary Instruments

Urologie - Prostatektomie

Genito-Urinary Instruments - Prostatectomy

EF

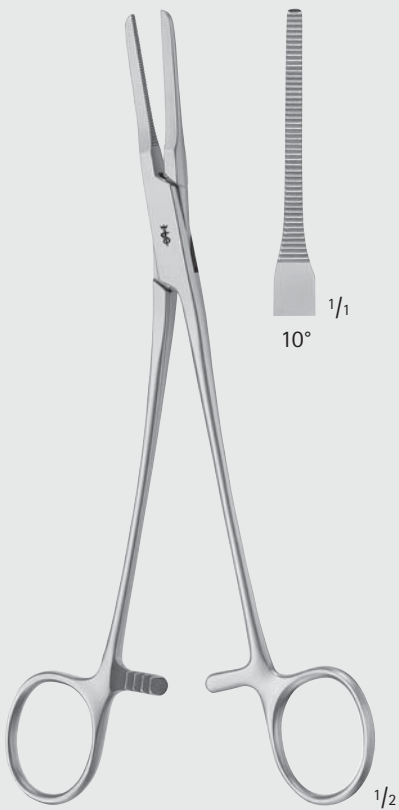

EF167R

Venenklammer

Venous plexus clamp

210 mm, 8 1/4"



BJ029R

extra fein

extra delicate

BJ110R

fein

delicate

BARRE

BJ029R-BJ110R

Präparierklemmen

Dissecting forceps

280 mm, 11"



MILLIMETERS

Urologie-Instrumente – Genito-Urinary Instruments

Urologie - Prostatektomie

Genito-Urinary Instruments - Prostatectomy

EF



BARRÉ

BT680R

Prostata-Retraktor
Prostate retractor

360 mm, 14 3/8"



BARRÉ

BT681R

Urethra-Retraktor
Urethral retractor

390 mm, 15 1/2"



BARRÉ

GK685R

Bipolare Pinzette
Bipolar forceps

260 mm, 10 1/4"

Urologie-Instrumente – Genito-Urinary Instruments

Urologie – Prostatektomie

Genito-Urinary Instruments – Prostatectomy

EF

AIRAUMATA®



MILLIN

EF163R

Kapselasszange

Lobe grasping forceps

245 mm, 9 3/4"

AIRAUMATA®



MILLIN

EF164R

Kapselasszange

Lobe grasping forceps

235 mm, 9 1/4"



MILLIN

EF168R

Fadenhalteazange

Ligature holding forceps

245 mm, 9 3/4"

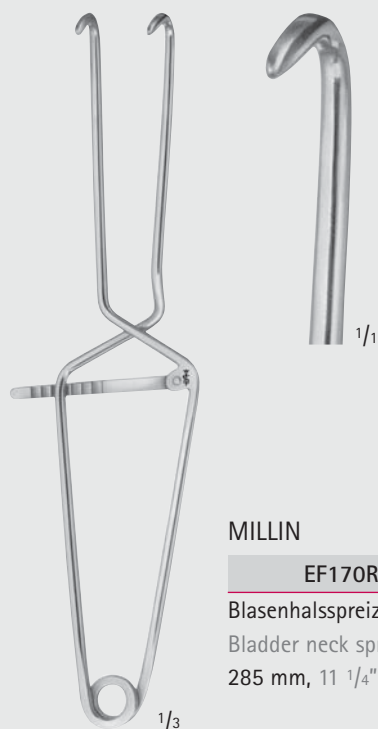

MILLIN

EF170R

Blasenhalsspreizer

Bladder neck spreader

285 mm, 11 1/4"

INCHES

Urologie-Instrumente – Genito-Urinary Instruments

Urologie-Instrumente

Genito-Urinary Instruments

EF



AIRAUMATA®



EF070R

Ureterzange

Ureter Forceps

240 mm, 9 1/2"

Urologie-Instrumente – Genito-Urinary Instruments

Urologie-Instrumente
Genito-Urinary Instruments

EF

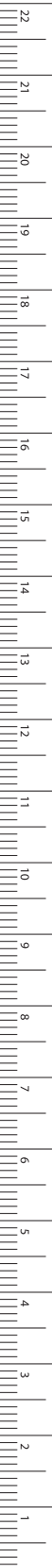

MILLIMETERS

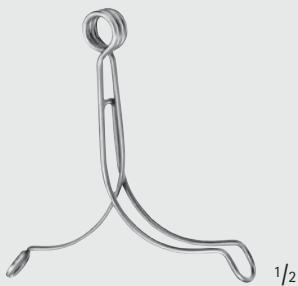

STOCKMANN

EF400R

Penisklemme

Penis clamp

70 mm, 2 3/4"



STRAUSS

EF401R

Penisklemme

Penis clamp

130 mm, 5 1/8"



EF155R

Zange zum Erfassen der
Glans und der Vorhaut,
Ring-Ø 4,8 mm

Forceps for grasping the
glans and the foreskin,
ring diam. 4.8 mm

125 mm, 5"



EF195R

Klemme zum Fixieren
des Samenstrangs

Fixation clamp for the
spermatic cord

145 mm, 5 3/4"



BT126R

Haken für den Samenstrang
Hook for the spermatic cord

165 mm, 6 1/2"



Urologie-Instrumente – Genito-Urinary Instruments

Urologie-Instrumente
Genito-Urinary Instruments

EF



1/2

Charr. (French)

EF638R	8
EF639R	9
EF640R	10
EF641R	11
EF642R	12
EF643R	13
EF644R	14
EF645R	15
EF646R	16
EF647R	17
EF648R	18
EF649R	19
EF650R	20
EF651R	21
EF652R	22
EF653R	23
EF654R	24
EF655R	25
EF656R	26
EF657R	27
EF658R	28
EF659R	29
EF660R	30

DITTEL

EF638R-EF660R

Metallbougie-Öffner, starr
Urethral bougies
and dilating sounds, stiff
345 mm, 13 3/4"



1/2

TURNER WARWICK

EF790R

Harnröhrenbougie
Retrograde bougie
180 mm, 7"



MILLIMETERS

Urologie-Instrumente – Genito-Urinary Instruments

Urologie-Instrumente

Genito-Urinary Instruments

EF



EF824R	Ben.24/Charr.12
EF826R	Ben.26/Charr.13
EF828R	Ben.28/Charr.14
EF830R	Ben.30/Charr.15
EF832R	Ben.32/Charr.16
EF834R	Ben.34/Charr.17
EF836R	Ben.36/Charr.18
EF838R	Ben.38/Charr.19
EF840R	Ben.40/Charr.20
EF842R	Ben.42/Charr.21
EF844R	Ben.44/Charr.22
EF846R	Ben.46/Charr.23
EF848R	Ben.48/Charr.24
EF850R	Ben.50/Charr.25
EF852R	Ben.52/Charr.26
EF854R	Ben.54/Charr.27
EF856R	Ben.56/Charr.28
EF858R	Ben.58/Charr.29
EF860R	Ben.60/Charr.30

GUYON

EF824R-EF860R

Metallbougie-Öffner

Urethral bougies and
dilating sounds

255 mm, 10"

Urologie-Instrumente – Genito-Urinary Instruments

Beschneidungsklemmen Circumcision Clamps

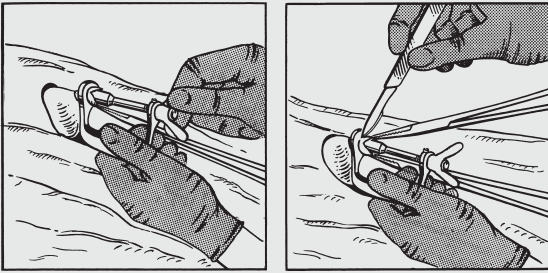

- Der glockenförmige Stempel der Beschneidungsklemme wird über die Eichel geschoben und die Vorhaut darübergezogen, was 2 Klemmen oder Haltefäden erleichtern.
- Die Flügelmutter wird so stark wie möglich angezogen, so dass die Vorhaut ringförmig maximal komprimiert wird.
- Mit dem Skalpell wird die Vorhaut unmittelbar am Kompressionsring abgetragen. Zur Vermeidung von Blutungen bleibt die Beschneidungsklemme einige Minuten liegen. Es empfiehlt sich, größere Venen, in jedem Falle aber die Frenulararterie nach etwaiger Durchtrennung zu unterbinden.
- Der Vorteil dieser Beschneidungsart liegt in der kosmetisch günstigen Narbe, wie sie nach Abstoßung des dünnen Nekrosesaumes entsteht.

- Assisted by two hemostats or ligatures the foreskin is pushed over the bellshaped protection-rod and the glans is placed into it.
- By now, the wing-nut is tightened as close as possible, so the foreskin is annular compressed. The foreskin is cut off with a scalpel, right next to the compression ring.
- The circumcision clamp remains a few minutes to avoid bleeding. In case that any large vein, specially the frenular artery, is cut through, a ligature must be set.
- The advantage of the method described is the cosmeticly favourable scar which is left after rejection of the small necrotized portion.

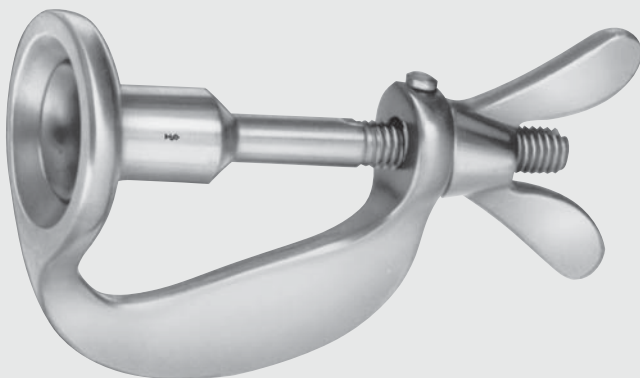

WINKELMANN

∅
diam.

EF965R 12 mm

EF966R 16 mm

EF967R 20 mm

Beschneidungsklemmen

Circumcision clamps

По вопросам продаж и поддержки обращайтесь:

Алматы (7273)495-231	Казань (843)206-01-48	Новокузнецк (3843)20-46-81	Смоленск (4812)29-41-54
Архангельск (8182)63-90-72	Калининград (4012)72-03-81	Новосибирск (383)227-86-73	Сочи (862)225-72-31
Астрахань (8512)99-46-04	Калуга (4842)92-23-67	Омск (3812)21-46-40	Ставрополь (8652)20-65-13
Барнаул (3852)73-04-60	Кемерово (3842)65-04-62	Орел (4862)44-53-42	Сургут (3462)77-98-35
Белгород (4722)40-23-64	Киров (8332)68-02-04	Оренбург (3532)37-68-04	Тверь (4822)63-31-35
Брянск (4832)59-03-52	Краснодар (861)203-40-90	Пенза (8412)22-31-16	Томск (3822)98-41-53
Владивосток (423)249-28-31	Красноярск (391)204-63-61	Пермь (342)205-81-47	Тула (4872)74-02-29
Волгоград (844)278-03-48	Курск (4712)77-13-04	Ростов-на-Дону (863)308-18-15	Тюмень (3452)66-21-18
Вологда (8172)26-41-59	Липецк (4742)52-20-81	Рязань (4912)46-61-64	Ульяновск (8422)24-23-59
Воронеж (473)204-51-73	Магнитогорск (3519)55-03-13	Самара (846)206-03-16	Уфа (347)229-48-12
Екатеринбург (343)384-55-89	Москва (495)268-04-70	Санкт-Петербург (812)309-46-40	Хабаровск (4212)92-98-04
Иваново (4932)77-34-06	Мурманск (8152)59-64-93	Саратов (845)249-38-78	Челябинск (351)202-03-61
Ижевск (3412)26-03-58	Набережные Челны (8552)20-53-41	Севастополь (8692)22-31-93	Череповец (8202)49-02-64
Иркутск (395)279-98-46	Нижний Новгород (831)429-08-12	Симферополь (3652)67-13-56	Ярославль (4852)69-52-93
Россия (495)268-04-70	Киргизия (996)312-96-26-47	Казахстан (7172)727-132	