

Технические характеристики

По вопросам продаж и поддержки обращайтесь:

Алматы (7273)495-231	Казань (843)206-01-48	Новокузнецк (3843)20-46-81	Смоленск (4812)29-41-54
Архангельск (8182)63-90-72	Калининград (4012)72-03-81	Новосибирск (383)227-86-73	Сочи (862)225-72-31
Астрахань (8512)99-46-04	Калуга (4842)92-23-67	Омск (3812)21-46-40	Ставрополь (8652)20-65-13
Барнаул (3852)73-04-60	Кемерово (3842)65-04-62	Орел (4862)44-53-42	Сургут (3462)77-98-35
Белгород (4722)40-23-64	Киров (8332)68-02-04	Оренбург (3532)37-68-04	Тверь (4822)63-31-35
Брянск (4832)59-03-52	Краснодар (861)203-40-90	Пенза (8412)22-31-16	Томск (3822)98-41-53
Владивосток (423)249-28-31	Красноярск (391)204-63-61	Пермь (342)205-81-47	Тула (4872)74-02-29
Волгоград (844)278-03-48	Курск (4712)77-13-04	Ростов-на-Дону (863)308-18-15	Тюмень (3452)66-21-18
Вологда (8172)26-41-59	Липецк (4742)52-20-81	Рязань (4912)46-61-64	Ульяновск (8422)24-23-59
Воронеж (473)204-51-73	Магнитогорск (3519)55-03-13	Самара (846)206-03-16	Уфа (347)229-48-12
Екатеринбург (343)384-55-89	Москва (495)268-04-70	Санкт-Петербург (812)309-46-40	Хабаровск (4212)92-98-04
Иваново (4932)77-34-06	Мурманск (8152)59-64-93	Саратов (845)249-38-78	Челябинск (351)202-03-61
Ижевск (3412)26-03-58	Набережные Челны (8552)20-53-41	Севастополь (8692)22-31-93	Череповец (8202)49-02-64
Иркутск (395)279-98-46	Нижний Новгород (831)429-08-12	Симферополь (3652)67-13-56	Ярославль (4852)69-52-93
Россия (495)268-04-70	Киргизия (996)312-96-26-47	Казахстан (7172)727-132	

Abdominale Chirurgie – Abdominal Surgery

Biopsiezangen für Rektum

Biopsy Forceps for Rectum

EA

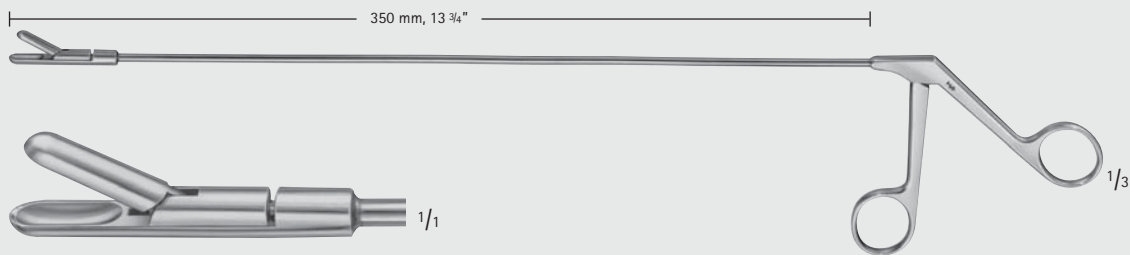

LLOYD-DAVIS

EA900R

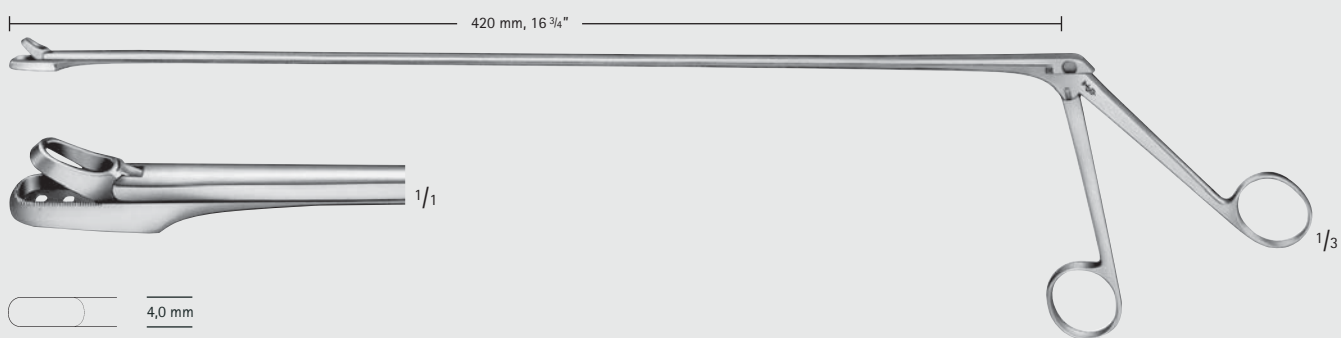

YEOMAN

EA903R

Abdominale Chirurgie – Abdominal Surgery

Darm- und Gewebefasszangen

Intestinal- and Tissue Grasping Forceps

EA



1/1
2 x 3 Zähne, scharf
2 x 3 teeth, sharp

CHAPUT

BF300R

125 mm, 5"



1/1
5 x 6 Zähne, scharf
5 x 6 teeth, sharp

TUFFIER

BF301R

125 mm, 5"

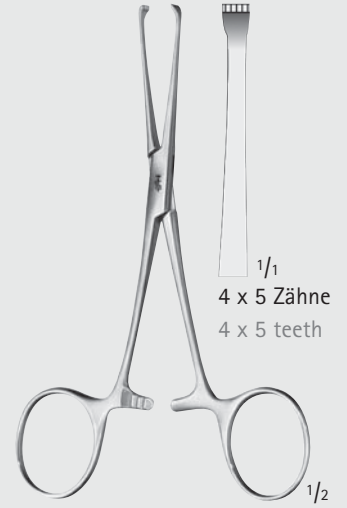

1/1
4 x 5 Zähne
4 x 5 teeth

BABY-ALLIS

EA012R

130 mm, 5 1/8"

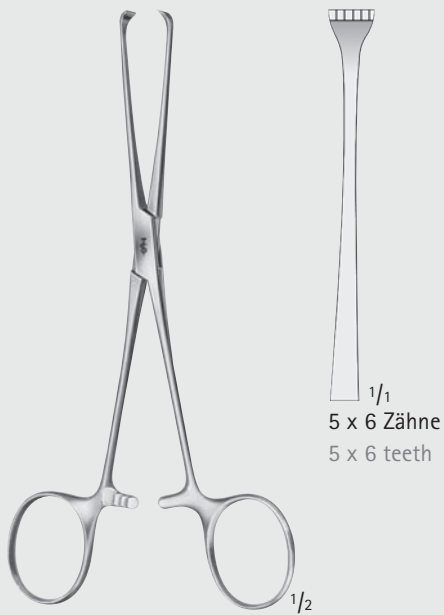

1/1
5 x 6 Zähne
5 x 6 teeth

BOYS-ALLIS

EA010R

155 mm, 6"

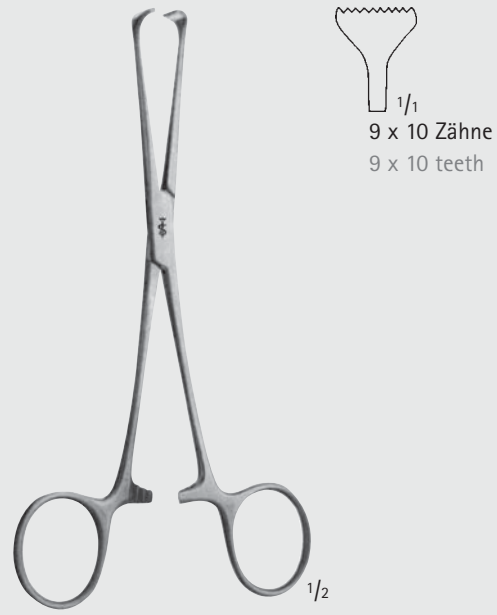

1/1
9 x 10 Zähne
9 x 10 teeth

ALLIS-ADAIR

MD568

160 mm, 6 1/4"



Abdominale Chirurgie – Abdominal Surgery

Darm- und Gewebefasszangen Intestinal- and Tissue Grasping Forceps

EA



EA013R

2 x 3 Zähne
2 x 3 teeth

EA014R

3 x 4 Zähne
3 x 4 teeth

EA015R

4 x 5 Zähne
4 x 5 teeth

ALLIS

EA013R-EA015R

155 mm, 6"

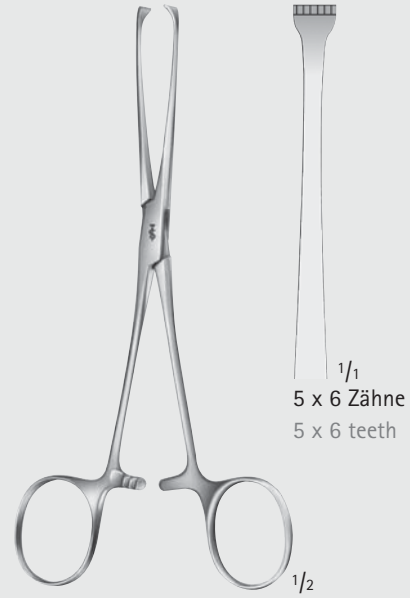

$\frac{1}{1}$

5 x 6 Zähne
5 x 6 teeth

ALLIS

EA016R

155 mm, 6"



EA017R

190 mm
7 1/2"

EA018R

255 mm
10"

ALLIS

EA017R-EA018R

5 x 6 Zähne
zarte Modelle
5 x 6 teeth
slender patterns

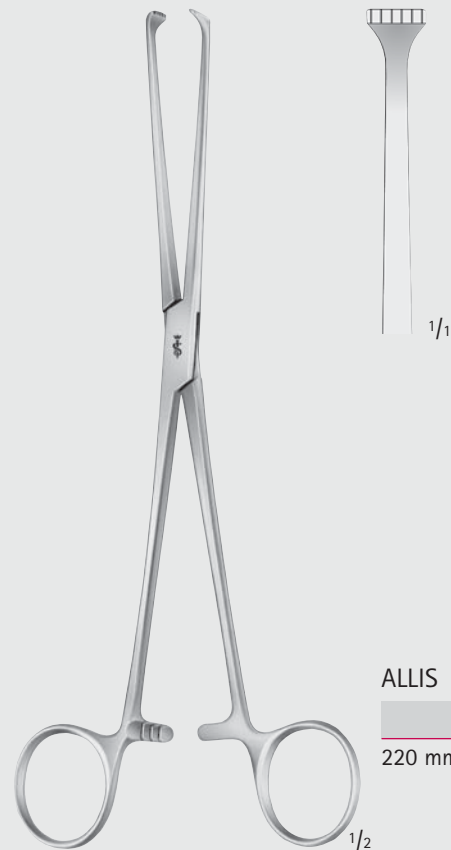

$\frac{1}{1}$

ALLIS

FB938R

220 mm, 8 3/4"



MILLIMETERS

General Surgery

Abdominal and Intestinal Grasping Forceps



EA022R-EA023R

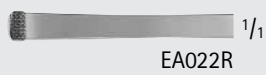

EA022R

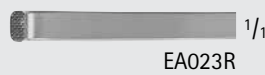

EA023R

ALLIS Intestinal Grasping Forceps

Catalog Number	Length (in.)
EA022R	7 1/2
EA023R	11 1/2



General Surgery

Abdominal and Intestinal Grasping Forceps

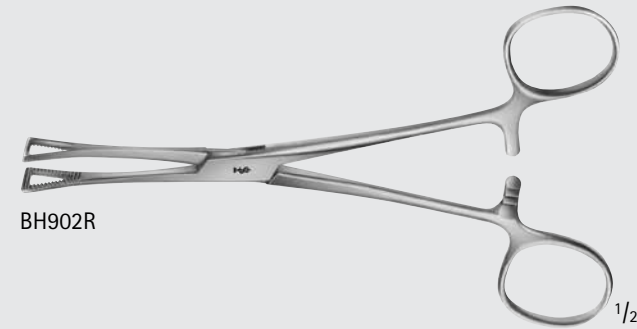

BH902R

1/2



BH902R

1/1

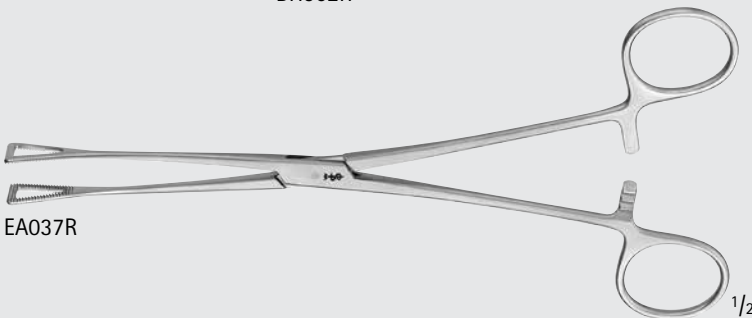

EA037R

1/2

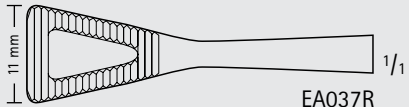

EA037R

11 mm

1/1

PENNINGTON Forceps

Catalog Number	Length (in.)
BH902R	6 1/8
EA037R	7 7/8

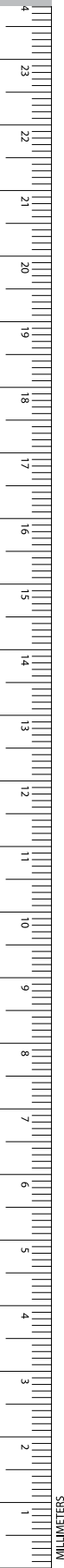

General Surgery

Abdominal and Intestinal Forceps



Purse String Clamp

Catalog Number	Jaw Length (mm)	Length (in.)
EA323R	50	11



EA323R

1/2

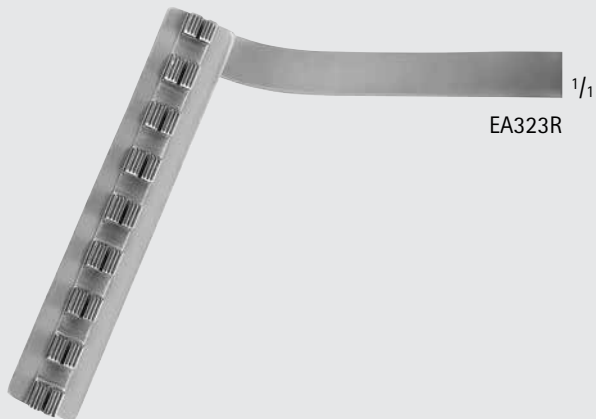

EA323R

1/1



Abdominale Chirurgie – Abdominal Surgery
 Darmfazzangen
 Intestinal Grasping Forceps

EA

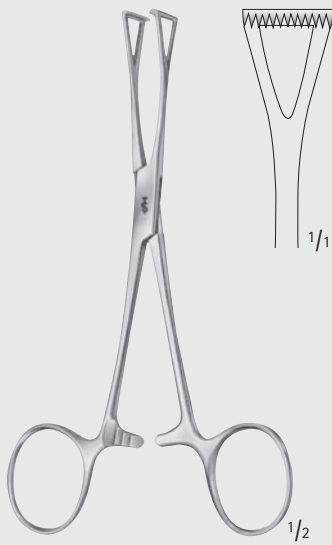

COLLIN

EA039R

140 mm, 5 1/2"

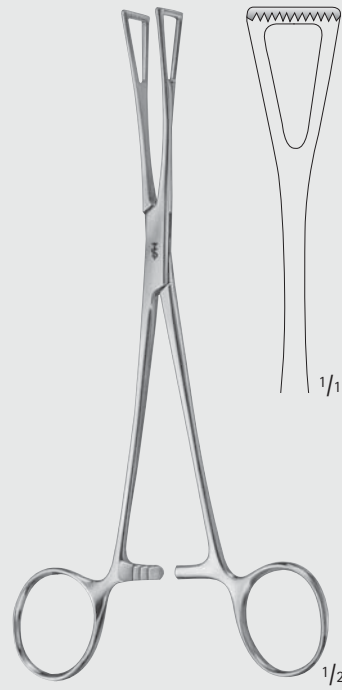

COLLIN

EA040R

180 mm, 7"

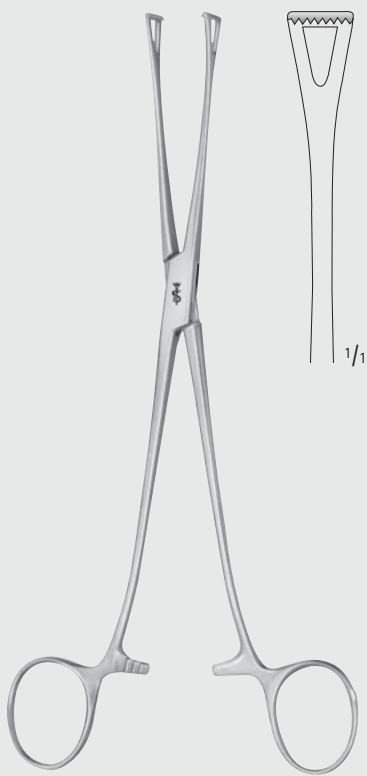

LOCKWOOD

EA036R

1/2 200 mm, 8"

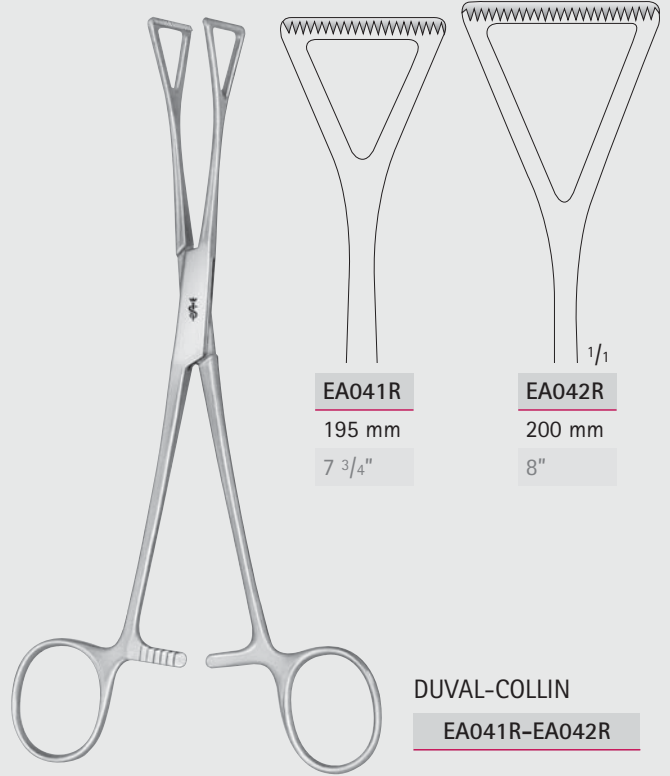

EA041R

195 mm

7 3/4"

EA042R

200 mm

8"

DUVAL-COLLIN

EA041R-EA042R



Abdominale Chirurgie – Abdominal Surgery

Darmfazzangen

Intestinal Grasping Forceps

EA

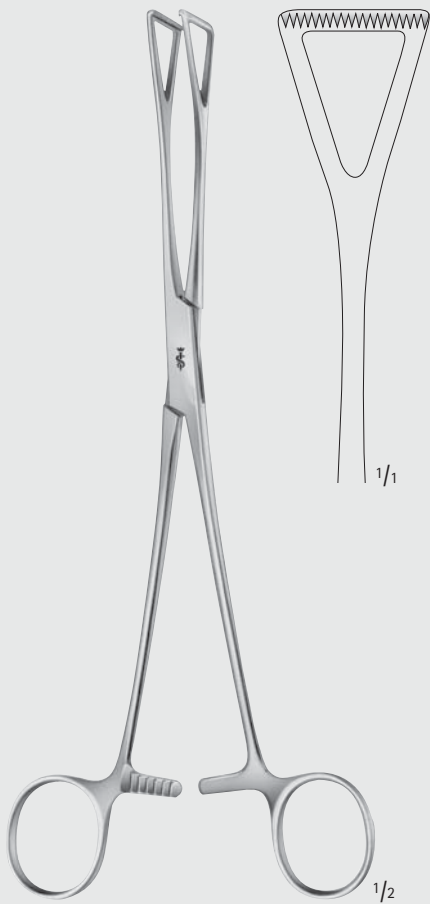

DUVAL

FB930R

230 mm, 9"

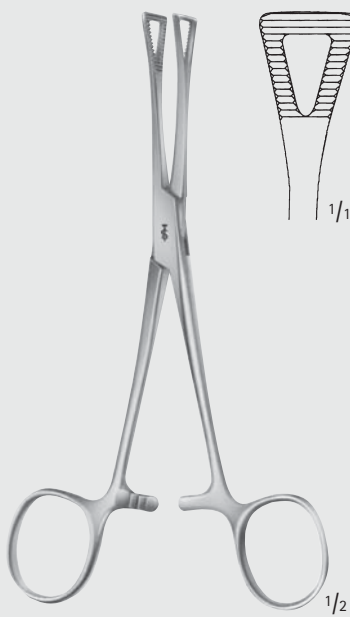

PENNINGTON

BH902R

155 mm, 6"



PENNINGTON

EA037R

200 mm, 8"

INCHES



Abdominale Chirurgie – Abdominal Surgery
Hämorrhoidenklemmen
Hemorrhoidal Forceps

EA

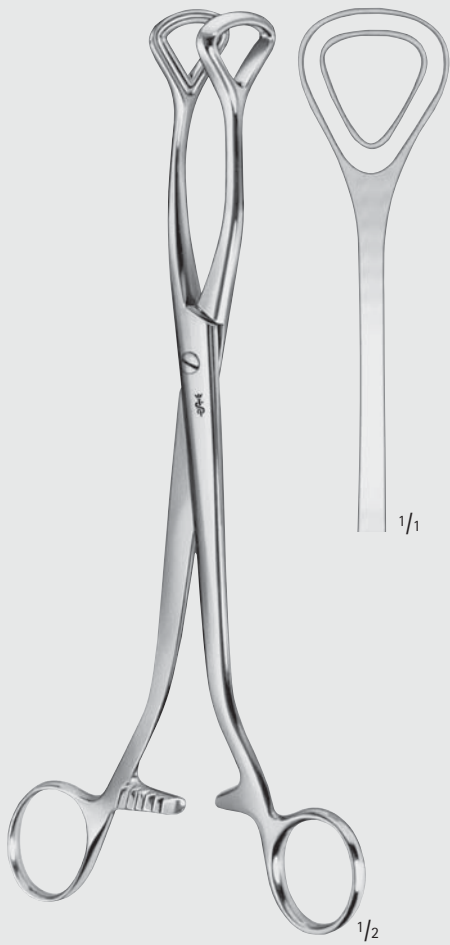

LUER

EA989R

245 mm, 9 3/4"

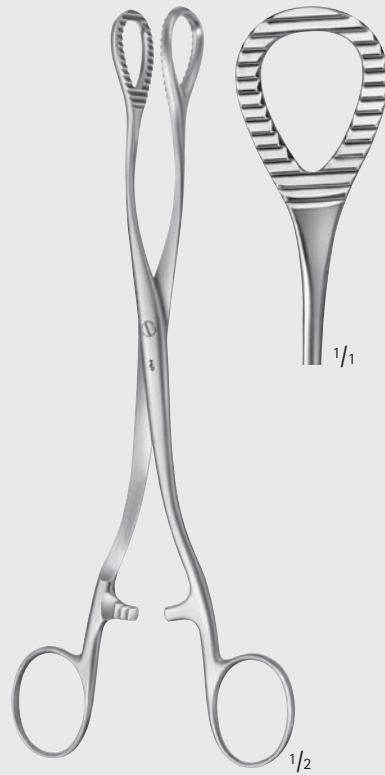

HEYWOOD-SMITH

AN710R

200 mm, 8"

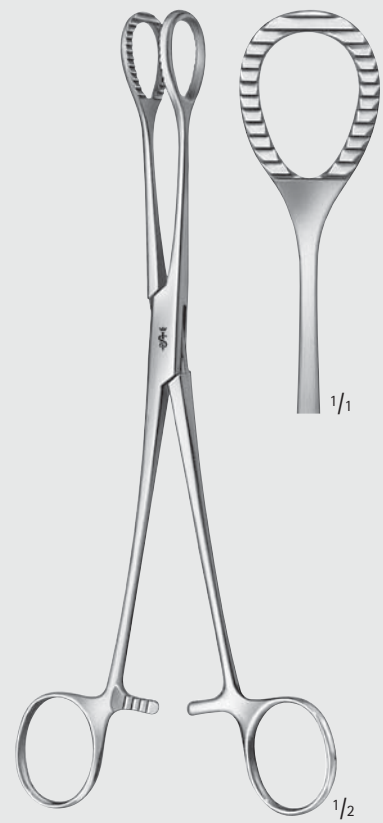

HEYWOOD-SMITH MODIF.

AN711R

215 mm, 8 1/2"

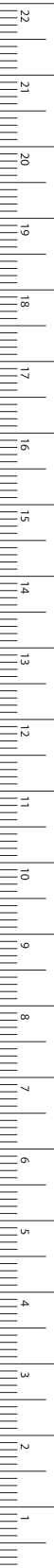

MILLIMETERS

Abdominale Chirurgie – Abdominal Surgery

Hämorrhoidenklemmen

Hemorrhoidal Forceps

EA



ARAUMATA®

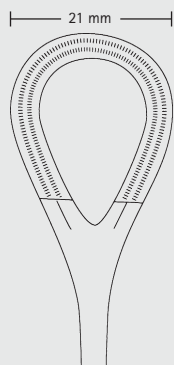

E0338R
250 mm
10"

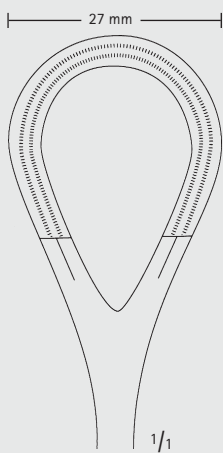

E0340R
270 mm
10 3/4"

E0338R-E0340R

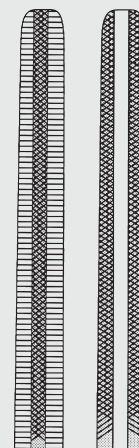

VC100R

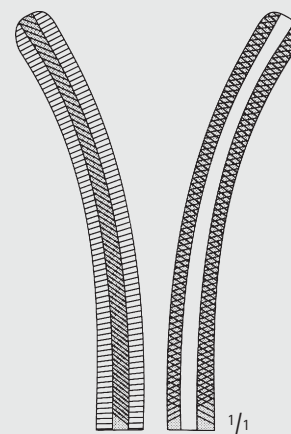

VC101R



FERGUSON

VC100R-VC101R

Druckklemmen
Pressure clamps
200 mm, 8"

Abdominale Chirurgie – Abdominal Surgery

Magen- und Darm- Zwillingsklemmen

Gastro- Intestinal Forceps, Twin

EA



LANE

EA440R

310 mm, 12"



LANE

EA441R

310 mm, 12"



Korn- und Tupferzangen – Sponge- and Dressing Forceps Organ- und Gewebefasszangen Organ- and Tissue Grasping Forceps

BF

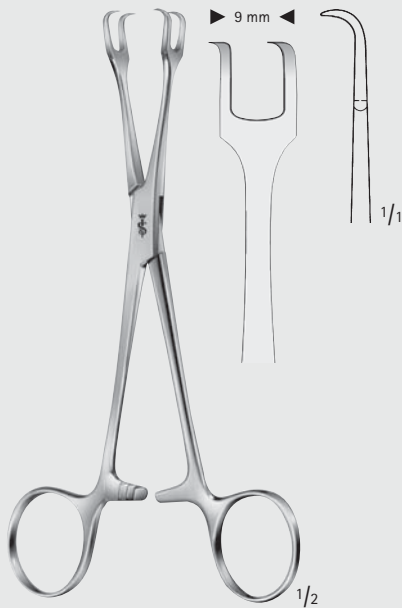

LAHEY

BF309R

155 mm, 6"

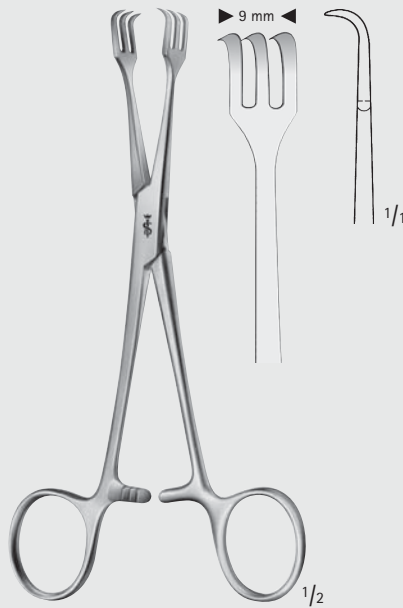

LAHEY

BF310R

155 mm, 6"

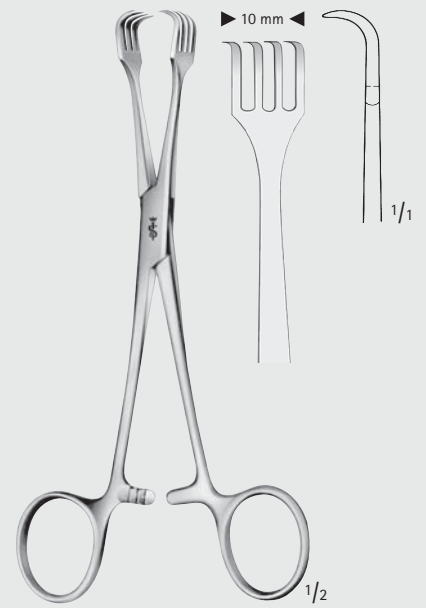

BRAUN

BF311R

155 mm, 6"

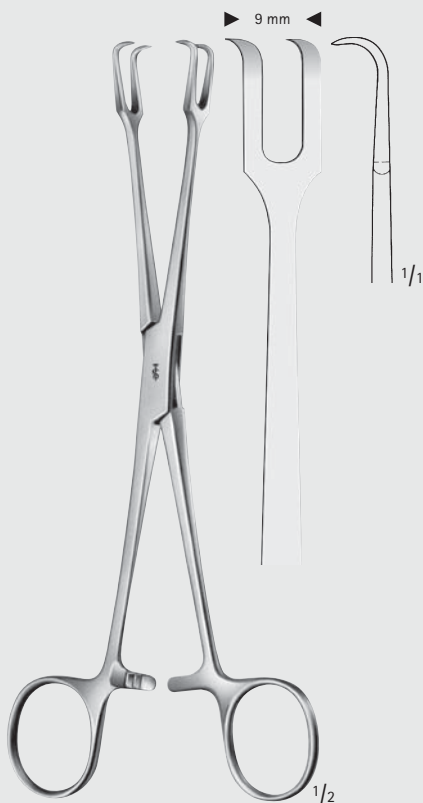

MUSEUX

OM602R

200 mm, 8"

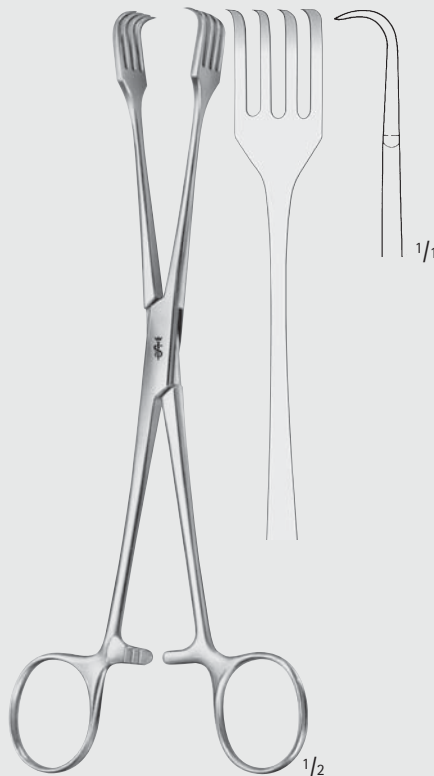

CZERNY

E0164R

200 mm, 8"

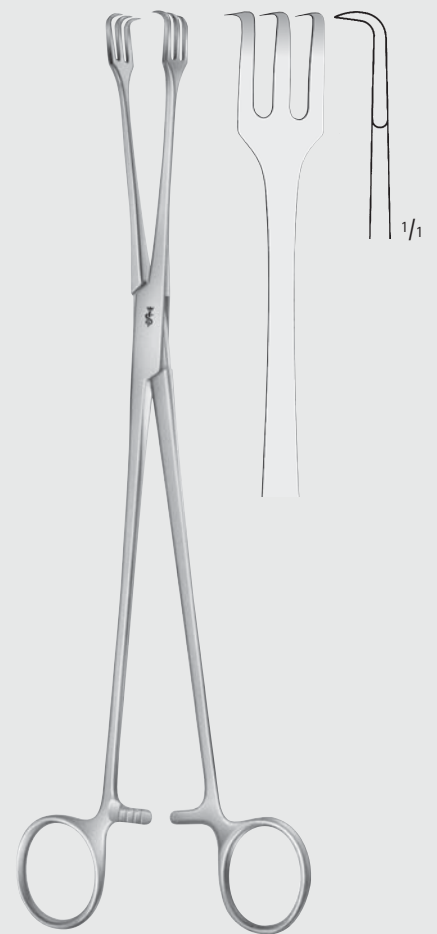

SCHRÖDER

E0163R

270 mm, 10 3/4"



MILLIMETERS

Korn- und Tupferzangen – Sponge- and Dressing Forceps
Organ- und Gewebefasszangen
Organ- and Tissue Grasping Forceps

BF

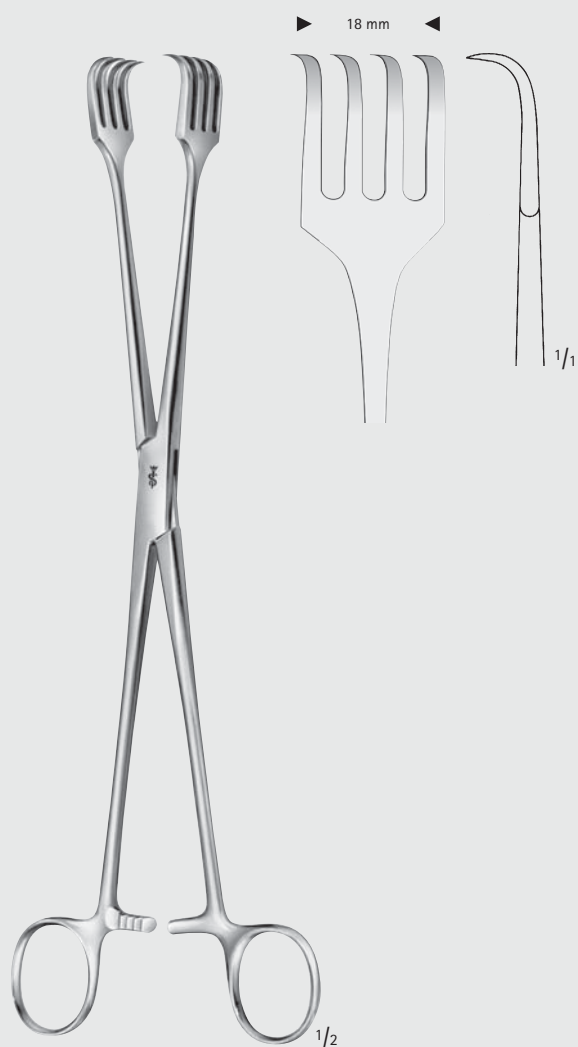

AESCULAP-PRATT

EO165R

260 mm, 10 1/4"

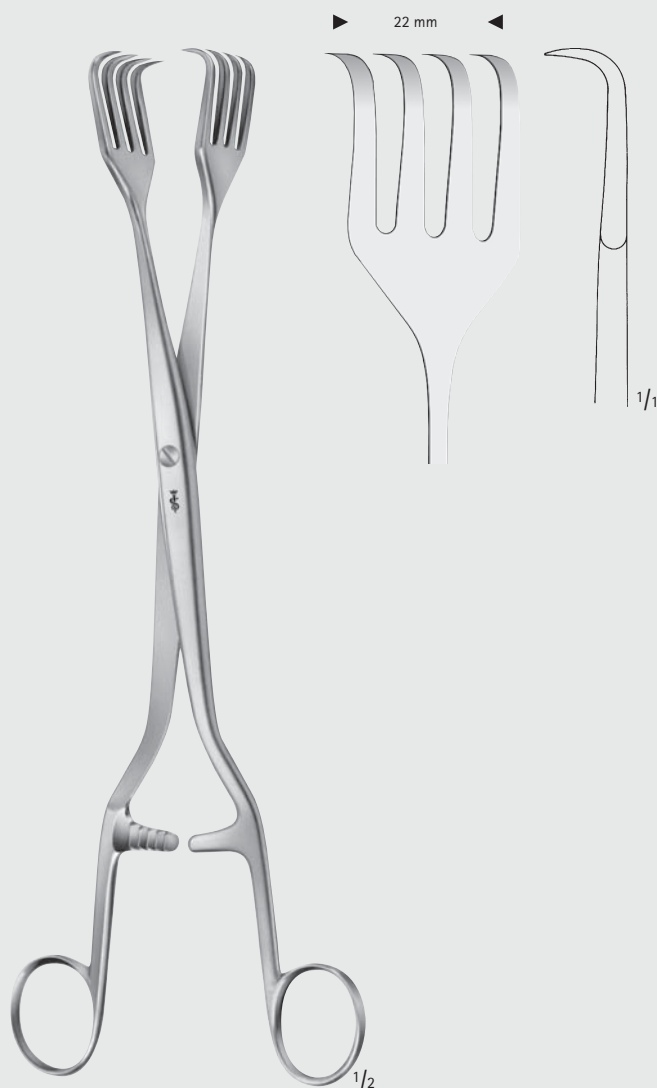

PRATT

EO166R

270 mm, 10 3/4"



Korn- und Tupferzangen – Sponge- and Dressing Forceps
Organ- und Gewebefasszangen
Organ- and Tissue Grasping Forceps

BF

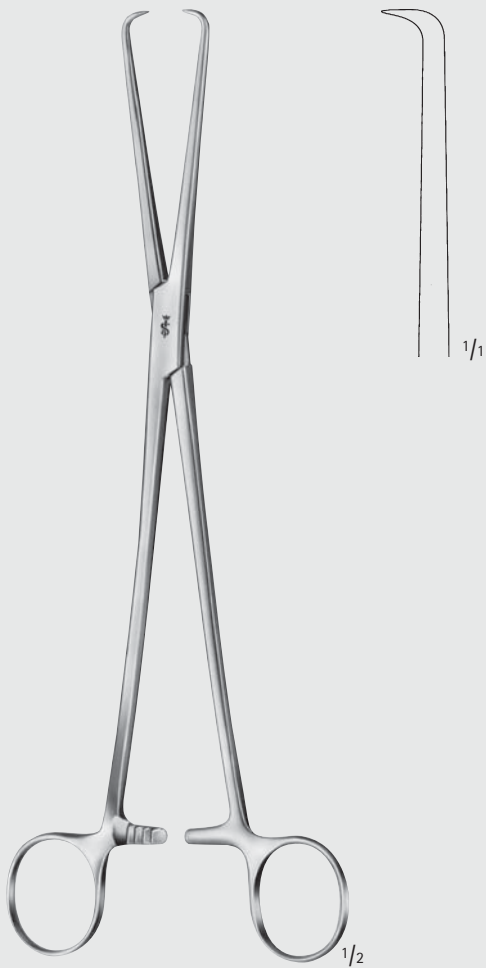

SCHRÖDER

E0110R

250 mm, 10"

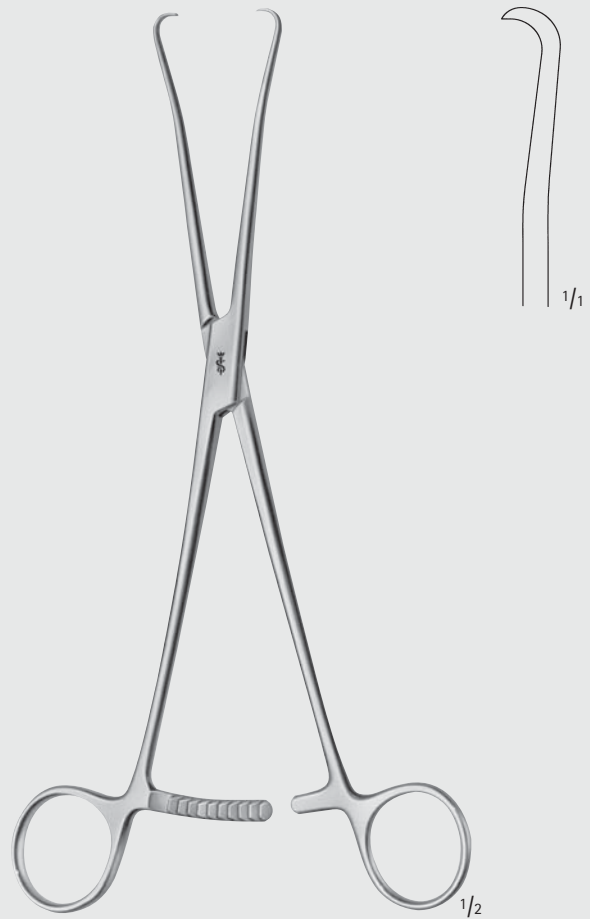

WILSON

E0112R

240 mm, 9 1/2"



MILLIMETERS

Abdominale Chirurgie – Abdominal Surgery

Organ- und Gewebefasszangen

Organ- and Tissue Grasping Forceps

EA

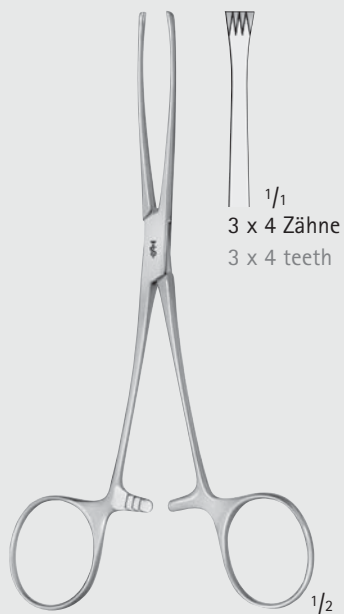

1/1
3 x 4 Zähne
3 x 4 teeth

JUDD-ALLIS

EA025R

155 mm, 6"



1/1
3 x 4 Zähne
3 x 4 teeth

JUDD-ALLIS

EA026R

195 mm, 7 3/4"

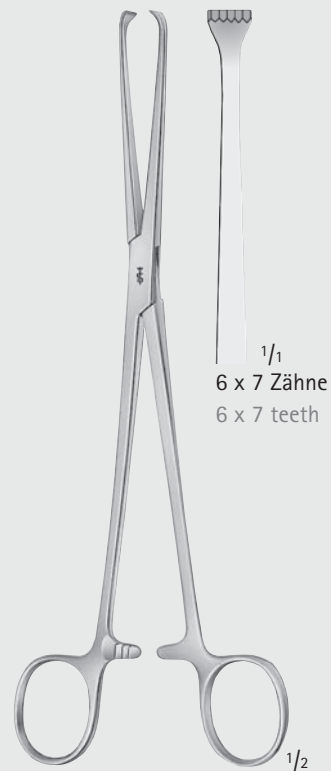

1/1
6 x 7 Zähne
6 x 7 teeth

ALLIS-THOMS

EA020R

200 mm, 8"

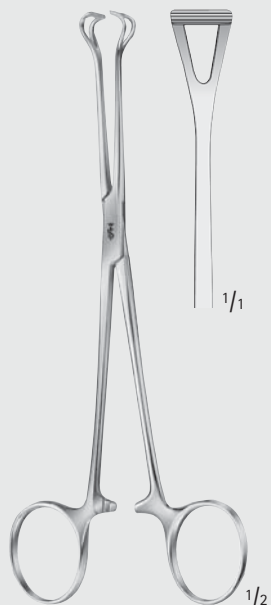

1/1

BABCOCK

EA030R

155 mm, 6"



1/1

EA031R	EA032R	EA033R
170 mm	215 mm	200 mm
6 3/4"	8 1/2"	8"

BABCOCK

EA031R-EA033R



1/1

BABCOCK

FB934R

220 mm, 8 3/4"



Abdominale Chirurgie – Abdominal Surgery
 Darmfazzangen
 Intestinal Grasping Forceps

EA

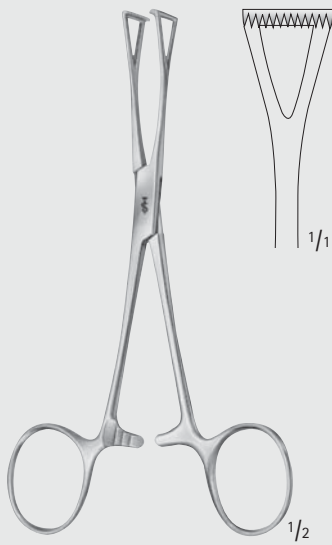

COLLIN

EA039R

140 mm, 5 1/2"

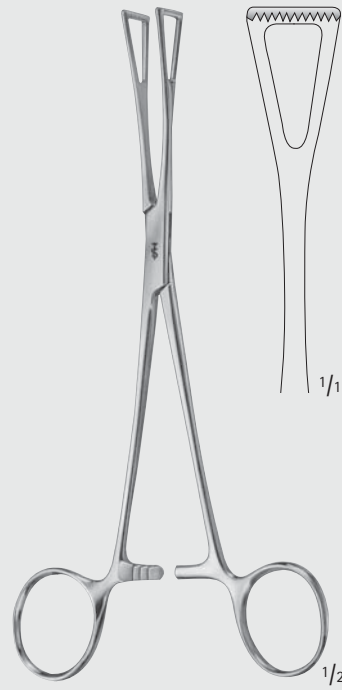

COLLIN

EA040R

180 mm, 7"

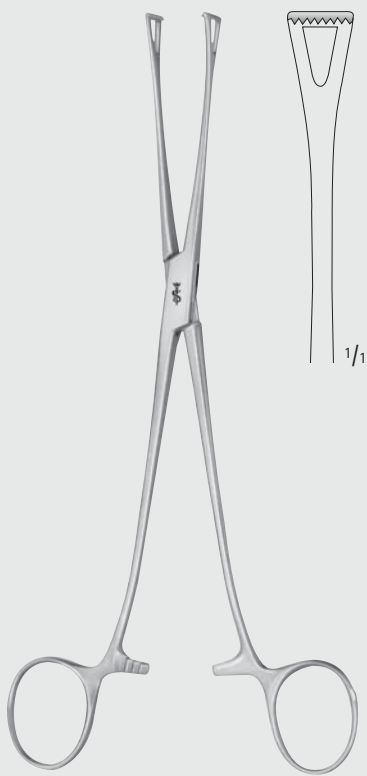

LOCKWOOD

EA036R

200 mm, 8"

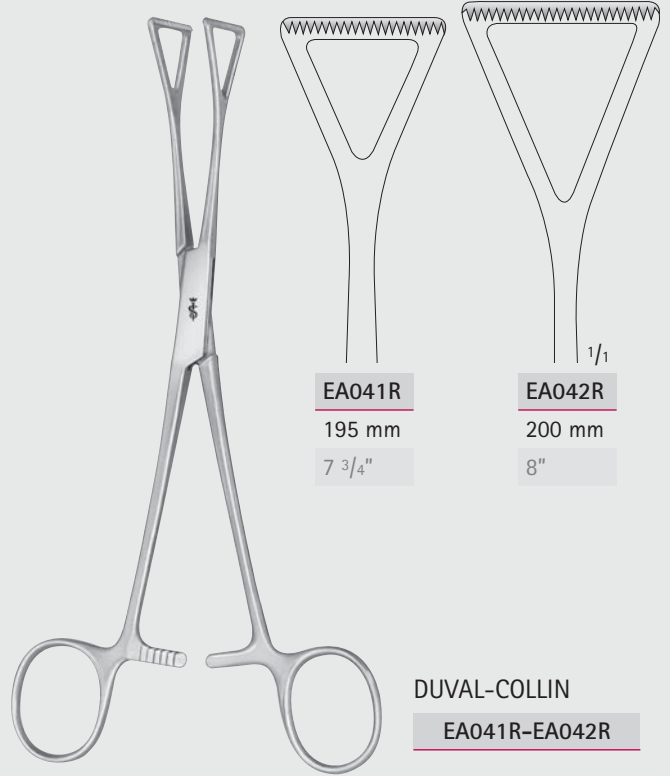

EA041R

195 mm

7 3/4"

EA042R

200 mm

8"

DUVAL-COLLIN

EA041R-EA042R





DE BAKEY Zahnung



Toothing DE BAKEY

APRAUMATA®

Herz- und Gefäß-Chirurgie – Cardiovascular Surgery

Gewebe- und Organfasszangen

Tissue- and Organ Grasping Forceps

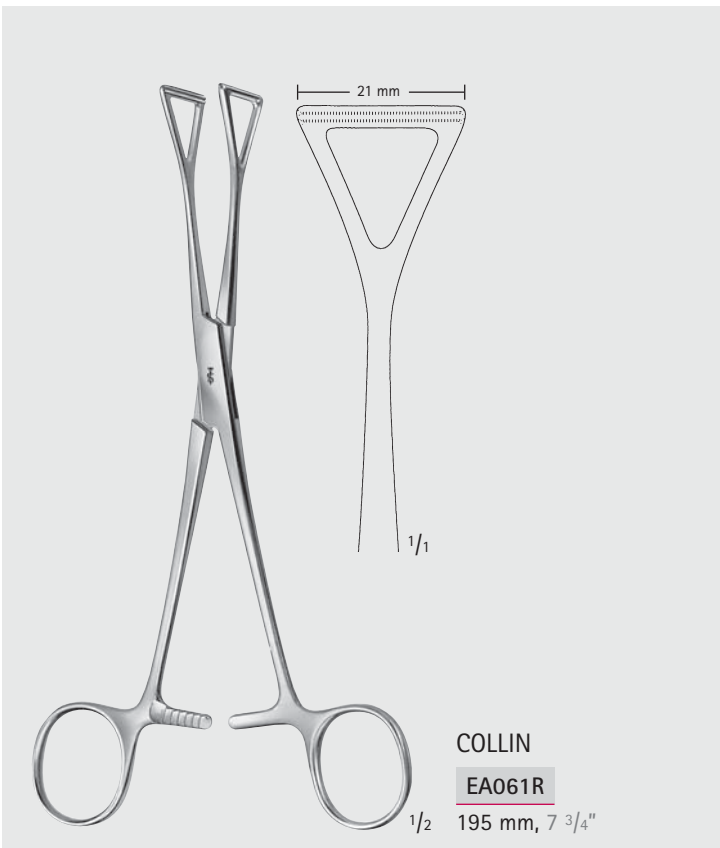
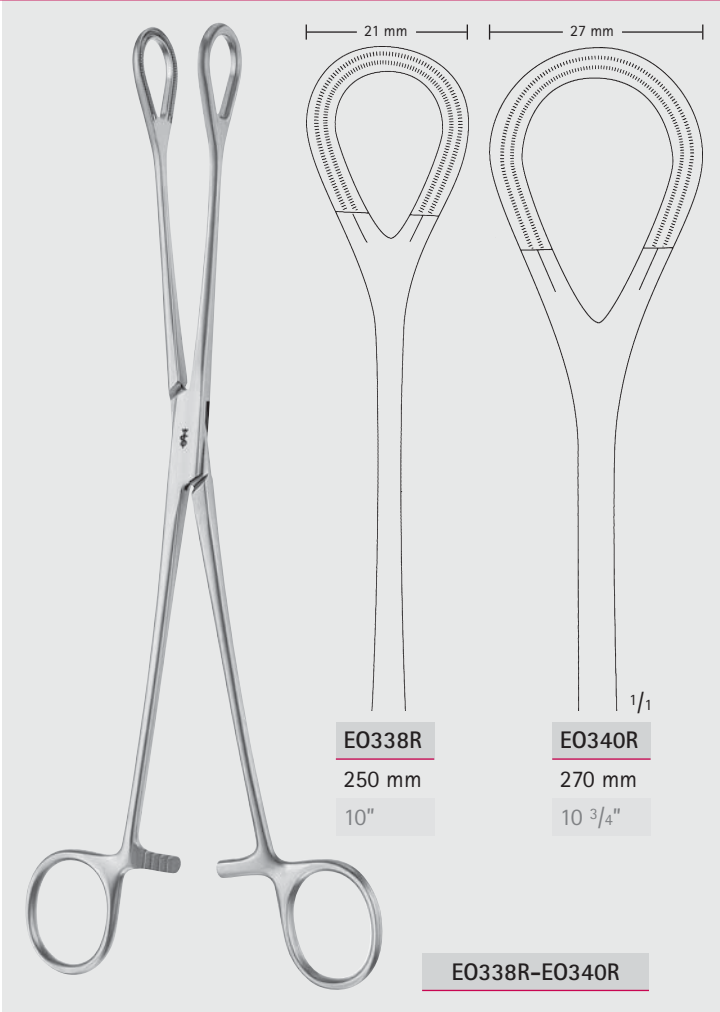

FB

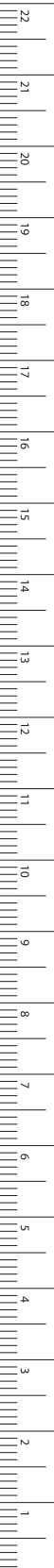

MILLIMETERS



Abdominale Chirurgie – Abdominal Surgery

Rektum-Anastomosenklemmen

Sigmoid Anastomosis Forceps

EA



BRUNNER

EA191R

245 mm, 9 3/4"



FB954R

60 mm

FB955R

80 mm

FB954R-FB955R

230 mm, 9"



MILLIMETERS

Abdominale Chirurgie – Abdominal Surgery

Rektum-Anastomosenklemmen

Sigmoid Anastomosis Forceps

TRAUMATA®

EA

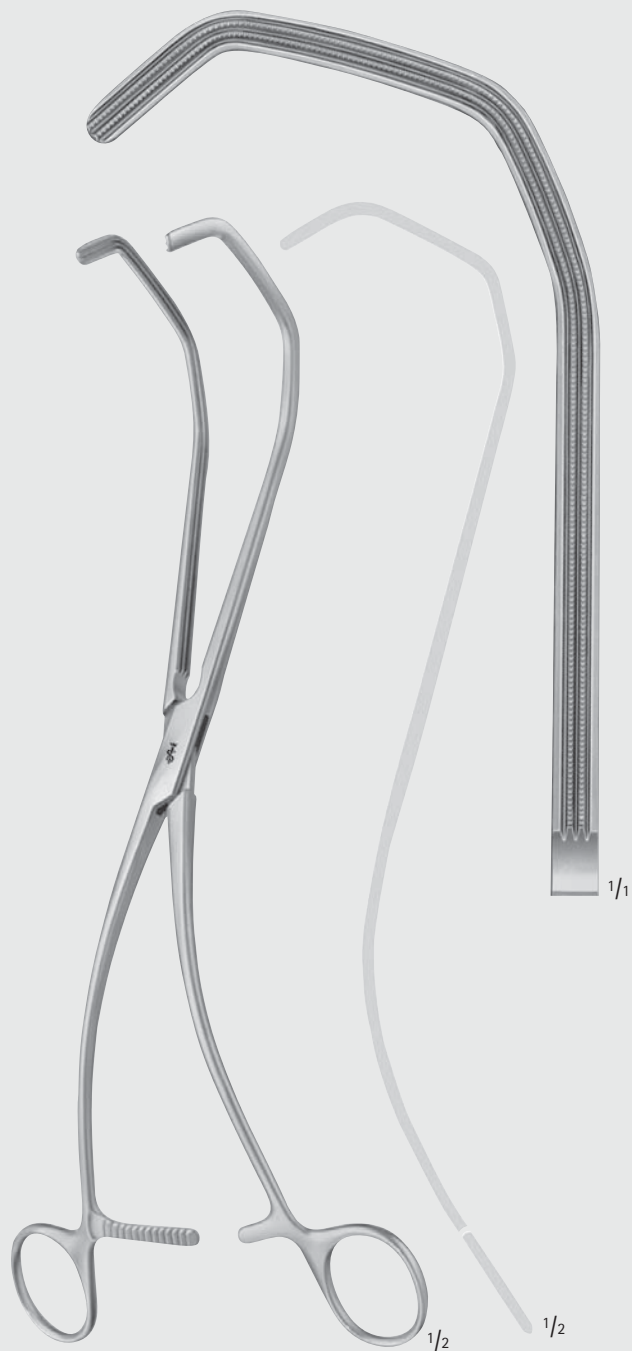

KERSTING

EA355R

300 mm, 12"



RESANO

EA360R

elastisch

elastic

265 mm, 10 1/2"

Neurosurgery

Pituitary Instruments

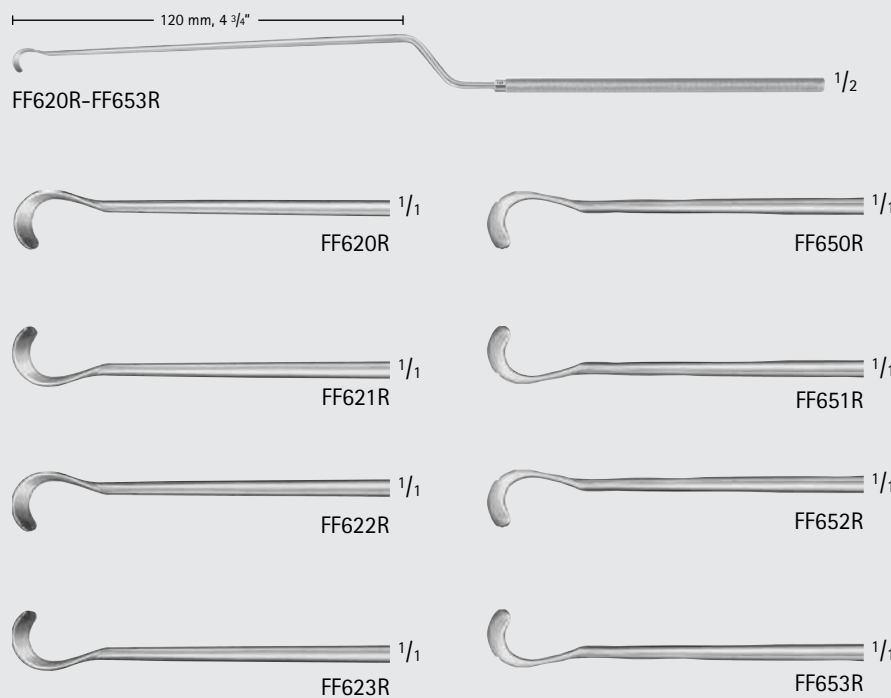

HARDY Enucleator, Bayonet-Shaped

Catalog Number	Tip	Working Length (in.)	Length (in.)
FF620R	CVD-RIGHT, CUT-RIGHT, BLUNT	4 3/4	9 5/8
FF621R	CVD-LEFT, CUT-RIGHT, BLUNT	4 3/4	9 5/8
FF622R	CVD-RIGHT, CUT-RIGHT, SHARP	4 3/4	9 5/8
FF623R	CVD-LEFT, CUT-RIGHT, SHARP	4 3/4	9 5/8
FF650R	CVD-RIGHT, CUT-LEFT, BLUNT	4 3/4	9 5/8
FF651R	CVD-LEFT, CUT-LEFT, BLUNT	4 3/4	9 5/8
FF652R	CVD-RIGHT, CUT-LEFT, SHARP	4 3/4	9 5/8
FF653R	CVD-LEFT, CUT-LEFT, SHARP	4 3/4	9 5/8



Neurosurgery

Pituitary Instruments



HARDY Implant Fork, Bayonet-Shaped

Catalog Number	Working Length (in.)	Length (in.)
FF624R	4 3/4	9 5/8

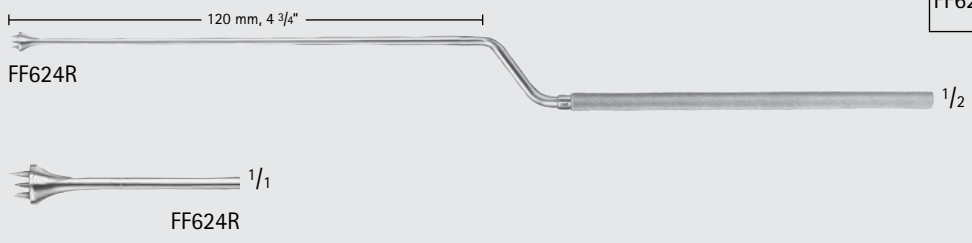

Neurosurgery

Pituitary Instruments



LANDOLT Enucleator, Malleable, Bayonet-Shaped

Catalog Number	Tip	Working Length (in.)	Length (in.)
FF625R	RIGHT BLUNT DOWN	6 1/8	10 1/4
FF626R	RIGHT BLUNT UP	6 1/8	10 1/4

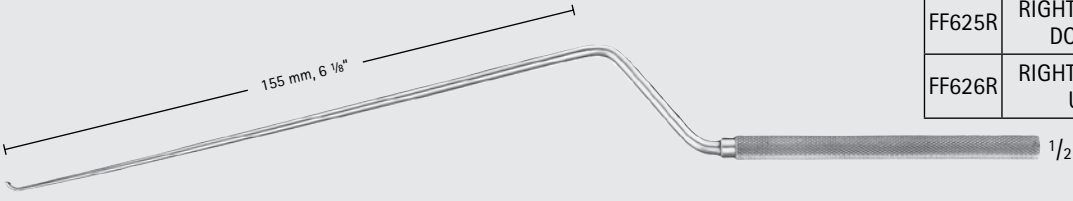

FF625R-FF626R



FF625R



FF626R

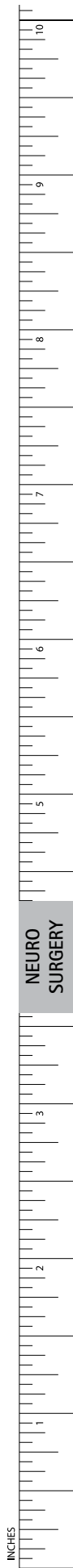

NEURO SURGERY

INCHES



Abdominale Chirurgie – Abdominal Surgery

Organ-, Gewebefasszangen und Pinzetten

Organ-, Tissue Grasping Forceps and Dissecting Forceps

EA

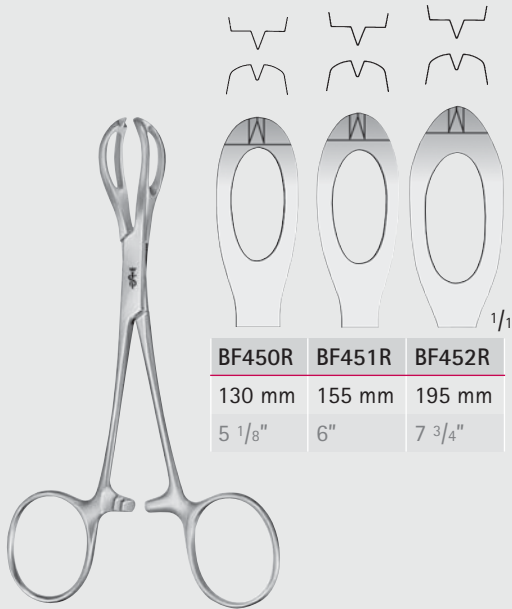

BF450R	BF451R	BF452R
130 mm	155 mm	195 mm
5 1/8"	6"	7 3/4"

LANE

BF450R-BF452R



WILLIAMS

EA028R

160 mm, 6 1/4"



DENIS-BROWNE

EA027R

190 mm, 7 1/2"



DUVAL

BD820R

140 mm, 5 1/2"



BD171R	BD173R
150 mm	230 mm
6"	9"

WANGENSTEIN

BD171R-BD173R



STILLE-BARRAYA

BD725R-BD727R

BD725R	BD726R	BD727R
180 mm	200 mm	250 mm
7"	8"	10"
3 x 4 Zähne 3 x 4 teeth	3 x 4 Zähne 3 x 4 teeth	4 x 5 Zähne 4 x 5 teeth



MILLIMETERS

По вопросам продаж и поддержки обращайтесь:

Алматы (7273)495-231	Казань (843)206-01-48	Новокузнецк (3843)20-46-81	Смоленск (4812)29-41-54
Архангельск (8182)63-90-72	Калининград (4012)72-03-81	Новосибирск (383)227-86-73	Сочи (862)225-72-31
Астрахань (8512)99-46-04	Калуга (4842)92-23-67	Омск (3812)21-46-40	Ставрополь (8652)20-65-13
Барнаул (3852)73-04-60	Кемерово (3842)65-04-62	Орел (4862)44-53-42	Сургут (3462)77-98-35
Белгород (4722)40-23-64	Киров (8332)68-02-04	Оренбург (3532)37-68-04	Тверь (4822)63-31-35
Брянск (4832)59-03-52	Краснодар (861)203-40-90	Пенза (8412)22-31-16	Томск (3822)98-41-53
Владивосток (423)249-28-31	Красноярск (391)204-63-61	Пермь (342)205-81-47	Тула (4872)74-02-29
Волгоград (844)278-03-48	Курск (4712)77-13-04	Ростов-на-Дону (863)308-18-15	Тюмень (3452)66-21-18
Вологда (8172)26-41-59	Липецк (4742)52-20-81	Рязань (4912)46-61-64	Ульяновск (8422)24-23-59
Воронеж (473)204-51-73	Магнитогорск (3519)55-03-13	Самара (846)206-03-16	Уфа (347)229-48-12
Екатеринбург (343)384-55-89	Москва (495)268-04-70	Санкт-Петербург (812)309-46-40	Хабаровск (4212)92-98-04
Иваново (4932)77-34-06	Мурманск (8152)59-64-93	Саратов (845)249-38-78	Челябинск (351)202-03-61
Ижевск (3412)26-03-58	Набережные Челны (8552)20-53-41	Севастополь (8692)22-31-93	Череповец (8202)49-02-64
Иркутск (395)279-98-46	Нижний Новгород (831)429-08-12	Симферополь (3652)67-13-56	Ярославль (4852)69-52-93
Россия (495)268-04-70	Киргизия (996)312-96-26-47	Казахстан (7172)727-132	