

Технические характеристики

По вопросам продаж и поддержки обращайтесь:

Алматы (7273)495-231	Казань (843)206-01-48	Новокузнецк (3843)20-46-81	Смоленск (4812)29-41-54
Архангельск (8182)63-90-72	Калининград (4012)72-03-81	Новосибирск (383)227-86-73	Сочи (862)225-72-31
Астрахань (8512)99-46-04	Калуга (4842)92-23-67	Омск (3812)21-46-40	Ставрополь (8652)20-65-13
Барнаул (3852)73-04-60	Кемерово (3842)65-04-62	Орел (4862)44-53-42	Сургут (3462)77-98-35
Белгород (4722)40-23-64	Киров (8332)68-02-04	Оренбург (3532)37-68-04	Тверь (4822)63-31-35
Брянск (4832)59-03-52	Краснодар (861)203-40-90	Пенза (8412)22-31-16	Томск (3822)98-41-53
Владивосток (423)249-28-31	Красноярск (391)204-63-61	Пермь (342)205-81-47	Тула (4872)74-02-29
Волгоград (844)278-03-48	Курск (4712)77-13-04	Ростов-на-Дону (863)308-18-15	Тюмень (3452)66-21-18
Вологда (8172)26-41-59	Липецк (4742)52-20-81	Рязань (4912)46-61-64	Ульяновск (8422)24-23-59
Воронеж (473)204-51-73	Магнитогорск (3519)55-03-13	Самара (846)206-03-16	Уфа (347)229-48-12
Екатеринбург (343)384-55-89	Москва (495)268-04-70	Санкт-Петербург (812)309-46-40	Хабаровск (4212)92-98-04
Иваново (4932)77-34-06	Мурманск (8152)59-64-93	Саратов (845)249-38-78	Челябинск (351)202-03-61
Ижевск (3412)26-03-58	Набережные Челны (8552)20-53-41	Севастополь (8692)22-31-93	Череповец (8202)49-02-64
Иркутск (395)279-98-46	Нижний Новгород (831)429-08-12	Симферополь (3652)67-13-56	Ярославль (4852)69-52-93
Россия (495)268-04-70	Киргизия (996)312-96-26-47	Казахстан (7172)727-132	

Arterienklemmen – Hemostatic Forceps

Gefäßclips nach BIEMER, Gefäßclips nach MEHDORN, Minigröße
BIEMER Vessel Clips, MEHDORN Vessel Clips, Mini Size

für temporären Gebrauch

- Maulinnenflächen schräg gerieft, für schonendes, sicheres Festhalten der Gefäße.
- Der fest eingestellte Schließdruck gewährt risikofreie Anwendung.
- Schließkraft-Ermittlung: bei $\frac{1}{3}$ der Gesamtauflänge von vorn und einer Maulöffnung von 1 mm (siehe Zeichnung)

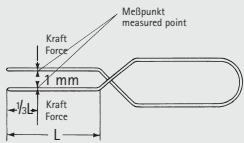

for temporary occlusion

- Blade gripping surface with oblique serrations for safe but careful gripping of vessels.
- No risk due to rigidly fixed pressure measure guarantees application without any risk.
- Closing force is measured at $\frac{1}{3}$ of the blades at 1 mm opening (see illustration).

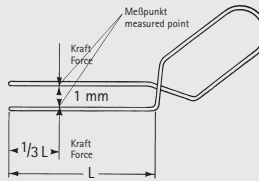

BIEMER

	Maul- öffnung Jaw opening	Maul- länge Jaw length	Schließkraft Closing force	Anlege- pinzette Applying forceps
 FD560R	4 mm	6 mm	30 - 40 g (0,29 - 0,39 N)	FD568R oder / or FD569R
 FD561R	5 mm	9 mm	30 - 40 g (0,29 - 0,39 N)	
 FD562R	5 mm	9 mm	20 - 25 g (0,20 - 0,25 N)	

(gekennzeichnet durch gelb gefärbte Federenden)
für Gefäße mit \varnothing 0,5 - 2,0 mm.

(identified by yellow colored spring ends)
for vessels diam. 0.5 - 2.0 mm.

MEHDORN

	Maul- öffnung Jaw opening	Maul- länge Jaw length	Schließkraft Closing force	Anlege- pinzette Applying forceps
 FD552R	4 mm	1,0 mm	10 - 15 g (0,10 - 0,15 N)	FD578R
 FD554R	4 mm	1,4 mm	15 - 20 g (0,15 - 0,20 N)	
 FD556R	6 mm	1,0 mm	10 - 15 g (0,10 - 0,15 N)	
 FD558R	6 mm	1,4 mm	15 - 20 g (0,15 - 0,20 N)	

(gekennzeichnet durch gelb eingefärbte Federenden)
für Gefäße mit \varnothing 0,5 - 1,5 mm (extra-intracraniale Anastomosen).

(identified by yellow colored spring ends)
for vessels diam. 0.5 - 1.5 mm (extra-intercranial anastomosis).

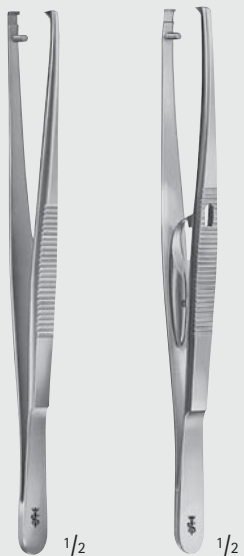

FD568R

ohne Schloss
without lock

FD569R

mit Schloss
with lock

BIEMER

FD568R-FD569R

Anlegepinzetten für Gefäßclips
nach BIEMER und Approximatoren
nach BIEMER-MÜLLER und MÜLLER

Applying forceps for BIEMER vessel
clips and BIEMER-MÜLLER and
MÜLLER approximators

140 mm, 5 1/2"

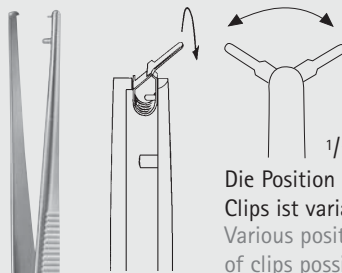

Die Position des
Clips ist variabel
Various positions
of clips possible

MEHDORN

FD578R

Anlegepinzette für Gefäßclips nach MEHDORN

Applying forceps for MEHDORN vessel clips
150 mm, 6"

1/2

Plastic Surgery

Micro Vessel Clips and Clamps

- The arterial clips have a slightly inwards curved jaw tip to prevent slipping, see Fig.1
- The venous clips have a flat parallel closing jaw, see Fig. 2

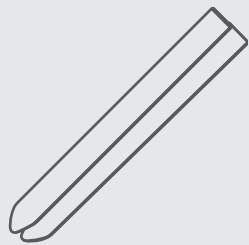

Fig. 1

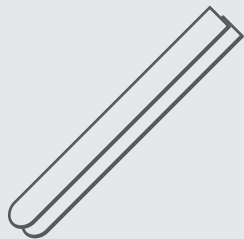
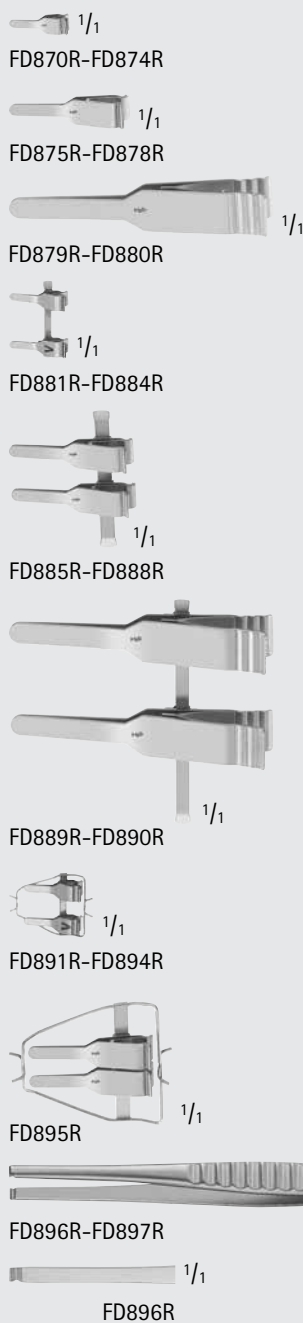

Fig. 2



ACLAND Micro Vessel Clips

Catalog Number	Jaw Length (mm)	Size	Description	Vessel Size (mm)
FD870R	8	B-1	Artery	0.3-1.0
FD871R	8	B-1	Vein	0.3-1.0
FD872R	11	B-2	Artery	0.6-1.4
FD873R	11	B-2	Vein	0.6-1.4
FD874R	16	B-3	Artery	1.0-2.2
FD875R	16	B-3	Vein	1.0-2.2
FD876R	24	HD-S	Artery	1.5-3.3
FD877R	24	HD-S	Vein	1.5-3.3
FD878R	35	RD-S	Artery	2.0-5.0
FD879R	35	RD-S	Vein	2.0-5.0
FD880R	8	B-1	Artery	0.3-1.0
FD881R	8	B-1	Vein	0.3-1.0
FD882R	11	B-2	Artery	0.6-1.4
FD883R	11	B-2	Vein	0.6-1.4
FD884R	16	B-3	Artery	1.0-2.2
FD885R	16	B-3	Vein	1.0-2.2
FD886R	24	HD-D	Artery	1.5-3.3
FD887R	24	HD-D	Vein	1.5-3.3
FD888R	35	RD-D	Artery	2.0-5.0
FD889R	35	RD-D	Vein	2.0-5.0
FD890R	8	B-1	Artery	0.3-1.0
FD891R	8	B-1	Vein	0.3-1.0
FD892R	11	B-2	Artery	0.6-1.4
FD893R	11	B-2	Vein	0.6-1.4
FD894R	16	B-3	Artery	1.0-2.2
FD895R	16	B-3	Vein	1.0-2.2
FD896R	5 1/2	B-1, B-2	Clip Applying Forceps	-
FD897R	5 1/2	B-3, HD, RD	Clip Applying Forceps	-

All items are sold individually

PLASTIC SURGERY

MILLIMETERS

Cardiovascular

Bulldog and Micro Vessel Clamps



SCHWARTZ Apply/Remove Forceps

Catalog Number	Length (in.)
FD628R	7 1/2

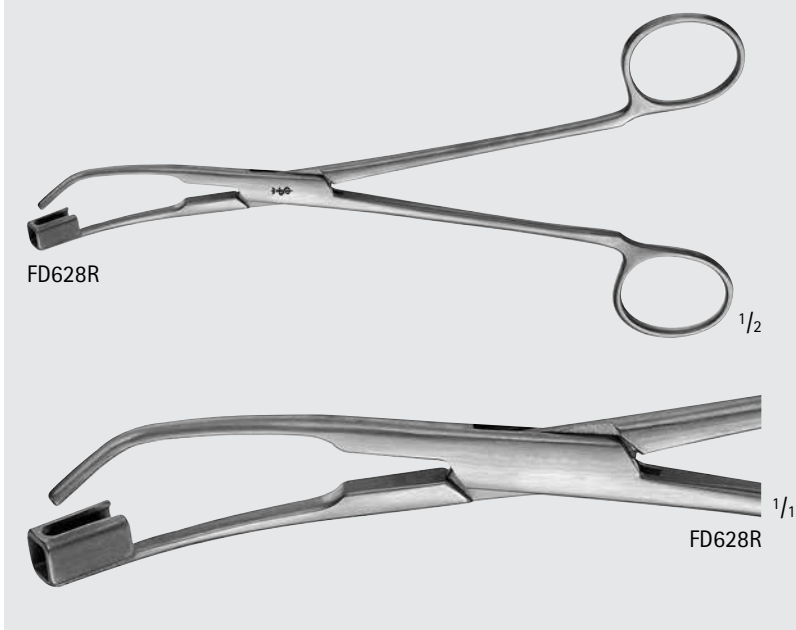

SCHWARTZ Micro-Vessel Clamp, Cross-Serrated



Catalog Number	Jaw	Jaw Length (mm)	Closing Force	Length (in.)
FD622R	STR	8	400G	1
FD623R	25°	8	400G	1
FD624R	45°	8	400G	1

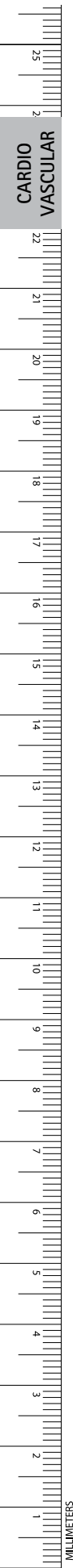

Cardiovascular

Bulldog and Micro Vessel Clamps

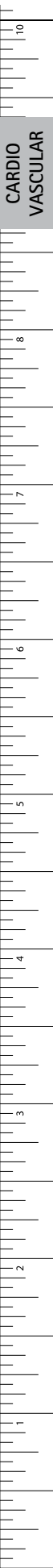

FE010K, FE020K

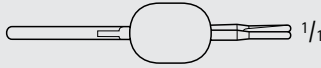

FE010K, FE020K



FE011K, FE021K



FE011K, FE021K



FE012K, FE022K

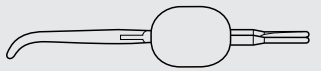

FE012K, FE022K



FE013K, FE023K

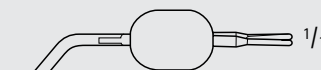

FE013K, FE023K



FE014K, FE024K

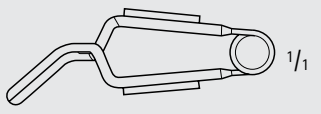

FE014K, FE024K

MUELLER Atraumatic Micro-Vessel Clamp

Catalog Number	Jaw	Closing Force
FE010K	STR	50G
FE020K	STR	80G
FE011K	FULL-CVD	50G
FE021K	FULL-CVD	80G
FE012K	CVD-TIP	50G
FE022K	CVD-TIP	80G
FE013K	ANG	50G
FE023K	ANG	80G
FE014K	LAT-ANG	50G
FE024K	LAT-ANG	80G



FE005K



FE005K

MUELLER Ligature Forceps

Catalog Number	Jaw
FE005K	STR

Cardiovascular

Bulldog and Micro Vessel Clamps

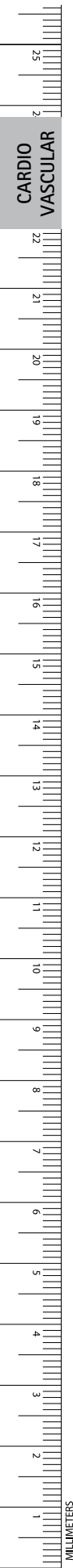

CARDIO
VASCULAR



FE031S, FE041S



FE032S, FE042S



FE030S, FE040S



FE034S, FE044S

MUELLER Alpha Vessel Clamp

Catalog Number	Jaw	Closing Force
FE031S	SLIGHT-CVD	250G
FE041S	SLIGHT-CVD	350G
FE032S	CVD	250G
FE042S	CVD	350G
FE030S	ANG	250G
FE040S	ANG	350G
FE034S	KNEE-BENT	250G
FE044S	KNEE-BENT	350G

По вопросам продаж и поддержки обращайтесь:

Алматы (7273)495-231	Казань (843)206-01-48	Новокузнецк (3843)20-46-81	Смоленск (4812)29-41-54
Архангельск (8182)63-90-72	Калининград (4012)72-03-81	Новосибирск (383)227-86-73	Сочи (862)225-72-31
Астрахань (8512)99-46-04	Калуга (4842)92-23-67	Омск (3812)21-46-40	Ставрополь (8652)20-65-13
Барнаул (3852)73-04-60	Кемерово (3842)65-04-62	Орел (4862)44-53-42	Сургут (3462)77-98-35
Белгород (4722)40-23-64	Киров (8332)68-02-04	Оренбург (3532)37-68-04	Тверь (4822)63-31-35
Брянск (4832)59-03-52	Краснодар (861)203-40-90	Пенза (8412)22-31-16	Томск (3822)98-41-53
Владивосток (423)249-28-31	Красноярск (391)204-63-61	Пермь (342)205-81-47	Тула (4872)74-02-29
Волгоград (844)278-03-48	Курск (4712)77-13-04	Ростов-на-Дону (863)308-18-15	Тюмень (3452)66-21-18
Вологда (8172)26-41-59	Липецк (4742)52-20-81	Рязань (4912)46-61-64	Ульяновск (8422)24-23-59
Воронеж (473)204-51-73	Магнитогорск (3519)55-03-13	Самара (846)206-03-16	Уфа (347)229-48-12
Екатеринбург (343)384-55-89	Москва (495)268-04-70	Санкт-Петербург (812)309-46-40	Хабаровск (4212)92-98-04
Иваново (4932)77-34-06	Мурманск (8152)59-64-93	Саратов (845)249-38-78	Челябинск (351)202-03-61
Ижевск (3412)26-03-58	Набережные Челны (8552)20-53-41	Севастополь (8692)22-31-93	Череповец (8202)49-02-64
Иркутск (395)279-98-46	Нижний Новгород (831)429-08-12	Симферополь (3652)67-13-56	Ярославль (4852)69-52-93
Россия (495)268-04-70	Киргизия (996)312-96-26-47	Казахстан (7172)727-132	