

Технические характеристики

По вопросам продаж и поддержки обращайтесь:

Алматы (7273)495-231	Казань (843)206-01-48	Новокузнецк (3843)20-46-81	Смоленск (4812)29-41-54
Архангельск (8182)63-90-72	Калининград (4012)72-03-81	Новосибирск (383)227-86-73	Сочи (862)225-72-31
Астрахань (8512)99-46-04	Калуга (4842)92-23-67	Омск (3812)21-46-40	Ставрополь (8652)20-65-13
Барнаул (3852)73-04-60	Кемерово (3842)65-04-62	Орел (4862)44-53-42	Сургут (3462)77-98-35
Белгород (4722)40-23-64	Киров (8332)68-02-04	Оренбург (3532)37-68-04	Тверь (4822)63-31-35
Брянск (4832)59-03-52	Краснодар (861)203-40-90	Пенза (8412)22-31-16	Томск (3822)98-41-53
Владивосток (423)249-28-31	Красноярск (391)204-63-61	Пермь (342)205-81-47	Тула (4872)74-02-29
Волгоград (844)278-03-48	Курск (4712)77-13-04	Ростов-на-Дону (863)308-18-15	Тюмень (3452)66-21-18
Вологда (8172)26-41-59	Липецк (4742)52-20-81	Рязань (4912)46-61-64	Ульяновск (8422)24-23-59
Воронеж (473)204-51-73	Магнитогорск (3519)55-03-13	Самара (846)206-03-16	Уфа (347)229-48-12
Екатеринбург (343)384-55-89	Москва (495)268-04-70	Санкт-Петербург (812)309-46-40	Хабаровск (4212)92-98-04
Иваново (4932)77-34-06	Мурманск (8152)59-64-93	Саратов (845)249-38-78	Челябинск (351)202-03-61
Ижевск (3412)26-03-58	Набережные Челны (8552)20-53-41	Севастополь (8692)22-31-93	Череповец (8202)49-02-64
Иркутск (395)279-98-46	Нижний Новгород (831)429-08-12	Симферополь (3652)67-13-56	Ярославль (4852)69-52-93
Россия (495)268-04-70	Киргизия (996)312-96-26-47	Казахстан (7172)727-132	

Orthopedics/Spine

Curettes



CASPAR Bone Curette, Toothed

Catalog Number	Tip Size (mm)	Tip	Length (in.)
FK854R	4.0	SQUARE	9 3/4
FK855R	5.0	SQUARE	9 3/4



FK854R-FK855R

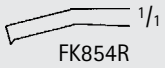

FK854R

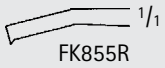

FK855R

CASPAR Bone Curette, Toothed

Catalog Number	Tip Size (mm)	Tip	Length (in.)
FK863R	3.0	SQUARE, ANG	10 5/8
FK864R	4.0	SQUARE, ANG	10 5/8



FK863R-FK864R

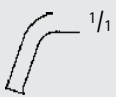

FK863R

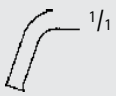

FK864R



MILLER

DO606R

Bone Curette

180 mm, 7"



MILLER

DO771R - DO773R

Bone files

180 mm, 7"



DO771R



5 mm



DO772R



4.3 mm



DO773R



5 mm



Knochenheber, Raspatorien, Scharfe Löffel – Bone Levers, Elevators, Bone Curettes

Scharfe Löffel
Bone Curettes

FK



JACOBSON

FK813R

140 mm, 5 1/2"



MARTINI

FK800R

140 mm, 5 1/2"

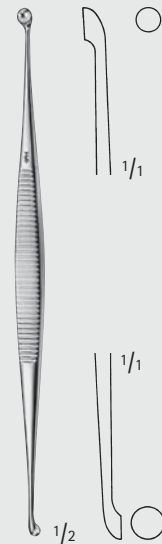

MARTINI

FK801R

140 mm, 5 1/2"



WILLIGER

FK814R

145 mm, 5 3/4"



JANSEN

FK803R

160 mm, 6 1/4"



BARTH

FK817R

180 mm, 7"



FK850R

210 mm, 8 1/4"

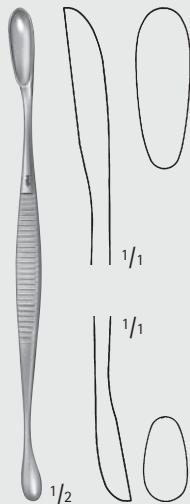

VOLKMANN

FK840R

130 mm, 5 1/8"

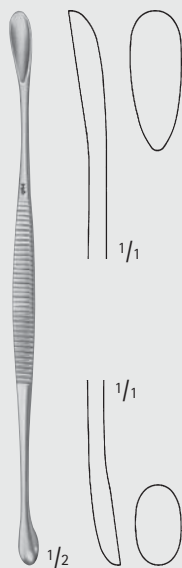

VOLKMANN

FK841R

145 mm, 5 3/4"

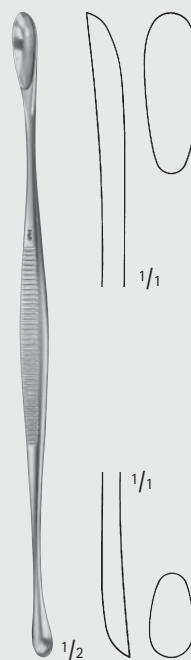

VOLKMANN

FK842R

170 mm, 6 3/4"

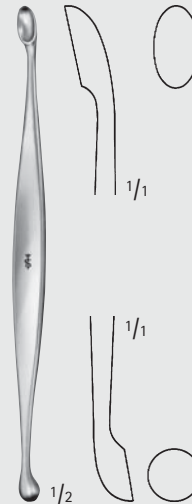

FK845R

130 mm, 5 1/8"

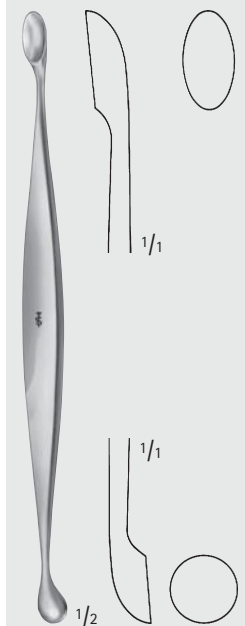

FK846R

160 mm, 6 1/4"



MILLIMETERS

Knochenheber, Raspatorien, Scharfe Löffel – Bone Levers, Elevators, Bone Currettes

Scharfe Löffel

Bone Currettes

FK

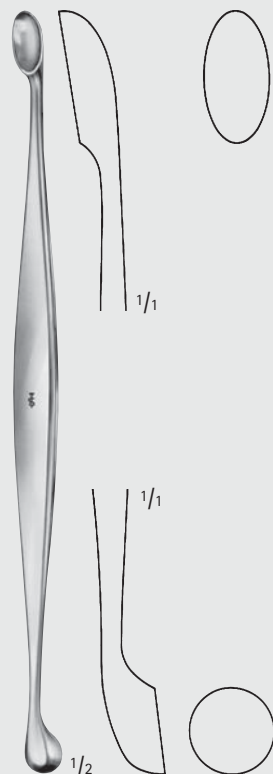

FK848R

200 mm, 8"



DO650R

160 mm, 6 1/4"



JANSEN

DO651R

160 mm, 6 1/4"

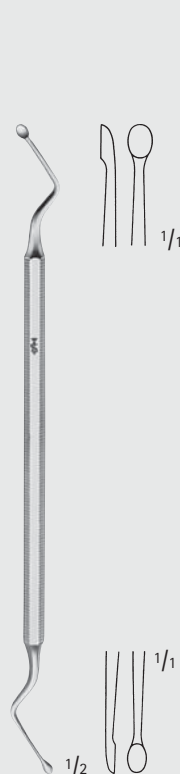

HEMINGWAY

DO655R

170 mm, 6 3/4"

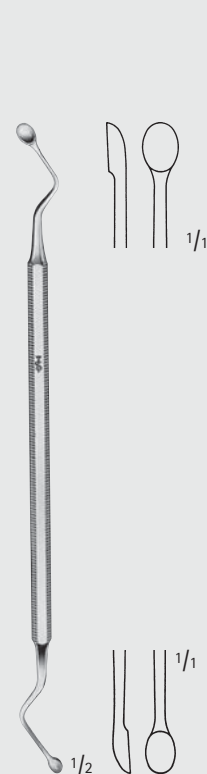

HEMINGWAY

DO656R

170 mm, 6 3/4"

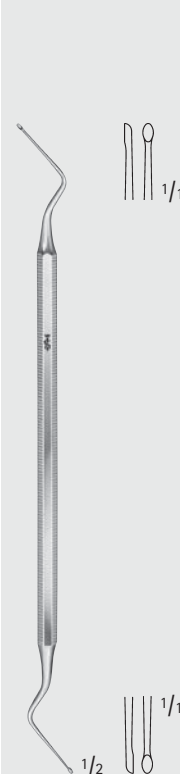

HEMINGWAY

DO670R

Fig. 0
170 mm, 6 3/4"



HEMINGWAY

DO671R

Fig. 1
170 mm, 6 3/4"

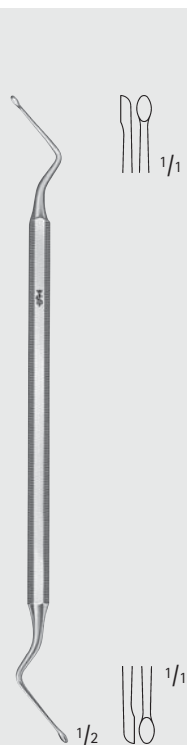

HEMINGWAY

DO672R

Fig. 2
170 mm, 6 3/4"



HEMINGWAY

DO673R

Fig. 3
170 mm, 6 3/4"



HEMINGWAY

DO674R

Fig. 4
170 mm, 6 3/4"



LUCAS

DO608R

180 mm, 7"

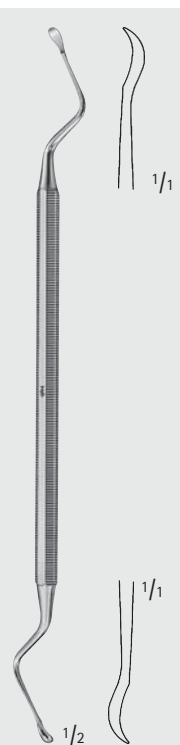

LUCAS

DO609R

185 mm, 7 1/4"



Knochenheber, Raspatorien, Scharfe Löffel – Bone Levers, Elevators, Bone Currettes

Scharfe Löffel
Bone Currettes

EK



DO630R

DO632R

KERPEL

DO630R-DO632R

145 mm, 5 3/4"



DO631R

DO633R

KERPEL

DO631R-DO633R

145 mm, 5 3/4"

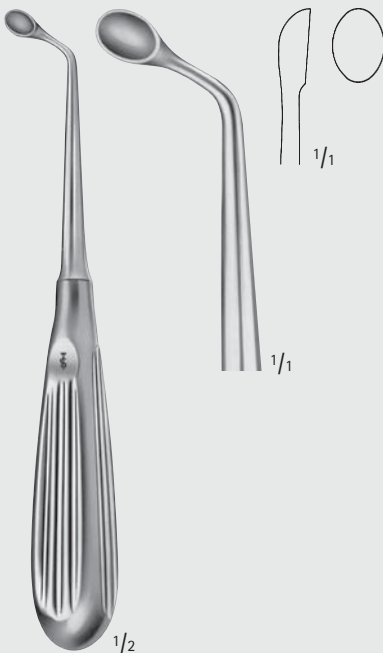

UFFENDORDE

FK660R

170 mm, 6 3/4"

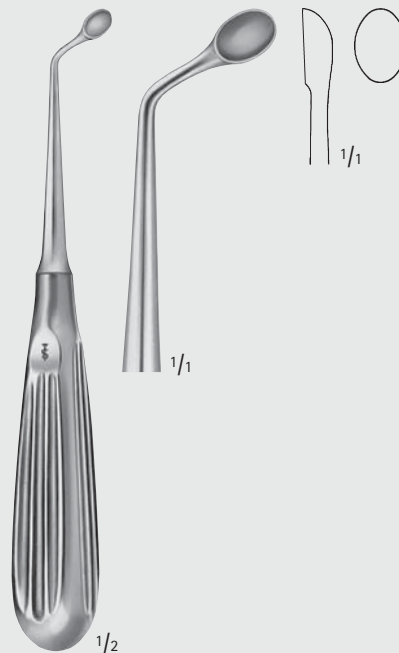

UFFENDORDE

FK661R

170 mm, 6 3/4"

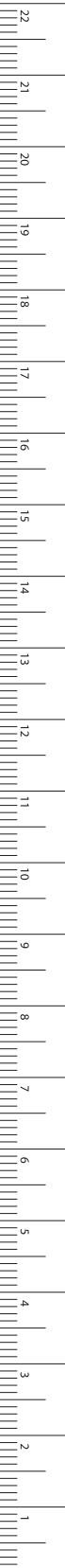

MILLIMETERS

Knochenheber, Raspatorien, Scharfe Löffel – Bone Levers, Elevators, Bone Curettes

Scharfe Löffel Bone Curettes

FK

3 mm 4 mm 5 mm 6 mm

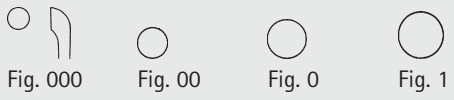

FK611R **FK612R** **FK613R** **FK614R**

8 mm 10 mm 12 mm

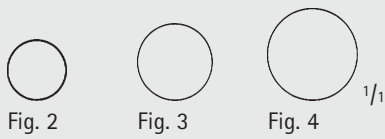

FK615R **FK616R** **FK617R**



1/2

BRUNS

FK611R-FK617R

165 mm, 6 1/2"

2,5 mm 3,4 mm 4,2 mm



FK621R **FK622R** **FK623R**

5,2 mm 6,3 mm 7,4 mm 8 mm

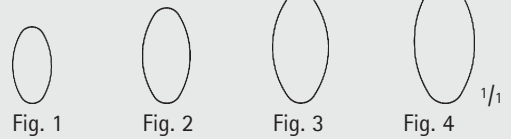

FK624R **FK625R** **FK626R** **FK627R**



SCHEDE

FK621R-FK627R

170 mm, 6 3/4"

2,8 mm 3,6 mm 4,4 mm 5,2 mm 6,8 mm



FK630R **FK631R** **FK632R** **FK633R** **FK634R**

8,5 mm 10 mm 11,5 mm 13 mm 14,5 mm

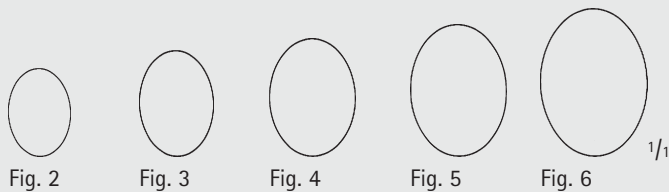

FK635R **FK636R** **FK637R** **FK638R** **FK639R**



1/2

VOLKMANN

FK630R-FK639R

170 mm, 6 3/4"

3,4 mm 5,2 mm

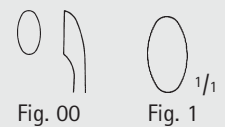

FK658R **FK659R**



1/2

WILLIGER

FK658R-FK659R

170 mm, 6 3/4"

INCHES



Knochenheber, Raspatorien, Scharfe Löffel – Bone Levers, Elevators, Bone Currettes

Scharfe Löffel
Bone Currettes

FK

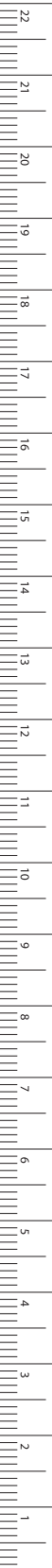

MILLIMETERS



1,8 mm

FK675R

2,0 mm

FK676R

2,4 mm

FK677R

2,6 mm

FK678R

2,8 mm

FK679R

LEMPERT

FK675R-FK679R

215 mm, 8 1/2"

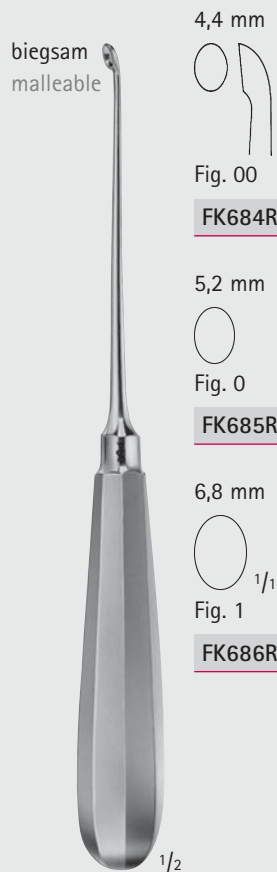

biegsam
malleable

4,4 mm

Fig. 00

FK684R

5,2 mm

Fig. 0

FK685R

6,8 mm

Fig. 1

FK686R

HALLE

FK684R-FK686R

215 mm, 8 1/2"



2,8 mm

Fig. 0000

FK662R

3,6 mm

Fig. 000

FK663R

4,4 mm

Fig. 00

FK664R

5,2 mm

Fig. 0

FK665R

DAUBENSPECK

FK662R-FK665R

200 mm, 8"

Knochenheber, Raspatorien, Scharfe Löffel – Bone Levers, Elevators, Bone Curettes

Scharfe Löffel
Bone Curettes

FK

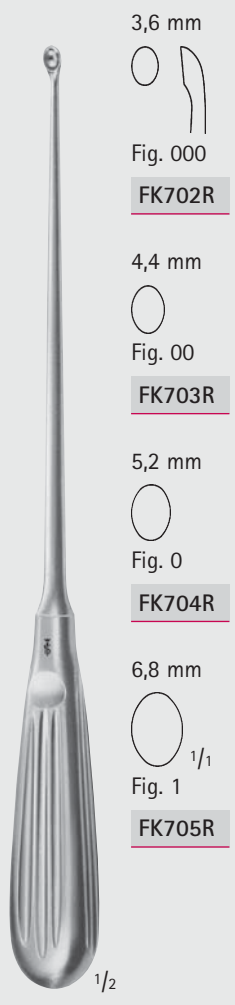

3,6 mm
Fig. 000
FK702R

4,4 mm
Fig. 00
FK703R

5,2 mm
Fig. 0
FK704R

6,8 mm
Fig. 1
FK705R

FK702R-FK705R
250 mm, 10"



3,6 mm
Fig. 000
FK712R

4,4 mm
Fig. 00
FK713R

5,2 mm
Fig. 0
FK714R

6,8 mm
Fig. 1
FK715R

FK712R-FK715R
250 mm, 10"



3 mm
FK723R

4 mm
FK724R

5 mm
FK725R

BUSHE
FK723R-FK725R
250 mm, 10"



Knochenheber, Raspatorien, Scharfe Löffel – Bone Levers, Elevators, Bone Curettes

Scharfe Löffel
Bone Curettes

EK

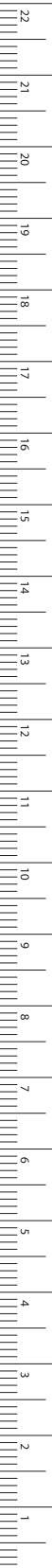

2,0 mm



Fig. 000

MB872R

2,5 mm



Fig. 00

MB873R

3,3 mm



Fig. 0

MB874R

3,8 mm



Fig. 1

MB875R

4,8 mm



Fig. 2

MB876R

5,3 mm



Fig. 3

MB877R

6,0 mm



Fig. 4

MB878R

6,7 mm



Fig. 5

MB879R

7,3 mm



Fig. 6

MB880R

$\frac{1}{2}$

BRUNS

MB872R-MB880R

230 mm, 9"

MILLIMETERS

Knochenheber, Raspatorien, Scharfe Löffel – Bone Levers, Elevators, Bone Currettes

Scharfe Löffel Bone Currettes

FK

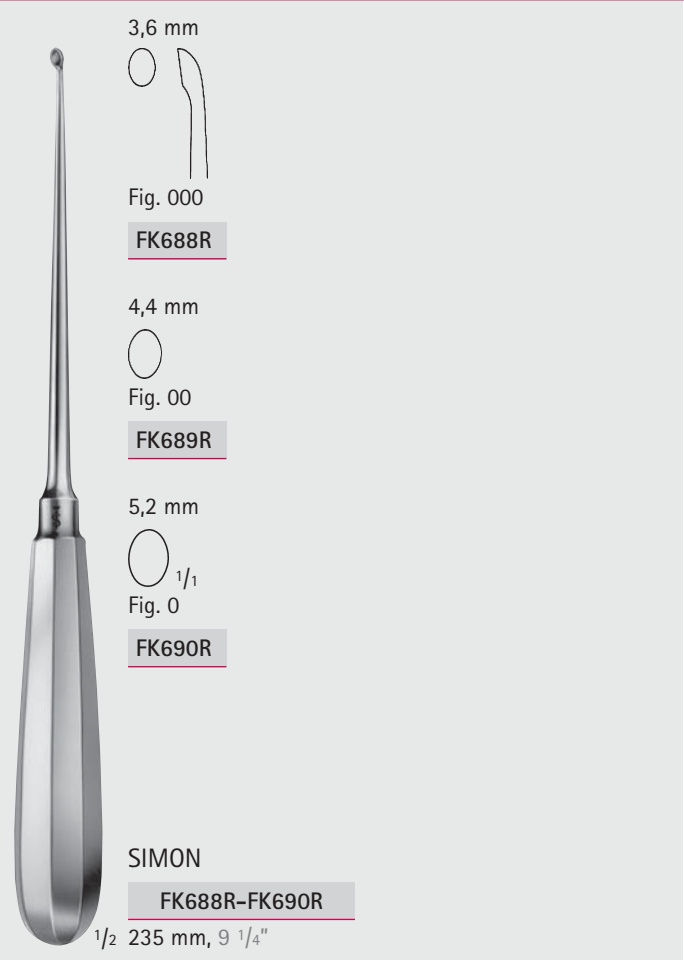



3,6 mm
Fig. 000
FK688R

4,4 mm
Fig. 00
FK689R

5,2 mm
Fig. 0
FK690R

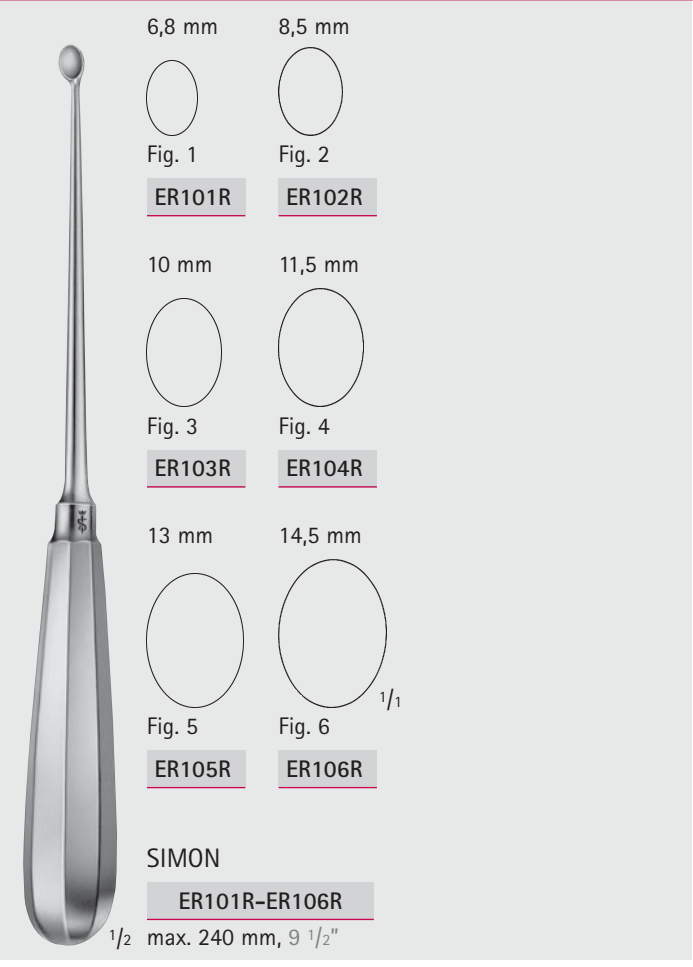
SIMON
FK688R-FK690R
1/2 235 mm, 9 1/4"



6,8 mm
Fig. 1
ER101R

8,5 mm
Fig. 2
ER102R

10 mm
Fig. 3
ER103R

11,5 mm
Fig. 4
ER104R

13 mm
Fig. 5
ER105R

14,5 mm
Fig. 6
ER106R

SIMON
ER101R-ER106R
1/2 max. 240 mm, 9 1/2"



3,6 mm
Fig. 000
FK773R

4,4 mm
Fig. 00
FK774R

5,2 mm
Fig. 0
FK775R

CASPAR
FK773R-FK775R
220 mm, 8 3/4"
1/2

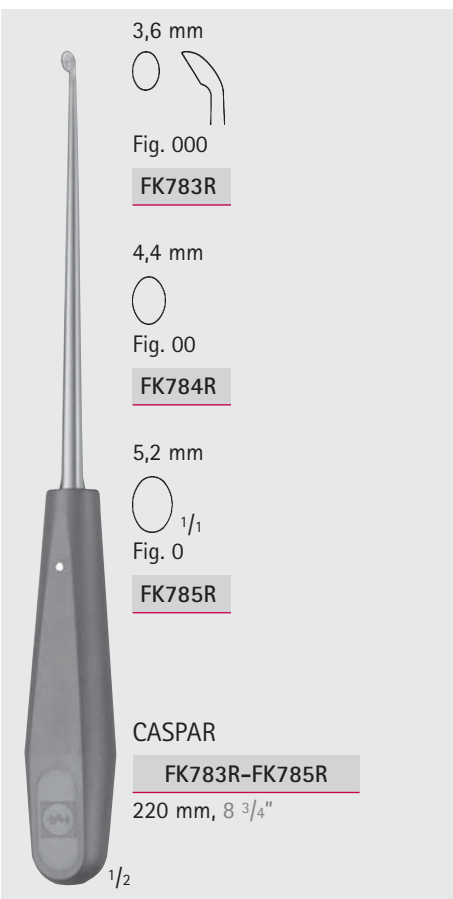

3,6 mm
Fig. 000
FK783R

4,4 mm
Fig. 00
FK784R

5,2 mm
Fig. 0
FK785R

CASPAR
FK783R-FK785R
220 mm, 8 3/4"
1/2

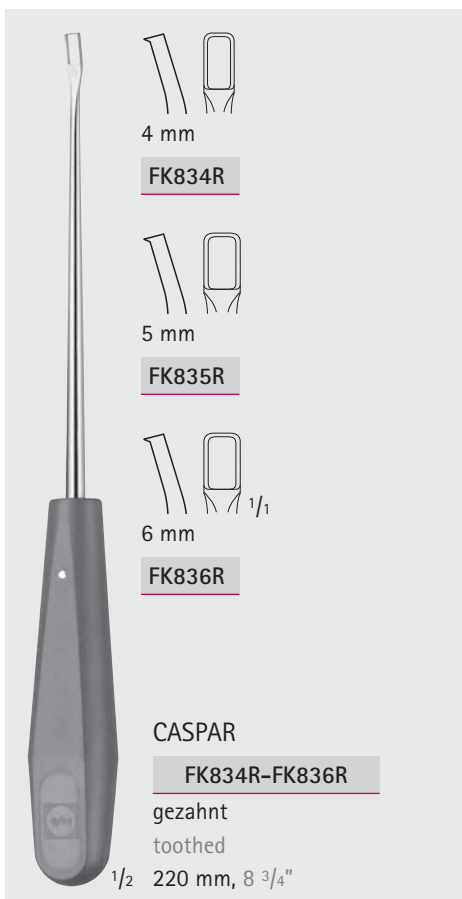

4 mm
FK834R

5 mm
FK835R

6 mm
FK836R

CASPAR
FK834R-FK836R
gezahnt
toothed
220 mm, 8 3/4"
1/2



Knochenheber, Raspatorien, Scharfe Löffel – Bone Levers, Elevators, Bone Currettes
 Scharfe Löffel
 Bone Currettes

Dampfsterilisierbar bis 143°C (3 bar)
 Can be sterilized in a steam sterilizer up to 143°C (3 bar overpressure)

EK

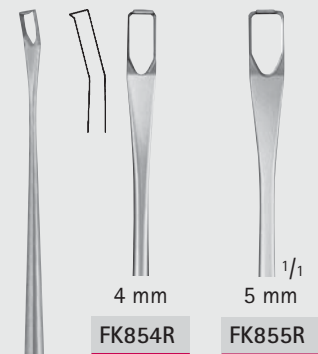

4 mm
FK854R

5 mm
FK855R

1/2

CASPAR

FK854R-FK855R

gezahnt
 toothed
 250 mm, 10"

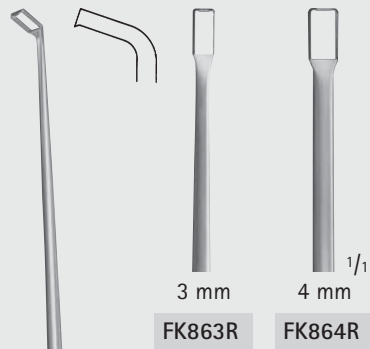

3 mm
FK863R

4 mm
FK864R

1/2

CASPAR

FK863R-FK864R

gezahnt
 toothed
 270 mm, 10 3/4"



4,4 mm
 Fig. 00
FK666R

6,8 mm
 Fig. 1
FK668R

8,5 mm
 Fig. 2
FK670R

10 mm
 Fig. 3
FK672R

1/2

FK666R-FK672R

270 mm, 10 3/4"



MILLIMETERS

Neurosurgery

Micro Dissectors/Rasps/Hooks



FD335R

$\frac{1}{2}$ Micro Scoop



FD335R

Catalog Number	Tip	Length (in.)
FD335R	STR, SHARP	9



FD336R

$\frac{1}{2}$ Micro Scoop



FD336R

Catalog Number	Tip	Length (in.)
FD336R	ANG, SHARP	9



NEURO SURGERY

INCHES

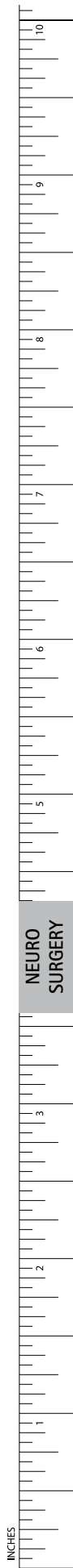

FF611R-FF614R 1/2

FF611R 1/1

FF611R 1/1

FF614R 1/1

RAY Curette

Catalog Number	Tip	Diameter (mm)	Length (in.)
FF611R	HORIZONTAL 45°	4.0	7
FF614R	VERTICAL 45°	4.0	7

140 mm, 5 1/2"

FF616R-FF618R 1/2

FF616R 1/1

FF617R 1/1

FF618R 1/1

NICOLA Curette, Malleable, Bayonet-Shaped

Catalog Number	Tip	Diameter (mm)	Working Length (in.)	Length (in.)
FF616R	CUT-RIGHT	6.5	5 1/2	10 1/4
FF617R	CUT-LEFT	6.5	5 1/2	10 1/4
FF618R	-	6.5	5 1/2	10 1/4

140 mm, 5 1/2"

FF631R-FF632R 1/2

FF631R 1/1

FF632R 1/1

FF631R 1/1

FF632R 1/1

HARDY Curette, Malleable, Bayonet-Shaped

Catalog Number	Diameter (mm)	Working Length (in.)	Length (in.)
FF631R	4.0	5 1/2	10 1/4
FF632R	6.0	5 1/2	10 1/4

Neurosurgery

Pituitary Instruments

LANDOLT Spatula, Bayonet-Shaped

Catalog Number	Shaft	Working Length (in.)	Length (in.)
FF627R	MALLEABLE	6 1/8	10 1/4

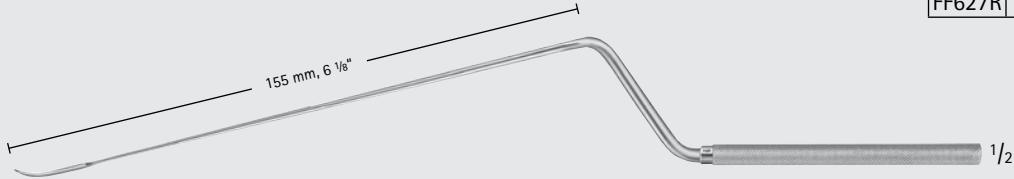

FF627R



FF627R

LANDOLT Spoon, Bayonet-Shaped

Catalog Number	Shaft	Working Length (in.)	Length (in.)
FF628R	MALLEABLE	6 1/8	10 1/4

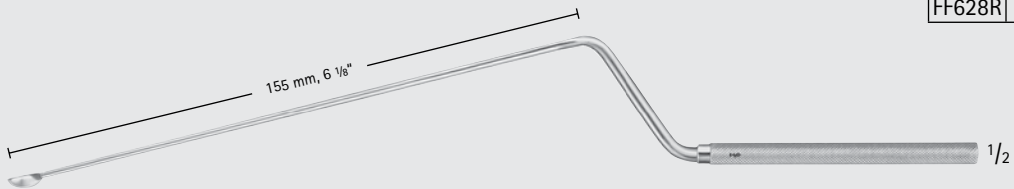

FF628R



FF628R

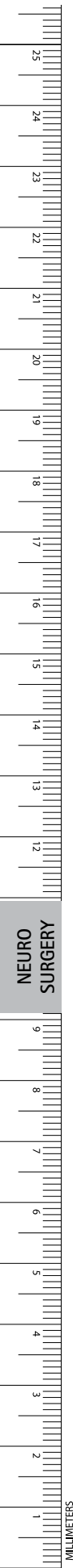

NEURO SURGERY

MILLIMETERS

LANDOLT-REULEN Dissector, Bayonet-Shaped

Catalog Number	Diameter (mm)	Shaft	Working Length (in.)	Length (in.)
FF644R	2.0	RIGID	6 1/8	10 1/4

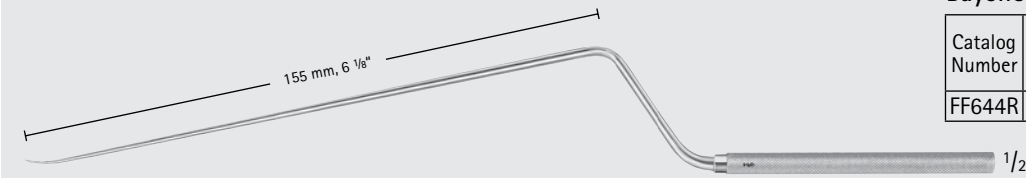

FF644R

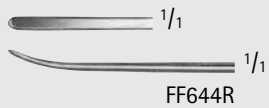

FAHLBUSCH Spoon, Bayonet-Shaped

Catalog Number	Diameter (mm)	Shaft	Working Length (in.)	Length (in.)
FF635R	2.0	MALLEABLE	6 1/8	10 1/4

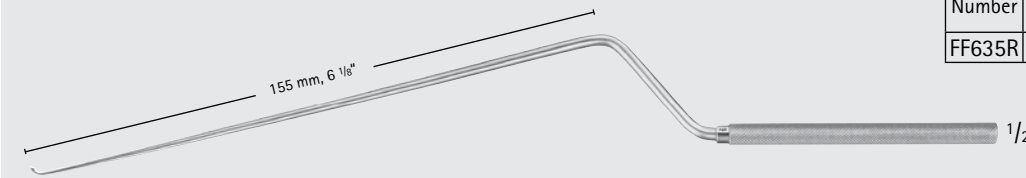

FF635R

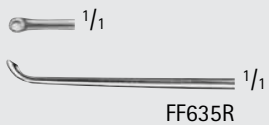

FAHLBUSCH Curette, Bayonet-Shaped

Catalog Number	Diameter (mm)	Shaft	Working Length (in.)	Length (in.)
FF637R	2.5	MALLEABLE	6 1/8	10 1/4

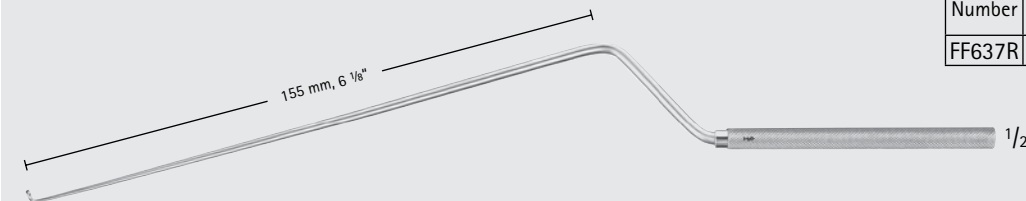

FF637R

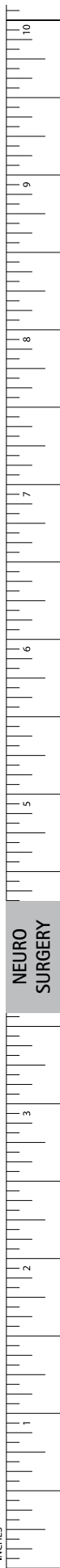
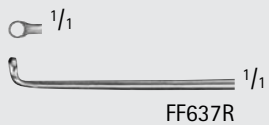

Neurosurgery

Pituitary Instruments

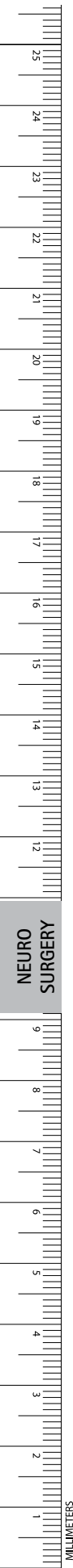

LANDOLT-REULEN Raspatory, Bayonet-Shaped

Catalog Number	Diameter (mm)	Shaft	Working Length (in.)	Length (in.)
FF640R	2.2	RIGID	6 1/8	10 1/4
FF641R	3.2	RIGID	6 1/8	10 1/4

155 mm, 6 1/8"

1/2

FF640R-FF641R

1/1
FF640R

1/1
FF641R

LANDOLT-REULEN Curette, Bayonet-Shaped

Catalog Number	Diameter (mm)	Shaft	Working Length (in.)	Length (in.)
FF642R	2.5	RIGID	6 1/8	10 1/4

155 mm, 6 1/8"

1/2

FF642R

1/1

1/1
FF642R

LANDOLT-REULEN Hook, Blunt, Bayonet-Shaped

Catalog Number	Tip Size (mm)	Shaft	Working Length (in.)	Length (in.)
FF643R	1.7	RIGID	6 1/8	10 1/4

155 mm, 6 1/8"

1/2

FF643R

1/1
FF643R

NEURO SURGERY

MILLIMETERS

Orthopedics/Spine

Microdiscectomy Instruments

Microdiscectomy Cervical Instruments

Catalog Number	Tip Size (#)	Tip	Length (in.)
MF250	COMPLETE SET (Includes One Each of All Items Listed)		
MF251R	0	FWD STR	8 1/2
MF252R	00	FWD STR	8 1/2
MF253R	000	FWD STR	8 1/2
MF254R	0000	FWD STR	8 1/2
MF255R	Bone Cutter	FWD STR	8 1/2
MF256R	0	FWD ANG	8 1/2
MF257R	00	FWD ANG	8 1/2
MF258R	000	FWD ANG	8 1/2
MF259R	0000	FWD ANG	8 1/2
MF260R	Bone Cutter	FWD ANG	8 1/2
MF261R	0	BACK STR	8 1/2
MF262R	00	BACK STR	8 1/2
MF263R	000	BACK STR	8 1/2
MF264R	0000	BACK STR	8 1/2
MF265R	Bone Cutter	BACK STR	8 1/2
MF266R	0	BACK ANG	8 1/2
MF267R	00	BACK ANG	8 1/2
MF268R	000	BACK ANG	8 1/2
MF269R	0000	BACK ANG	8 1/2
MF270R	Bone Cutter	BACK ANG	8 1/2
MF321R		MICRO NERVE HOOK	8 1/2
MF322R		ULTRA MICRO NERVE HOOK	8 1/2
MF323R		BONE WAXER	8 1/2
MF320	Case - 12 Instruments (Set includes 2 cases)		

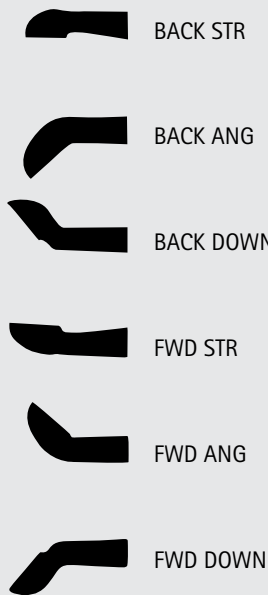

Microdiscectomy Cervical Long Instruments

Catalog Number	Tip Size (#)	Tip	Length (in.)
MF271	COMPLETE SET (Includes One Each of All Items Listed)		
MF272R	0	FWD STR	9 1/2
MF273R	00	FWD STR	9 1/2
MF274R	000	FWD STR	9 1/2
MF275R	0000	FWD STR	9 1/2
MF276R	Bone Cutter	FWD STR	9 1/2
MF277R	0	FWD ANG	9 1/2
MF278R	00	FWD ANG	9 1/2
MF279R	000	FWD ANG	9 1/2
MF280R	0000	FWD ANG	9 1/2
MF281R	Bone Cutter	FWD ANG	9 1/2
MF282R	0	BACK STR	9 1/2
MF283R	00	BACK STR	9 1/2
MF284R	000	BACK STR	9 1/2
MF285R	0000	BACK STR	9 1/2
MF286R	Bone Cutter	BACK STR	9 1/2
MF287R	0	BACK ANG	9 1/2
MF288R	00	BACK ANG	9 1/2
MF289R	000	BACK ANG	9 1/2
MF290R	0000	BACK ANG	9 1/2
MF291R	Bone Cutter	BACK ANG	9 1/2
MF292R		NERVE HOOK	9 1/2
MF293R		ULTRA MICRO NERVE HOOK	9 1/2
MF294R			9 1/2
MF320	Case - 12 Instruments (Set includes 2 cases)		

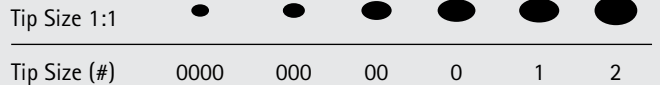

Microdiscectomy Lumbar Instruments

Catalog Number	Tip Size (#)	Tip	Length (in.)
MF295	COMPLETE SET (Includes One Each of All Items Listed)		
MF296R	0	FWD STR	9 1/2
MF297R	1	FWD STR	9 1/2
MF298R	2	FWD STR	9 1/2
MF299R	0	FWD ANG	9 1/2
MF300R	1	FWD ANG	9 1/2
MF301R	2	FWD ANG	9 1/2
MF302R	0	FWD DOWN	9 1/2
MF303R	1	FWD DOWN	9 1/2
MF304R	2	FWD DOWN	9 1/2
MF305R	0	BACK STR	9 1/2
MF306R	1	BACK STR	9 1/2
MF307R	2	BACK STR	9 1/2
MF308R	0	BACK ANG	9 1/2
MF309R	1	BACK ANG	9 1/2
MF310R	2	BACK ANG	9 1/2
MF311R	0	BACK DOWN	9 1/2
MF312R	1	BACK DOWN	9 1/2
MF313R	2	BACK DOWN	9 1/2
MF314R		#1 PENFIELD	9 1/2
MF315R		#2 PENFIELD	9 1/2
MF316R		NERVE HOOK	9 1/2
MF317R		#4 PENFIELD	9 1/2
MF318R		BONE WAXER	9 1/2
MF319R		SPINE PROBE	9 1/2
MF320	Case - 12 Instruments (Set includes 2 cases)		

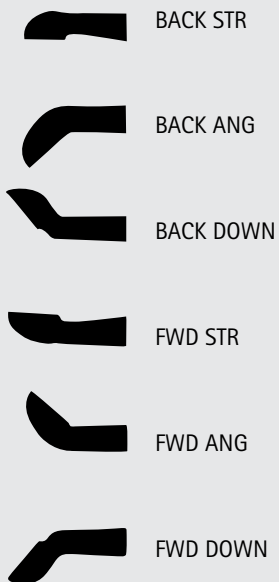

Tip Size 1:1

Tip Size (#)

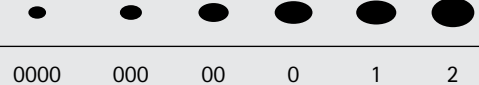



FK653R

Bone Curette, slightly curved, 190 mm (7 1/2"), width: 3 mm, non-sterile, reusable



Product search type	Bone Curette
Aesculap Product	
Groups	General Surgical Instruments
Geometry	slightly curved
Length	190.00 mm
Length (Inch)	7 1/2
Width (mm)	3.000 mm
Data Matrix	Yes
Product contains Latex	No
Sterility	non-sterile
Disposable / Reusable	reusable



FK654R

Bone Curette, strongly curved, 190 mm (7 1/2"), width: 3 mm, non-sterile, reusable



Product search type	Bone Curette
Aesculap Product	
Groups	General Surgical Instruments
Geometry	strongly curved
Length	190.00 mm
Length (Inch)	7 1/2
Width (mm)	3.000 mm
Data Matrix	Yes
Product contains Latex	No
Sterility	non-sterile
Disposable / Reusable	reusable



FK650R

Bone Curette, curved, 190 mm (7 1/2"), oval, #2, non-sterile, reusable



Product search type	Bone Curette
Aesculap Product	
Groups	General Surgical Instruments
Geometry	curved
Shape / Form	oval
Length	190.00 mm
Length (Inch)	7 1/2
Figure / Size	#2
Data Matrix	Yes
Product contains Latex	No
Sterility	non-sterile
Disposable / Reusable	reusable





FK651R

Bone Curette, angled, 190 mm (7 1/2"), oval, width: 4 mm, non-sterile, reusable



Product search type	Bone Curette
Aesculap Product	
Groups	General Surgical Instruments
Geometry	angled
Shape / Form	oval
Length	190.00 mm
Length (Inch)	7 1/2
Width (mm)	4.000 mm
Data Matrix	Yes
Product contains Latex	No
Sterility	non-sterile
Disposable / Reusable	reusable



FK652R

Bone Curette, angled, 190 mm (7 1/2"), width: 3 mm, non-sterile, reusable

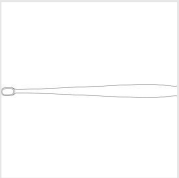

Product search type	Bone Curette
Aesculap Product	
Groups	General Surgical Instruments
Geometry	angled
Length	190.00 mm
Length (Inch)	7 1/2
Width (mm)	3.000 mm
Data Matrix	Yes
Product contains Latex	No
Sterility	non-sterile
Disposable / Reusable	reusable

По вопросам продаж и поддержки обращайтесь:

Алматы (7273)495-231	Казань (843)206-01-48	Новокузнецк (3843)20-46-81	Смоленск (4812)29-41-54
Архангельск (8182)63-90-72	Калининград (4012)72-03-81	Новосибирск (383)227-86-73	Сочи (862)225-72-31
Астрахань (8512)99-46-04	Калуга (4842)92-23-67	Омск (3812)21-46-40	Ставрополь (8652)20-65-13
Барнаул (3852)73-04-60	Кемерово (3842)65-04-62	Орел (4862)44-53-42	Сургут (3462)77-98-35
Белгород (4722)40-23-64	Киров (8332)68-02-04	Оренбург (3532)37-68-04	Тверь (4822)63-31-35
Брянск (4832)59-03-52	Краснодар (861)203-40-90	Пенза (8412)22-31-16	Томск (3822)98-41-53
Владивосток (423)249-28-31	Красноярск (391)204-63-61	Пермь (342)205-81-47	Тула (4872)74-02-29
Волгоград (844)278-03-48	Курск (4712)77-13-04	Ростов-на-Дону (863)308-18-15	Тюмень (3452)66-21-18
Вологда (8172)26-41-59	Липецк (4742)52-20-81	Рязань (4912)46-61-64	Ульяновск (8422)24-23-59
Воронеж (473)204-51-73	Магнитогорск (3519)55-03-13	Самара (846)206-03-16	Уфа (347)229-48-12
Екатеринбург (343)384-55-89	Москва (495)268-04-70	Санкт-Петербург (812)309-46-40	Хабаровск (4212)92-98-04
Иваново (4932)77-34-06	Мурманск (8152)59-64-93	Саратов (845)249-38-78	Челябинск (351)202-03-61
Ижевск (3412)26-03-58	Набережные Челны (8552)20-53-41	Севастополь (8692)22-31-93	Череповец (8202)49-02-64
Иркутск (395)279-98-46	Нижний Новгород (831)429-08-12	Симферополь (3652)67-13-56	Ярославль (4852)69-52-93
Россия (495)268-04-70	Киргизия (996)312-96-26-47	Казахстан (7172)727-132	