

# MÜNSTER

## Технические характеристики

### По вопросам продаж и поддержки обращайтесь:

Алматы (7273)495-231	Казань (843)206-01-48	Новокузнецк (3843)20-46-81	Смоленск (4812)29-41-54
Архангельск (8182)63-90-72	Калининград (4012)72-03-81	Новосибирск (383)227-86-73	Сочи (862)225-72-31
Астрахань (8512)99-46-04	Калуга (4842)92-23-67	Омск (3812)21-46-40	Ставрополь (8652)20-65-13
Барнаул (3852)73-04-60	Кемерово (3842)65-04-62	Орел (4862)44-53-42	Сургут (3462)77-98-35
Белгород (4722)40-23-64	Киров (8332)68-02-04	Оренбург (3532)37-68-04	Тверь (4822)63-31-35
Брянск (4832)59-03-52	Краснодар (861)203-40-90	Пенза (8412)22-31-16	Томск (3822)98-41-53
Владивосток (423)249-28-31	Красноярск (391)204-63-61	Пермь (342)205-81-47	Тула (4872)74-02-29
Волгоград (844)278-03-48	Курск (4712)77-13-04	Ростов-на-Дону (863)308-18-15	Тюмень (3452)66-21-18
Вологда (8172)26-41-59	Липецк (4742)52-20-81	Рязань (4912)46-61-64	Ульяновск (8422)24-23-59
Воронеж (473)204-51-73	Магнитогорск (3519)55-03-13	Самара (846)206-03-16	Уфа (347)229-48-12
Екатеринбург (343)384-55-89	Москва (495)268-04-70	Санкт-Петербург (812)309-46-40	Хабаровск (4212)92-98-04
Иваново (4932)77-34-06	Мурманск (8152)59-64-93	Саратов (845)249-38-78	Челябинск (351)202-03-61
Ижевск (3412)26-03-58	Набережные Челны (8552)20-53-41	Севастополь (8692)22-31-93	Череповец (8202)49-02-64
Иркутск (395)279-98-46	Нижний Новгород (831)429-08-12	Симферополь (3652)67-13-56	Ярославль (4852)69-52-93
Россия (495)268-04-70	Киргизия (996)312-96-26-47	Казахстан (7172)727-132	

# MÜNSTER Retraction System

## Elements of the closed frame system

Frame

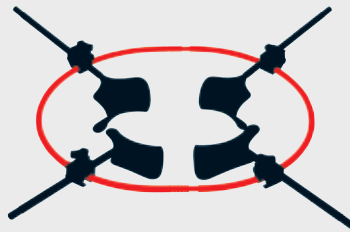

Frame extension

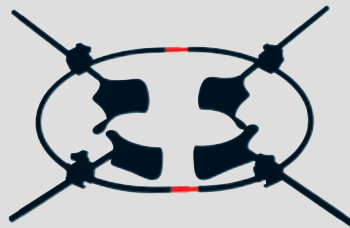

Clamps

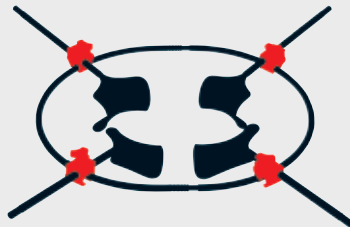

Rods

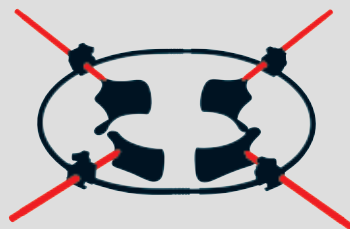

Retractor blades

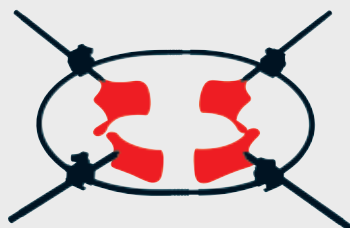

## Elements of the open frame system

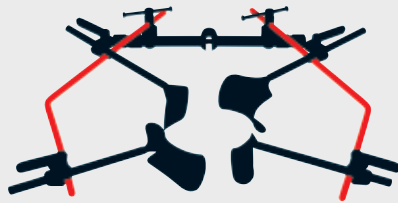

Frame

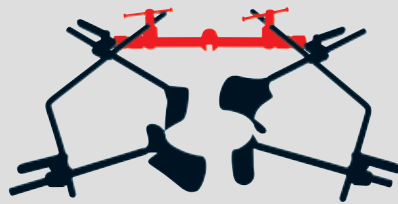

Frame holder

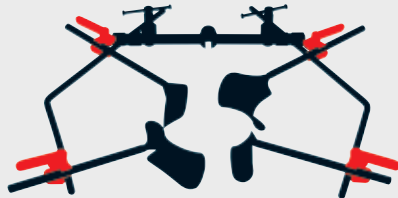

Clamps

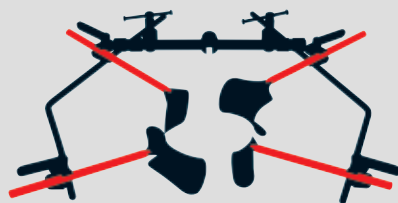

Rods

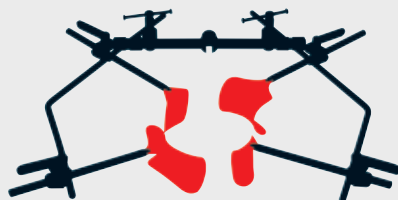

Retractor blades

# MÜNSTER Retraction System

## Frame, round

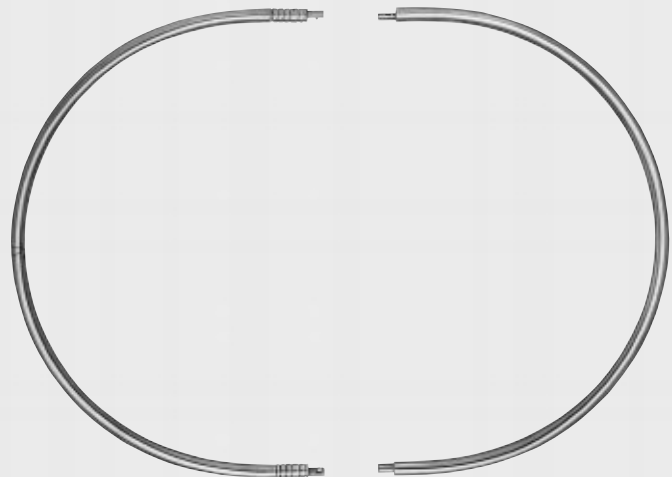
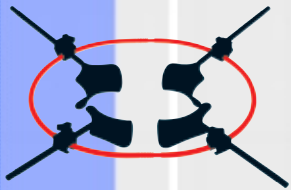

- BV814R Abdominal frame I, detachable, 238 x 180 mm
- BV815R Abdominal frame II, detachable, 238 x 270 mm
- BV817R Abdominal frame III, detachable, 408 x 350 mm

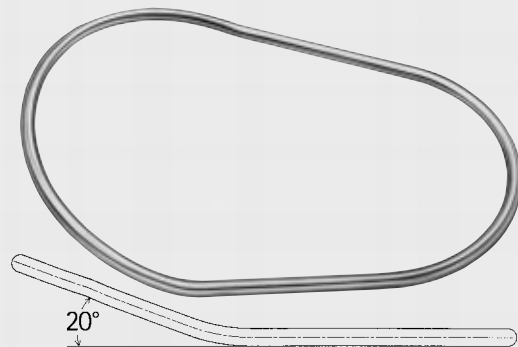

- BV816R Vaginal frame, 20° angled, 270 x 200 mm, not detachable

## Frame extensions



- BV819R Frame extension rod, 100 mm (1 Pair)



- BV821R Frame extension rod, 250 mm (1 Pair)



- BV820R Frame extension rod, curved, 250 mm (1 Pair)





## Frame, open

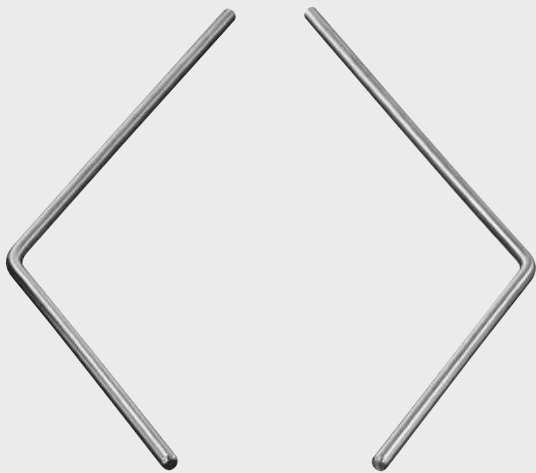

BV845R V-shaped sickle frame (1 Pair)

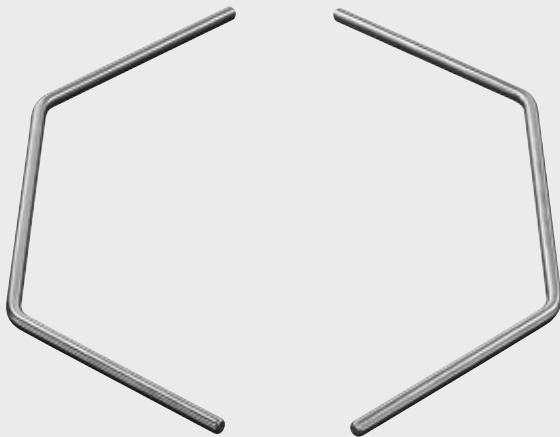

BV846R U-shaped sickle frame (1 Pair)

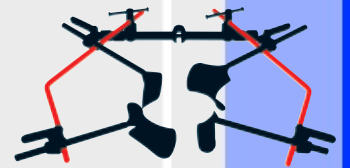

## Frame holder



BV844R Frame holder

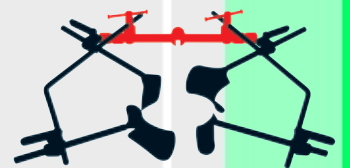

# MÜNSTER Retraction System

## Clamps

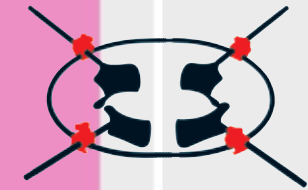

BV822R Connecting clamp  
for notch rods

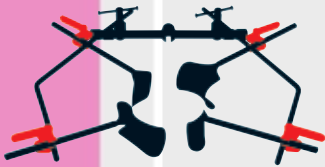

BV838R Connecting clamp, with latching  
mechanism for octangular notch rods



BV837R Connecting clamp, rotatable,  
**without** ratchet mechanism



## Rods

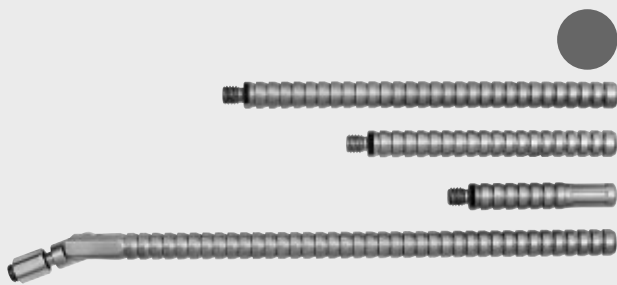

### Round notch rods

- BV825R 150 mm
- BV826R Extension notch rod, 100 mm
- BV827R End part, 60 mm
- BV834R with joint, 200 mm

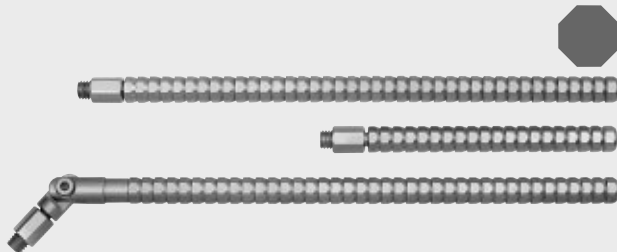
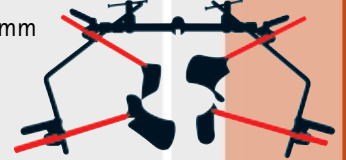
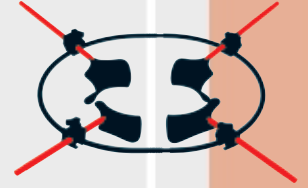

### Octangular notch rods

- BV840R 220 mm
- BV839R 120 mm
- BV833R with joint and locking screw, 220 mm

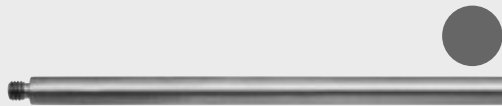

- BV828R Rod, **round**, smooth, 200 mm



- BV835R Adapter for retractor blades with ball snap closure (KSV)



- FG 290R Wrench for fixation of the retractor blades on the rods BV840R, BV839R, BV833R and BV834R

# MÜNSTER Retraction System

## Clamps - Rods - Combination possibilities

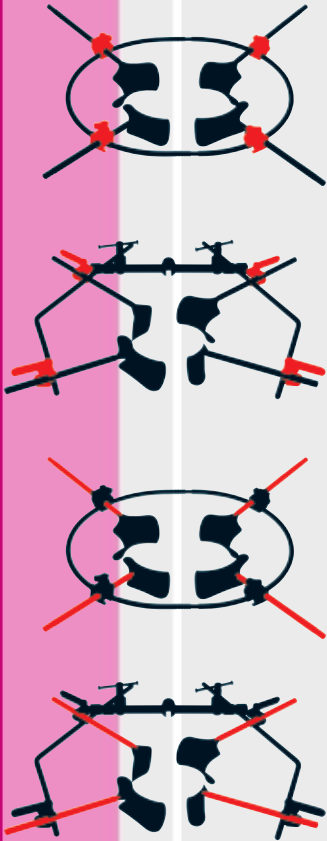

Clamps  
BV822R

BV838R

BV837R



Round notch rods  
BV825R, BV826R, BV834R



Octagonal notch rods  
BV839R, BV840R, BV833R



= optimal combination

= limited function

= not adaptable

The combination of the connecting clamp BV838R with the octagonal locking rods BV839R and BV840R permits locking of the retractors and prevents rotation.

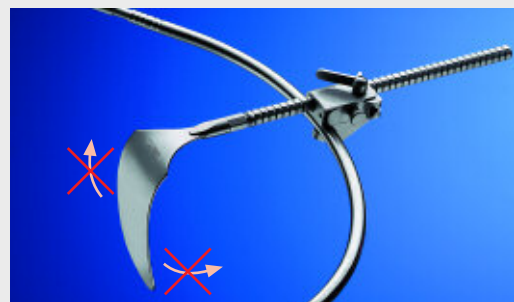





## Retractor blades

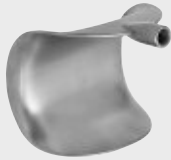

BV961R Abdominal retractor blade, size I, 62 x 67 mm

BV962R Abdominal retractor blade, size II, 80 x 80 mm

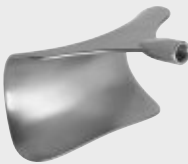

BV945R Abdominal retractor blade, 50 x 90 mm

BV946R Abdominal retractor blade, 50 x 105 mm

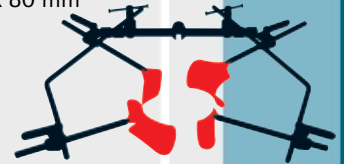

BV947R Retractor blade KELLY, 63 x 50 mm

BV948R Retractor blade KELLY, 70 x 63 mm



BV972R Abdominal retractor blade, 100 x 100 mm

BV973R Abdominal retractor blade, 100 x 120 mm

# MÜNSTER Retraction System

## Retractor blades with ball snap closure (KSV)

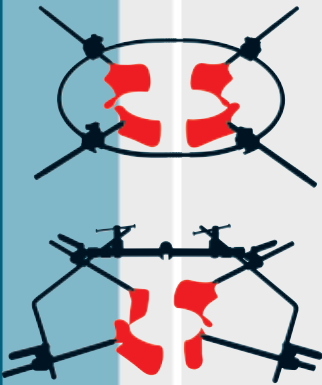

- BV555R Retractor blades (Pair), 48 x 59 mm, KSV
- BV556R Retractor blades (Pair), 58 x 80 mm, KSV
- BV557R Retractor blades (Pair), 72 x 84 mm, KSV

- BV551R Retractor blades (Pair), 37 x 62 mm, KSV
- BV552R Retractor blades (Pair), 37 x 80 mm, KSV
- BV553R Retractor blades (Pair), 37 x 98 mm, KSV

- BV558R Retractor blades (Pair), 59 x 80 mm, KSV

- BV570R Thorax retractor blade, 68 x 56 mm

- BV959R Y-Bladder spatula, 170 x 73 mm, KSV

- BV835R Adapter for ball snap closure blade, see page 9



## Retractor blades



BV950R Retractor blade MIKULICZ, 120 x 50 mm  
BV951R Retractor blade MIKULICZ, 155 x 50 mm



BV952R Liver retractor, 140 x 85 mm

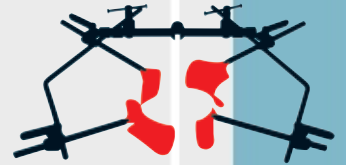

BV953R Bladder spatula, 115 x 85 mm,  
30° angled



BT625R Liver retractor, 125 x 140 mm

# MÜNSTER Retraction System

## Retractor blades

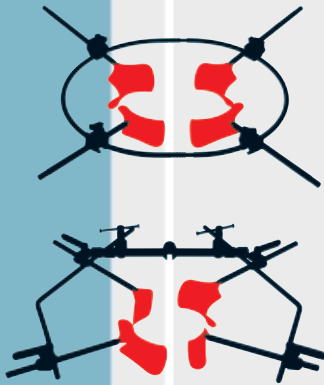

BV949R Retractor blade KELLY, 150 x 39 mm

BV965R Retractor blade KELLY, 220 x 40 mm

BV966R Retractor blade KELLY, 220 x 70 mm

BV967R Retractor blade KELLY, 220 x 70 mm

BV964R Vaginal retractor posterior blade, 115 x 25 mm

BV968R Retractor blade, 220 x 25 mm



## Retractor blades



BV954R Abdominal spatula, malleable,  
220 x 30 mm

BV955R Abdominal spatula, malleable,  
220 x 40 mm

BV956R Abdominal spatula, malleable,  
220 x 50 mm

BV957R Abdominal spatula, malleable,  
220 x 85 mm



BV960R Retractor blade DEEVER,  
85 x 25 mm, Fig. 2<sup>1</sup>/<sub>2</sub>



BV963R Vagina retractor blade,  
lateral blade, 75 x 25 mm



BV958R Retractor blade HARRINGTON,  
127 x 62 mm



BV836R Handle for retractor blades,  
with screw thread

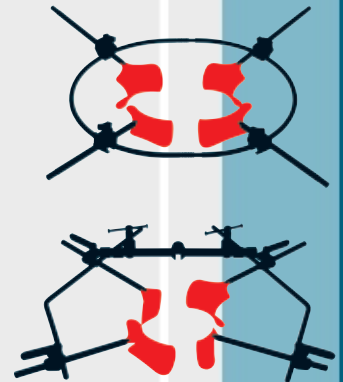

# MÜNSTER Retraction System

## OR-Table Fixation

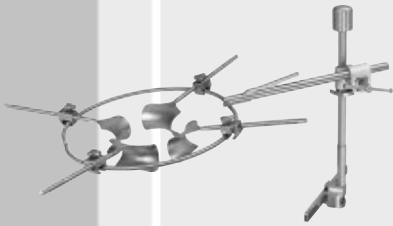

BV829R Holding arm for abdominal frame

RT092R Double fixation element for connecting  
BV829R or BV842R with RT069

RT069R Rod with adapter for assembling at  
the OR-Table with the dimensions:  
Width 9-10 mm x Height 25-35 mm



## OR-Table Fixation

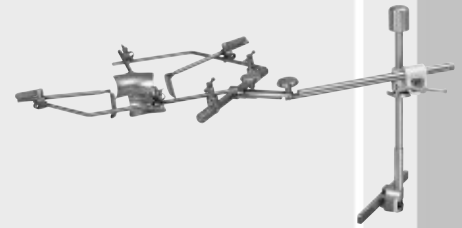

BV842R Holding arm with joint, for abdominal frame

RT092R Double fixation element for connecting BV829R or BV842R with RT069

RT069R Rod with adapter for assembling at the OR-Table with the dimensions: Width 9-10 mm x Height 25-35 mm

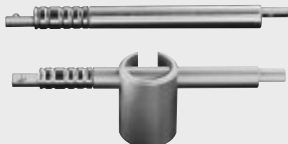

BV843R Fixation element for abdominal frames permits safe horizontal fixation of the abdominal frames.

# MÜNSTER Retraction System

## GNAUERT Frame for Upper Abdomen

BV848R GNAUERT Frame for upper abdomen,  
consisting of: 1 Frame (horizontal)  
2 Vertical rods

Additionally required (please order separately):  
2 RT090R  
Connecting clamps



BV827R Notch rod end part  
BV837R 2 Clamps  
Round notch rods (BV825R or BV826R)  
BV835R Coupling piece  
Retractor blades  
(recommended BV555R, BV557R, BV558R BV570R)

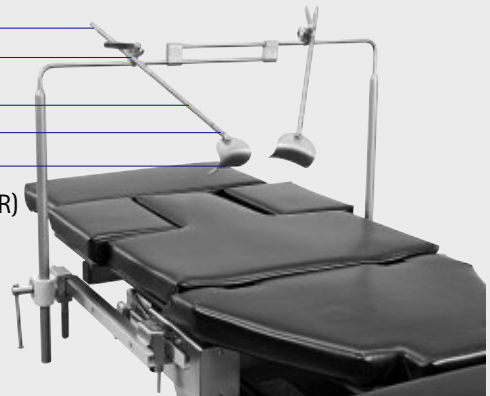

Set up example with two clamps BV837R

BV827R Notch rod end part  
BV838R Clamp  
Round notch rods (BV825R or BV826R)  
Retractor blades  
(recommended BV945R, BV946R)



Set up example with one clamp BV838R



## ROCHARD-OR-Table Fixation

## Accessories for storage

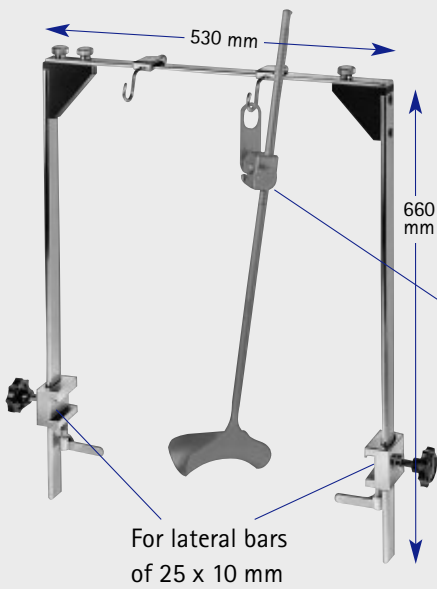

**BT708R** Mounting frame for fastening to both sides of the lateral bars of the operating table providing more stability. Easy dismantling for sterilization.

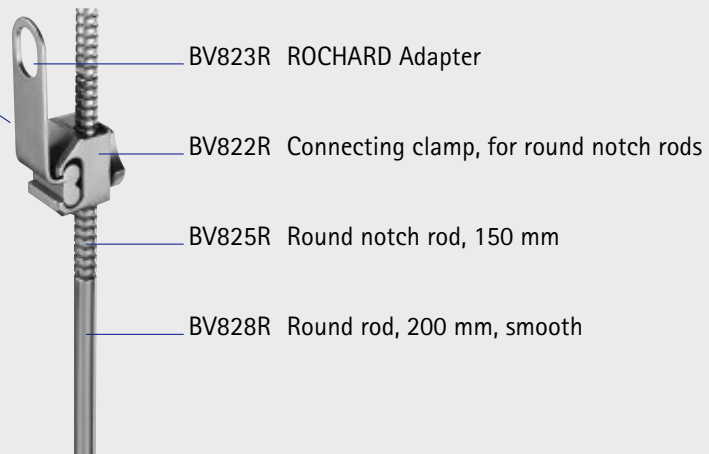

**BV823R** ROCHARD Adapter

**BV822R** Connecting clamp, for round notch rods

**BV825R** Round notch rod, 150 mm

**BV828R** Round rod, 200 mm, smooth

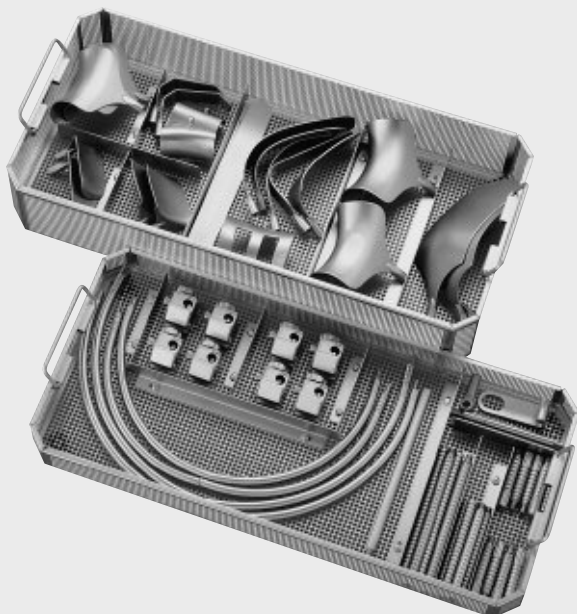

**BV831R** Wire basket, 540 x 253 x 100 mm, for storing the retractor blades

**BV832R** Wire basket, 540 x 253 x 50 mm, for storing abdominal frames, notch rods and connecting clamps

**По вопросам продаж и поддержки обращайтесь:**

Алматы (7273)495-231	Казань (843)206-01-48	Новокузнецк (3843)20-46-81	Смоленск (4812)29-41-54
Архангельск (8182)63-90-72	Калининград (4012)72-03-81	Новосибирск (383)227-86-73	Сочи (862)225-72-31
Астрахань (8512)99-46-04	Калуга (4842)92-23-67	Омск (3812)21-46-40	Ставрополь (8652)20-65-13
Барнаул (3852)73-04-60	Кемерово (3842)65-04-62	Орел (4862)44-53-42	Сургут (3462)77-98-35
Белгород (4722)40-23-64	Киров (8332)68-02-04	Оренбург (3532)37-68-04	Тверь (4822)63-31-35
Брянск (4832)59-03-52	Краснодар (861)203-40-90	Пенза (8412)22-31-16	Томск (3822)98-41-53
Владивосток (423)249-28-31	Красноярск (391)204-63-61	Пермь (342)205-81-47	Тула (4872)74-02-29
Волгоград (844)278-03-48	Курск (4712)77-13-04	Ростов-на-Дону (863)308-18-15	Тюмень (3452)66-21-18
Вологда (8172)26-41-59	Липецк (4742)52-20-81	Рязань (4912)46-61-64	Ульяновск (8422)24-23-59
Воронеж (473)204-51-73	Магнитогорск (3519)55-03-13	Самара (846)206-03-16	Уфа (347)229-48-12
Екатеринбург (343)384-55-89	Москва (495)268-04-70	Санкт-Петербург (812)309-46-40	Хабаровск (4212)92-98-04
Иваново (4932)77-34-06	Мурманск (8152)59-64-93	Саратов (845)249-38-78	Челябинск (351)202-03-61
Ижевск (3412)26-03-58	Набережные Челны (8552)20-53-41	Севастополь (8692)22-31-93	Череповец (8202)49-02-64
Иркутск (395)279-98-46	Нижний Новгород (831)429-08-12	Симферополь (3652)67-13-56	Ярославль (4852)69-52-93
Россия (495)268-04-70	Киргизия (996)312-96-26-47	Казахстан (7172)727-132	