

# Технические характеристики

## По вопросам продаж и поддержки обращайтесь:

Алматы (7273)495-231	Казань (843)206-01-48	Новокузнецк (3843)20-46-81	Смоленск (4812)29-41-54
Архангельск (8182)63-90-72	Калининград (4012)72-03-81	Новосибирск (383)227-86-73	Сочи (862)225-72-31
Астрахань (8512)99-46-04	Калуга (4842)92-23-67	Омск (3812)21-46-40	Ставрополь (8652)20-65-13
Барнаул (3852)73-04-60	Кемерово (3842)65-04-62	Орел (4862)44-53-42	Сургут (3462)77-98-35
Белгород (4722)40-23-64	Киров (8332)68-02-04	Оренбург (3532)37-68-04	Тверь (4822)63-31-35
Брянск (4832)59-03-52	Краснодар (861)203-40-90	Пенза (8412)22-31-16	Томск (3822)98-41-53
Владивосток (423)249-28-31	Красноярск (391)204-63-61	Пермь (342)205-81-47	Тула (4872)74-02-29
Волгоград (844)278-03-48	Курск (4712)77-13-04	Ростов-на-Дону (863)308-18-15	Тюмень (3452)66-21-18
Вологда (8172)26-41-59	Липецк (4742)52-20-81	Рязань (4912)46-61-64	Ульяновск (8422)24-23-59
Воронеж (473)204-51-73	Магнитогорск (3519)55-03-13	Самара (846)206-03-16	Уфа (347)229-48-12
Екатеринбург (343)384-55-89	Москва (495)268-04-70	Санкт-Петербург (812)309-46-40	Хабаровск (4212)92-98-04
Иваново (4932)77-34-06	Мурманск (8152)59-64-93	Саратов (845)249-38-78	Челябинск (351)202-03-61
Ижевск (3412)26-03-58	Набережные Челны (8552)20-53-41	Севастополь (8692)22-31-93	Череповец (8202)49-02-64
Иркутск (395)279-98-46	Нижний Новгород (831)429-08-12	Симферополь (3652)67-13-56	Ярославль (4852)69-52-93
Россия (495)268-04-70	Киргизия (996)312-96-26-47	Казахстан (7172)727-132	

# Herz- und Gefäß-Chirurgie – Cardiovascular Surgery

## Bulldogklemmen

### Bulldog Clamps

FB



#### JOHNS-HOPKINS

**BH018R**

Zange zum Anlegen und Abnehmen der Bulldogklemmen BH011R - BH031R und FB420R - FB427R

Forceps for applying and removing bulldog clamps BH011R - BH031R and FB420R - FB427R

240 mm, 9 3/4"

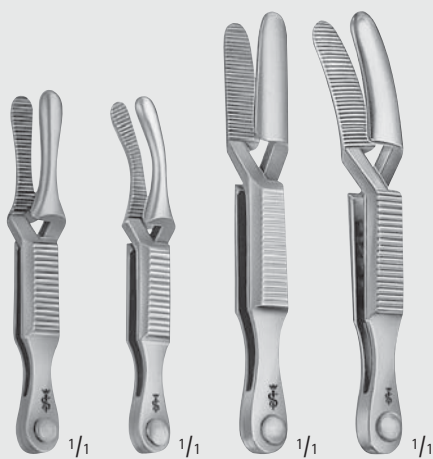

**BH020R** **BH021R** **BH026R** **BH027R**  
**BH022R** **BH023R**

#### DIEFFENBACH

Gesamtlänge: Maullänge:  
 Total length: Jaw length:

BH020R	38 mm, 1 1/2"	12 mm, 1/2"
BH022R	48 mm, 2"	16 mm, 5/8"
BH021R	38 mm, 1 1/2"	12 mm, 1/2"
BH023R	48 mm, 2"	16 mm, 5/8"
BH026R	58 mm, 2 1/8"	16 mm, 5/8"
BH027R	58 mm, 2 1/8"	16 mm, 5/8"



**BH011R-BH017R**

#### JOHNS-HOPKINS

Gesamtlänge: Maullänge:  
 Total length: Jaw length:

BH011R	38 mm, 1 1/2"	12 mm, 1/2"
BH012R	48 mm, 2"	17 mm, 5/8"
BH013R	56 mm, 2 1/8"	25 mm, 1"
BH014R	63 mm, 2 1/2"	30 mm, 1 3/16"
BH015R	70 mm, 2 3/4"	33 mm, 1 1/4"
BH016R	80 mm, 3 1/8"	42 mm, 1 3/4"
BH017R	91 mm, 3 1/2"	52 mm, 2"



# Herz- und Gefäß-Chirurgie – Cardiovascular Surgery

## Bulldogklemmen

## Bulldog Clamps

FB



1/1

DE BAKEY-HESS

**BH030R**

Gesamtlänge: 34 mm  
 Total length: 1 3/8"  
 Maullänge: 20 mm  
 Jaw length: 3/4"



**FB328R**

Gesamtlänge: 35 mm  
 Total length: 1 3/8"  
 Maullänge: 14 mm  
 Jaw length: 1/2"



**FB329R**

Gesamtlänge: 35 mm  
 Total length: 1 3/8"  
 Maullänge: 14 mm  
 Jaw length: 1/2"



**FB330R**

Gesamtlänge: 45 mm  
 Total length: 1 3/4"  
 Maullänge: 19 mm  
 Jaw length: 3/4"



1/1

**FB331R**

Gesamtlänge: 45 mm  
 Total length: 1 3/4"  
 Maullänge: 19 mm  
 Jaw length: 3/4"



1/1

DE BAKEY-HESS

**BH031R**

Gesamtlänge: 43 mm  
 Total length: 1 7/10"  
 Maullänge: 30 mm  
 Jaw length: 1 3/16"



DIETHRICH

**MB285R**

Gesamtlänge: 55 mm  
 Total length: 2 1/8"  
 Maullänge: 13 mm  
 Jaw length: 1/2"



DIETHRICH

**BH032R**

Gesamtlänge: 48 mm  
 Total length: 1 7/8"  
 Maullänge: 10 mm  
 Jaw length: 3/8"



1/1

DIETHRICH

**BH034R**

Gesamtlänge: 48 mm  
 Total length: 1 7/8"  
 Maullänge: 13 mm  
 Jaw length: 1/2"



MILLIMETERS



### PL541S

Intestinal bulldog clip, straight, gold, 70 mm, 3.94 N, temporary clip

Product search type	Intestinal Clip
Aesculap Product	
Groups	Endoscopic Technology
Product family	Ligature Clips
Temporary / Permanent	temporary
Atraumatic	atraumatic
Geometry	straight
Jaw/Blade Length (mm)	70.00 mm
Closing Force (N)	3.94 N
Closing Force (G)	395 g
Colour	gold
Material	stainless implant steel
To be used with (code)	PL530R, PL531R
Indication	Intestinal, Laparoscopy, Thoracoscopy
Minimally Invasive	
Surg. (MIS)	Yes
Discipline	General Surgery
Surgical Step	Ligation
Data Matrix	No
Product contains Latex	No
Sterility	non-sterile
Disposable / Reusable	reusable



### PL542S

ATR.VASCULAR CLIP 25MM STR.2.45N VENOUS

Product search type	Vessel Clip
Aesculap Product	
Groups	Endoscopic Technology
Product family	Ligature Clips
Temporary / Permanent	temporary
Atraumatic	atraumatic
Geometry	straight
Jaw profile	toothing DE BAKEY
Jaw/Blade Length (mm)	25.00 mm
Closing Force (N)	2.45 N
Closing Force (G)	245 g
Colour	gold
Material	stainless implant steel
To be used with (code)	PL530R, PL531R
Indication	Vessel Artery, Laparoscopy, Vascular, Urology, Partial Nephrectomy, Thoracoscopy
Minimally Invasive	
Surg. (MIS)	Yes
Discipline	General Surgery
Surgical Step	Ligation
Data Matrix	No
Product contains Latex	No
Sterility	non-sterile
Disposable / Reusable	reusable



### PL543S

#### ATR.VASCULAR CLIP 45MM STR.2.94N VENOUS

Product search type	Vessel Clip
Aesculap Product	
Groups	Endoscopic Technology
Product family	Ligature Clips
Temporary / Permanent	temporary
Atraumatic	atraumatic
Geometry	straight
Jaw profile	toothing DE BAKEY
Jaw/Blade Length (mm)	45.00 mm
Closing Force (N)	2.94 N
Closing Force (G)	295 g
Colour	gold
Material	stainless implant steel
To be used with (code)	PL530R, PL531R
Indication	Vessel Venous, Laparoscopy, Partial Nephrectomy, Vascular, Thoracoscopy, Urology
Minimally Invasive	
Surg. (MIS)	Yes
Discipline	General Surgery
Surgical Step	Ligation
Data Matrix	No
Product contains Latex	No
Sterility	non-sterile
Disposable / Reusable	reusable



### PL544S

#### ATR.VASCULAR CLIP 25MM STR.3.43N ARTERI.

Product search type	Vessel Clip
Aesculap Product	
Groups	Endoscopic Technology
Product family	Ligature Clips
Temporary / Permanent	temporary
Atraumatic	atraumatic
Geometry	straight
Jaw profile	toothing DE BAKEY
Jaw/Blade Length (mm)	25.00 mm
Closing Force (N)	3.43 N
Closing Force (G)	345 g
Material	stainless implant steel
To be used with (code)	PL531R, PL530R
Indication	Vessel Artery, Partial Nephrectomy, Urology, Vascular, Thoracoscopy, Laparoscopy
Minimally Invasive	
Surg. (MIS)	Yes
Discipline	General Surgery
Surgical Step	Ligation
Data Matrix	No
Product contains Latex	No
Sterility	non-sterile
Disposable / Reusable	reusable



### PL545S

#### ATR.VASCULAR CLIP 45MM STR.4.41N ARTERI.

Product search type	Vessel Clip
Aesculap Product	
Groups	Endoscopic Technology
Product family	Ligature Clips
Temporary / Permanent	temporary
Atraumatic	atraumatic
Geometry	straight
Jaw profile	toothing DE BAKEY
Jaw/Blade Length (mm)	45.00 mm
Closing Force (N)	4.41 N
Closing Force (G)	445 g
Material	stainless implant steel
To be used with (code)	PL531R, PL530R
Indication	Vessel Artery, Partial Nephrectomy, Urology, Vascular, Thoracoscopy, Laparoscopy
Minimally Invasive	
Surg. (MIS)	Yes
Discipline	General Surgery
Surgical Step	Ligation
Data Matrix	No
Product contains Latex	No
Sterility	non-sterile
Disposable / Reusable	reusable



### PL546S

#### ATR.VASCULAR CLIP 25MM CVD.2.45N VENOUS

Product search type	Vessel Clip
Aesculap Product	
Groups	Endoscopic Technology
Product family	Ligature Clips
Temporary / Permanent	temporary
Atraumatic	atraumatic
Geometry	curved
Jaw profile	toothing DE BAKEY
Jaw/Blade Length (mm)	25.00 mm
Closing Force (N)	2.45 N
Closing Force (G)	245 g
Colour	gold
Material	stainless implant steel
To be used with (code)	PL531R, PL530R
Indication	Laparoscopy, Thoracoscopy, Urology, Vascular, Partial Nephrectomy, Vessel Venous
Minimally Invasive	
Surg. (MIS)	Yes
Discipline	General Surgery
Surgical Step	Ligation
Data Matrix	No
Product contains Latex	No
Sterility	non-sterile
Disposable / Reusable	reusable



### PL547S

#### ATR.VASCULAR CLIP 45MM CVD.2.94N VENOUS

Product search type	Vessel Clip
Aesculap Product Groups	Endoscopic Technology
Product family	Ligature Clips
Temporary / Permanent	temporary
Atraumatic	atraumatic
Geometry	curved
Jaw profile	toothing DE BAKEY
Jaw/Blade Length (mm)	45.00 mm
Closing Force (N)	2.94 N
Closing Force (G)	295 g
Colour	gold
Material	stainless implant steel
To be used with (code)	PL530R, PL531R
Indication	Laparoscopy, Thoracoscopy, Partial Nephrectomy, Urology, Vascular, Vessel Venous
Minimally Invasive Surg. (MIS)	Yes
Discipline	General Surgery
Surgical Step	Ligation
Data Matrix	No
Product contains Latex	No
Sterility	non-sterile
Disposable / Reusable	reusable



### PL548S

#### ATR.VASCULAR CLIP 25MM CVD.3.43N ARTERI.

Product search type	Vessel Clip
Aesculap Product Groups	Endoscopic Technology
Product family	Ligature Clips
Temporary / Permanent	temporary
Atraumatic	atraumatic
Geometry	curved
Jaw profile	toothing DE BAKEY
Jaw/Blade Length (mm)	25.00 mm
Closing Force (N)	3.43 N
Closing Force (G)	345 g
Material	stainless implant steel
To be used with (code)	PL531R, PL530R
Indication	Vessel Artery, Partial Nephrectomy, Urology, Vascular, Thoracoscopy, Laparoscopy
Minimally Invasive Surg. (MIS)	Yes
Discipline	General Surgery
Surgical Step	Ligation
Data Matrix	No
Product contains Latex	No
Sterility	non-sterile
Disposable / Reusable	reusable



### PL549S

ATR.VASCULAR CLIP 45MM CVD.4.41N ARTERI.

---

Product search type	Vessel Clip
Aesculap Product	
Groups	Endoscopic Technology
Product family	Ligature Clips
Temporary / Permanent	temporary
Atraumatic	atraumatic
Geometry	curved
Jaw profile	toothing DE BAKEY
Jaw/Blade Length (mm)	45.00 mm
Closing Force (N)	4.41 N
Closing Force (G)	445 g
Material	stainless implant steel
To be used with (code)	PL531R, PL530R
Indication	Thoracoscopy, Laparoscopy, Vascular, Urology, Partial Nephrectomy, Vessel Artery
Minimally Invasive Surg. (MIS)	Yes
Discipline	General Surgery
Surgical Step	Ligation
Data Matrix	No
Product contains Latex	No
Sterility	non-sterile
Disposable / Reusable	reusable

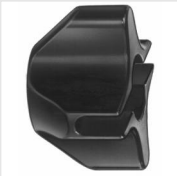

### PL664200

ROTATION KNOB



# Herz- und Gefäß-Chirurgie – Cardiovascular Surgery

## Gefäßklemmen

### Hemostatic Forceps

DE BAKEY Zahnung



Toothing DE BAKEY

AIRAUMATA®

FB

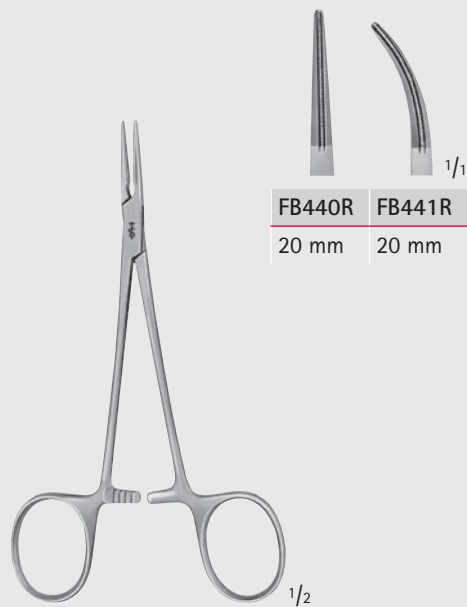

FB440R	FB441R
20 mm	20 mm

**FB440R-FB441R**  
Mosquitoklemmen  
Mosquito Forceps  
125 mm, 5"

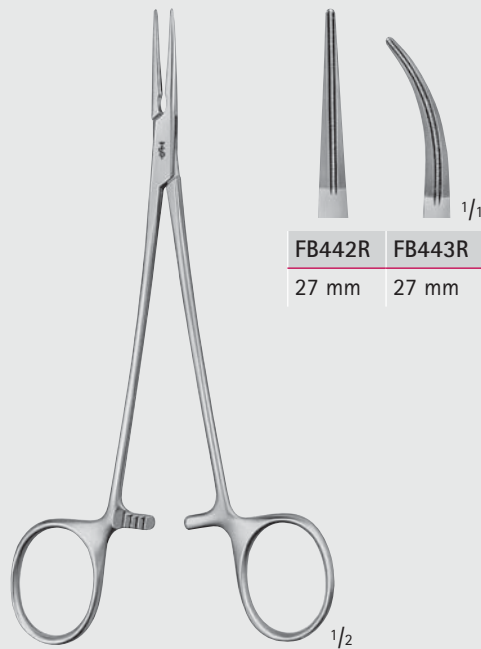

FB442R	FB443R
27 mm	27 mm

**FB442R-FB443R**  
Mosquitoklemmen  
Mosquito forceps  
165 mm, 6 1/2"



FB446R	FB447R
40 mm	40 mm

**FB446R-FB447R**  
DE BAKEY-BAINBRIDGE  
155 mm, 6"



FB448R	FB449R
65 mm	65 mm

**FB448R-FB449R**  
DE BAKEY-BAINBRIDGE  
180 mm, 7"

# Cardiovascular

## Vascular Clamps

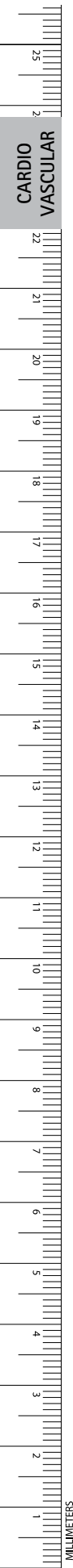

CARDIO  
VASCULAR

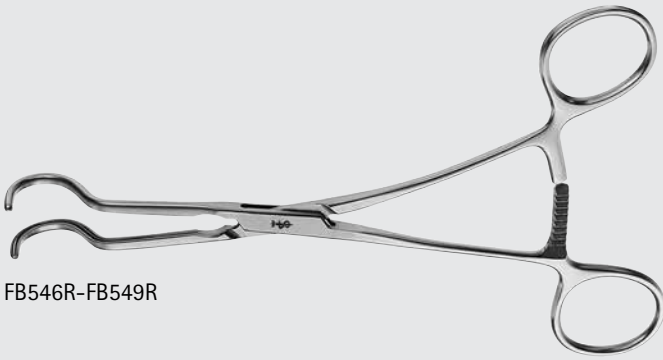

FB546R-FB549R

### DALE Femoral Popliteal Clamp

Catalog Number	Jaw	Length (in.)
FB546R	SMALL	6 7/8
FB547R	MEDIUM	7
FB548R	LARGE	7
FB549R	-	7

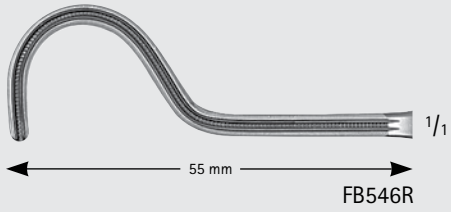

FB546R

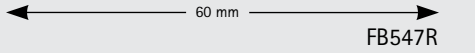
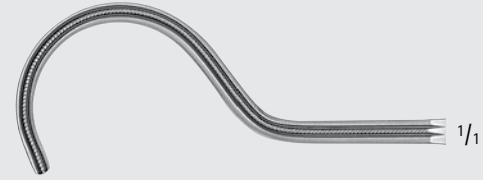

FB547R

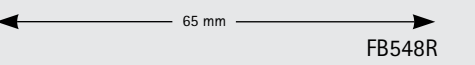
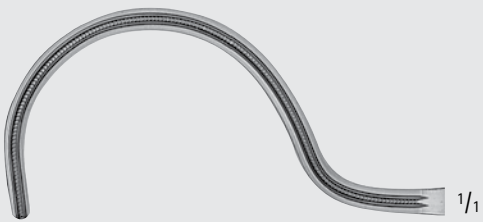

FB548R



FB549R

# Cardiovascular

## Vascular Clamps

### DEBAKEY-PEAN Atraumatic Forceps

Catalog Number	Jaw	Jaw Length (mm)	Length (in.)
FB526R	STR	60	7 7/8
FB532R	STR	89	10 1/2
FB534R	STR	99	11
FB527R	CVD	60	7 7/8
FB533R	CVD	89	10 1/4
FB535R	CVD	99	10 3/4



FB526R-FB535R



FB526R



FB532R



FB534R



FB527R

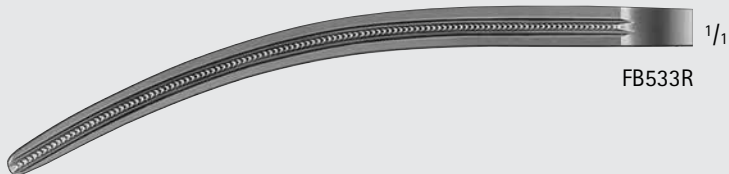

FB533R

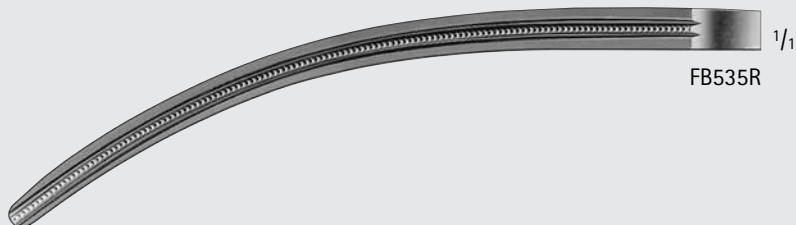

FB535R



INCHES



# Herz- und Gefäß-Chirurgie – Cardiovascular Surgery

## Gefäßklemmen Vascular Clamps

FB



BABY-SATINSKY

**FB600R**

Anastomosen-Klemme

Anastomosis clamp

$1/2$  150 mm, 6"



SATINSKY

**FB602R**

Anastomosen-Klemme

Anastomosis clamp

265 mm, 10  $1/2$ "

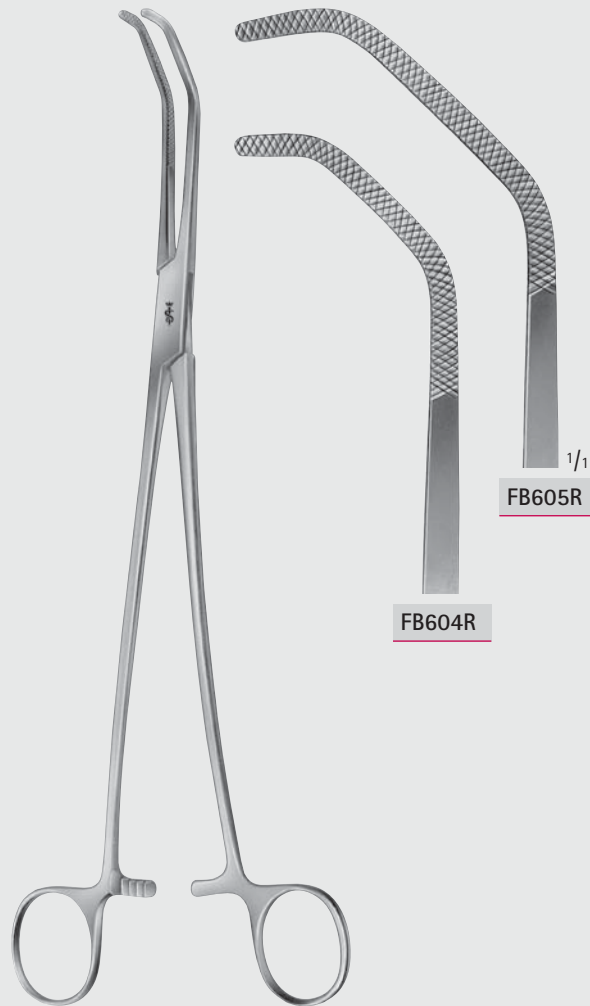

SATINSKY

**FB604R-FB605R**

Anastomosen-Klemmen

Anastomosis clamps

265 mm, 10  $1/2$ "



Cardiovascular  
Vascular Clamps



HENLY Atraumatic Clamp

Catalog Number	Jaw Length (mm)	Length (in.)
FB617R	75	7 7/8

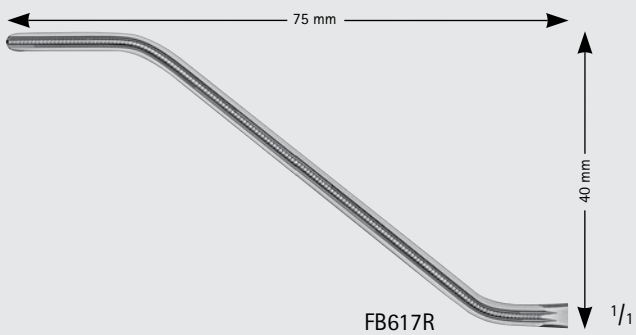

INCHES

# Cardiovascular

## Vascular Clamps

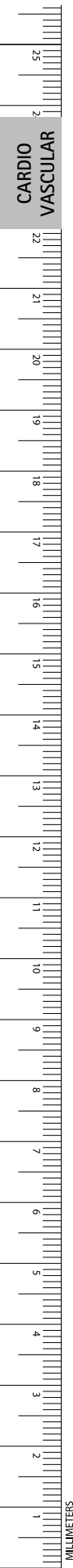

CARDIO  
VASCULAR

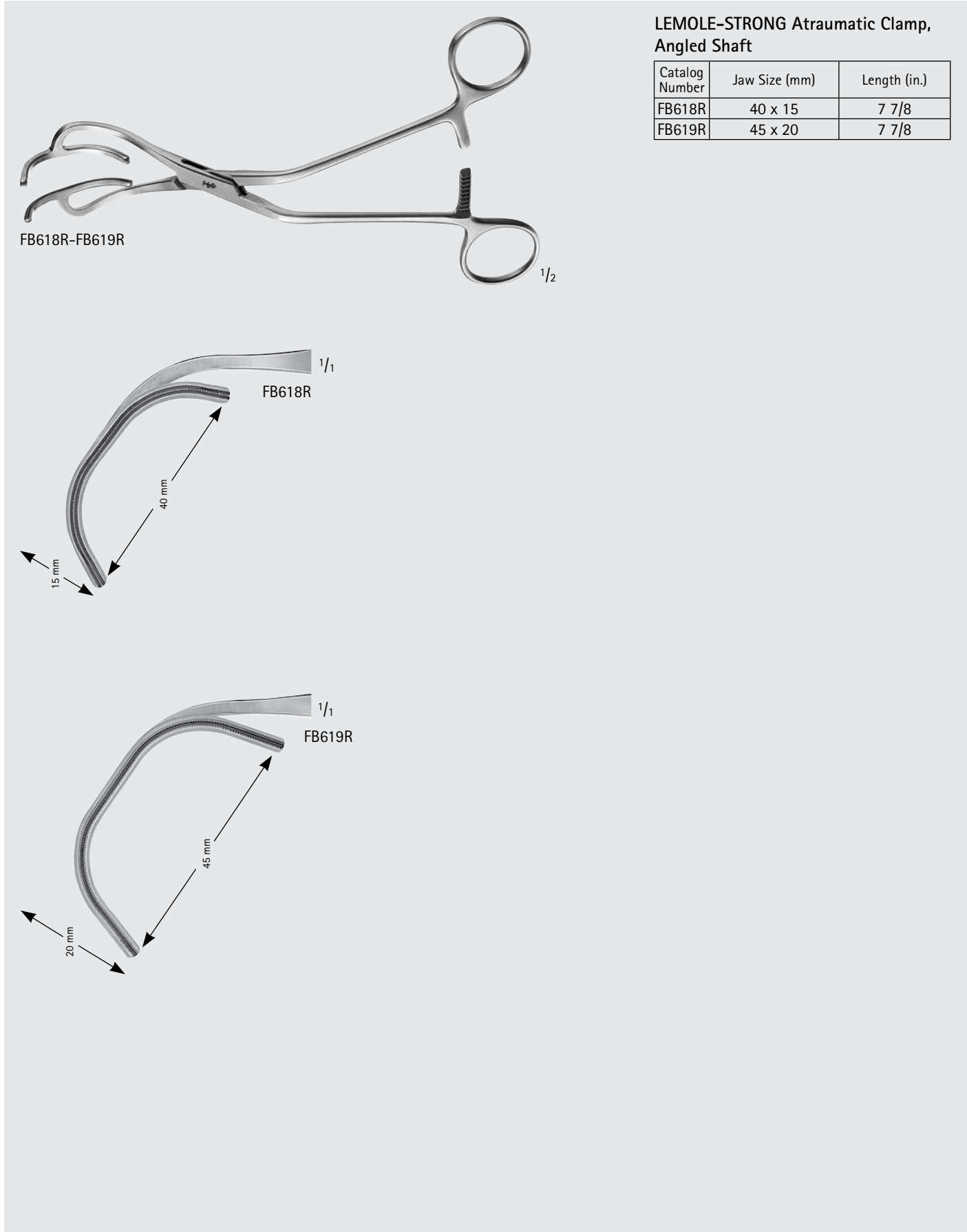

### LEMOLE-STRONG Atraumatic Clamp, Angled Shaft

Catalog Number	Jaw Size (mm)	Length (in.)
FB618R	40 x 15	7 7/8
FB619R	45 x 20	7 7/8

# Herz- und Gefäß-Chirurgie – Cardiovascular Surgery

## Gefäßklemmen

### Vascular Clamps

FB



FB633R

federnd  
elastic

CRAFOORD-SELLORS

FB633R

240 mm, 9 1/2"



FB634R

federnd  
elastic

FB635R

CRAFOORD

FB634R-FB635R

240 mm, 9 1/2"

# Cardiovascular

## Vascular Clamps



CARDIO  
VASCULAR

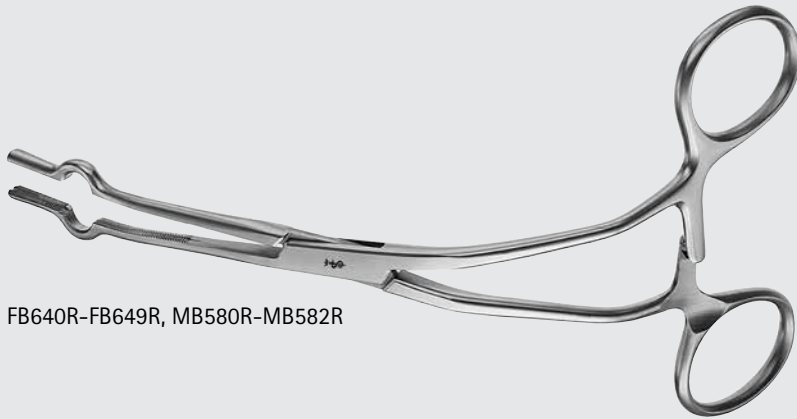

FB640R-FB649R, MB580R-MB582R

### COOLEY Cava Occlusion Clamp

Catalog Number	Jaw Size (FR)	Length (in.)
FB640R	20	6 1/4
FB641R	24	6 1/4
FB642R	26	7 1/2
MB580R	28	7 1/2
FB644R	30	7 1/2
MB581R	32	7 1/2
MB582R	34	7 1/2
FB647R	36	7 1/2
FB649R	40	7 1/2



FB640R



FB642R



FB644R



MB582R



FB649R



FB641R



MB580R



MB581R



FB647R

MILLIMETERS



# Cardiovascular Vascular Clamps

## WYLIE Atraumatic Clamp

Catalog Number	Jaw	Length (in.)
FB669R	HEAVY-CVD	8 3/4
FB670R	CVD-BACK	9



FB669R-FB670R

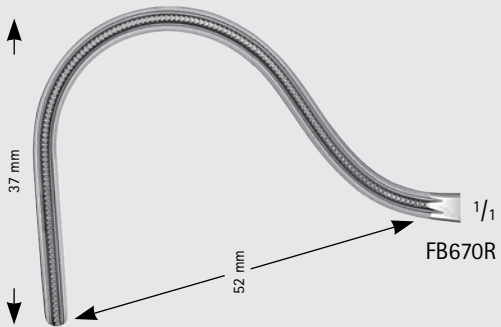
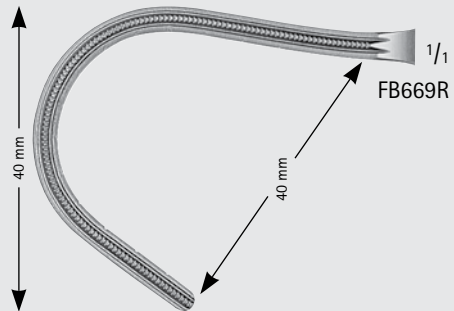

CARDIO  
VASCULAR

# Cardiovascular

## Vascular Clamps

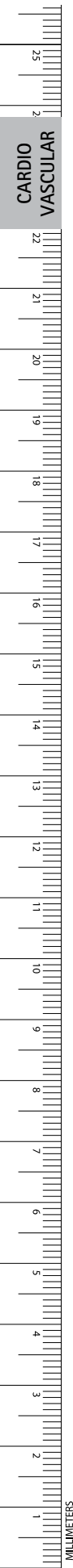

CARDIO  
VASCULAR

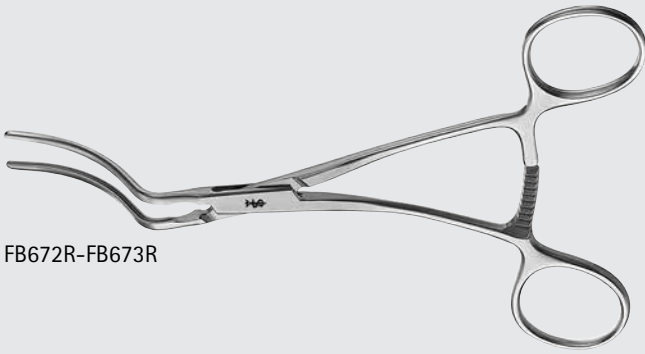

FB672R-FB673R

### WYLIE Atraumatic Clamp

Catalog Number	Jaw	Length (in.)
FB672R	CVD-UP	6 1/4
FB673R	CVD-UP	7

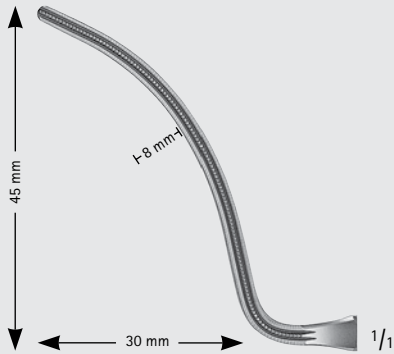

FB672R

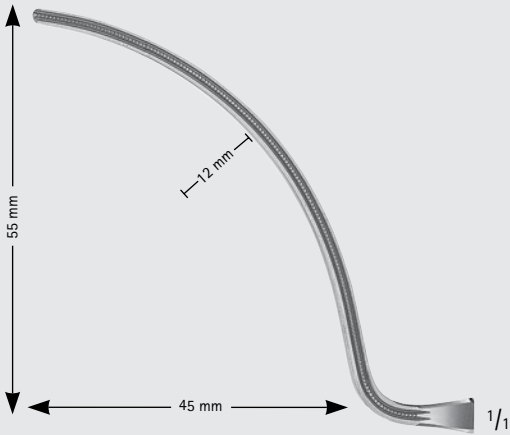

FB673R

**DERRA-COOLEY Atraumatic Clamp**

Catalog Number	Jaw Length (mm)	Length (in.)
FB725R	16	6 3/4
FB726R	21	6 7/8
FB727R	27	6 7/8

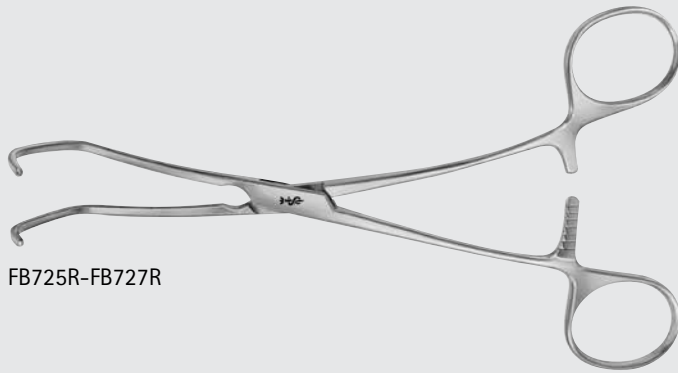

FB725R-FB727R

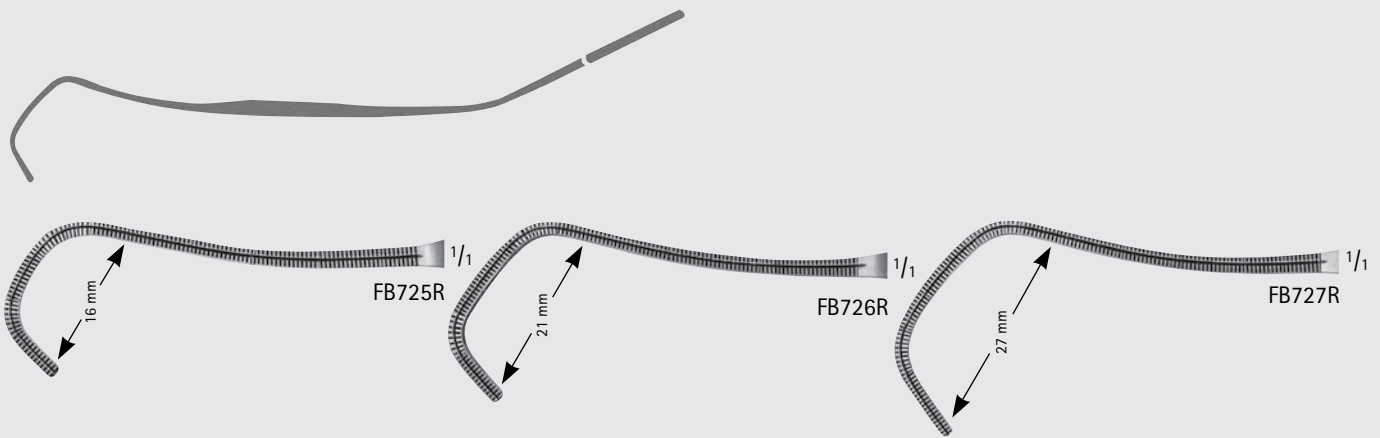

**COOLEY Atraumatic Clamp, Spoon Shaped**

Catalog Number	Jaw Length (mm)	Length (in.)
FB743R	42	5 3/4

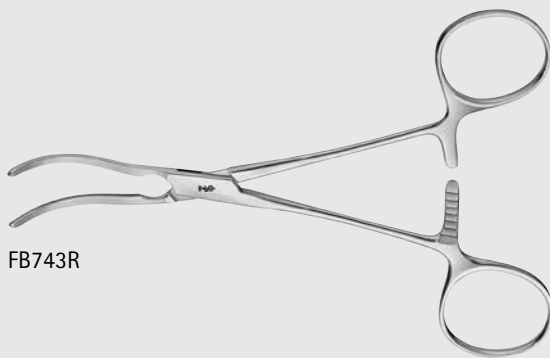

FB743R



**COOLEY-SATINSKY Atraumatic Pediatric Clamp**

Catalog Number	Jaw Length (mm)	Length (in.)
MB613R	21	5 1/2

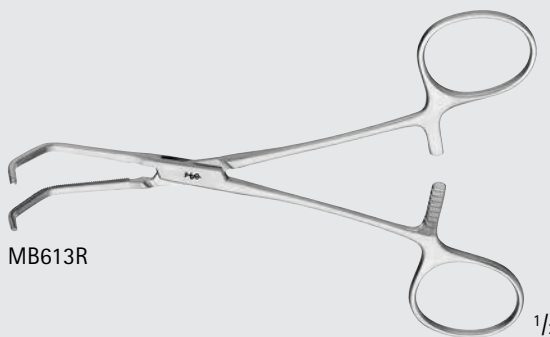

MB613R

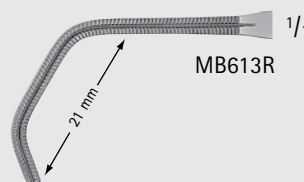

MB613R



# Cardiovascular

## Vascular Clamps

### GREGORY Atraumata Profunda Clamp

Catalog Number	Jaw	Jaw Length (mm)	Length (in.)
MG014R	X-SMALL	29	5
MB750R	SMALL	57	5 3/4
MB751R	MEDIUM	62	7
MB752R	LARGE	75	7 3/4

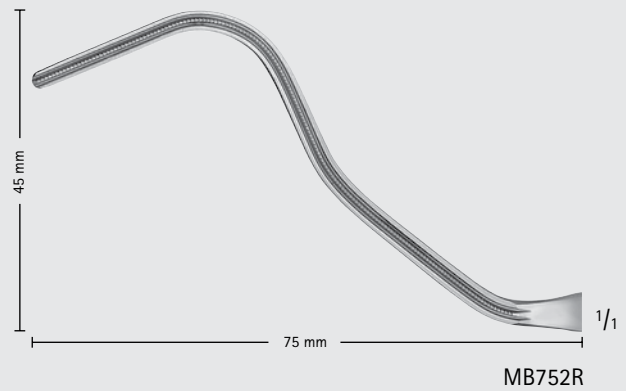
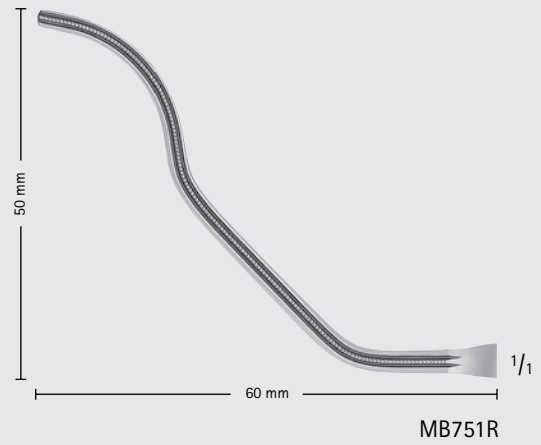
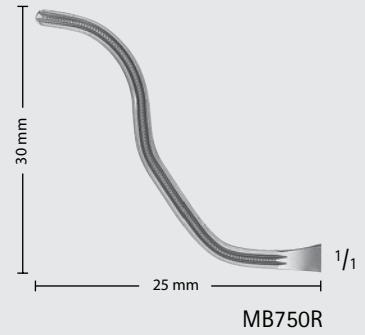
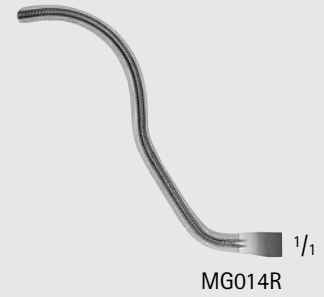
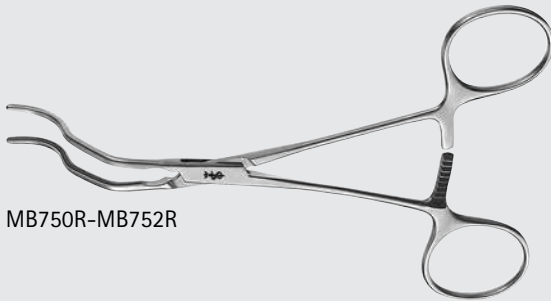
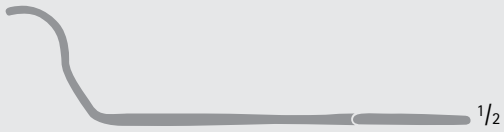
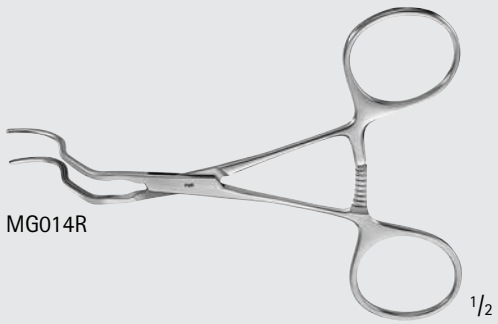

## Herz- und Gefäß-Chirurgie – Cardiovascular Surgery

Fixierklemme, Carotis Shunt Klemmen

Fixation Clamp, Carotid Shunt Clamps

FB



**MB238R**

168 mm

6 <sup>5</sup>/<sub>8</sub>"

**MB239R**

180 mm

7"

<sup>1</sup>/<sub>1</sub>

JAVID

**MB238R-MB239R**

Carotis Shunt Klemmen

Carotid shunt clamps

# Cardiovascular

## Bulldog and Micro Vessel Clamps

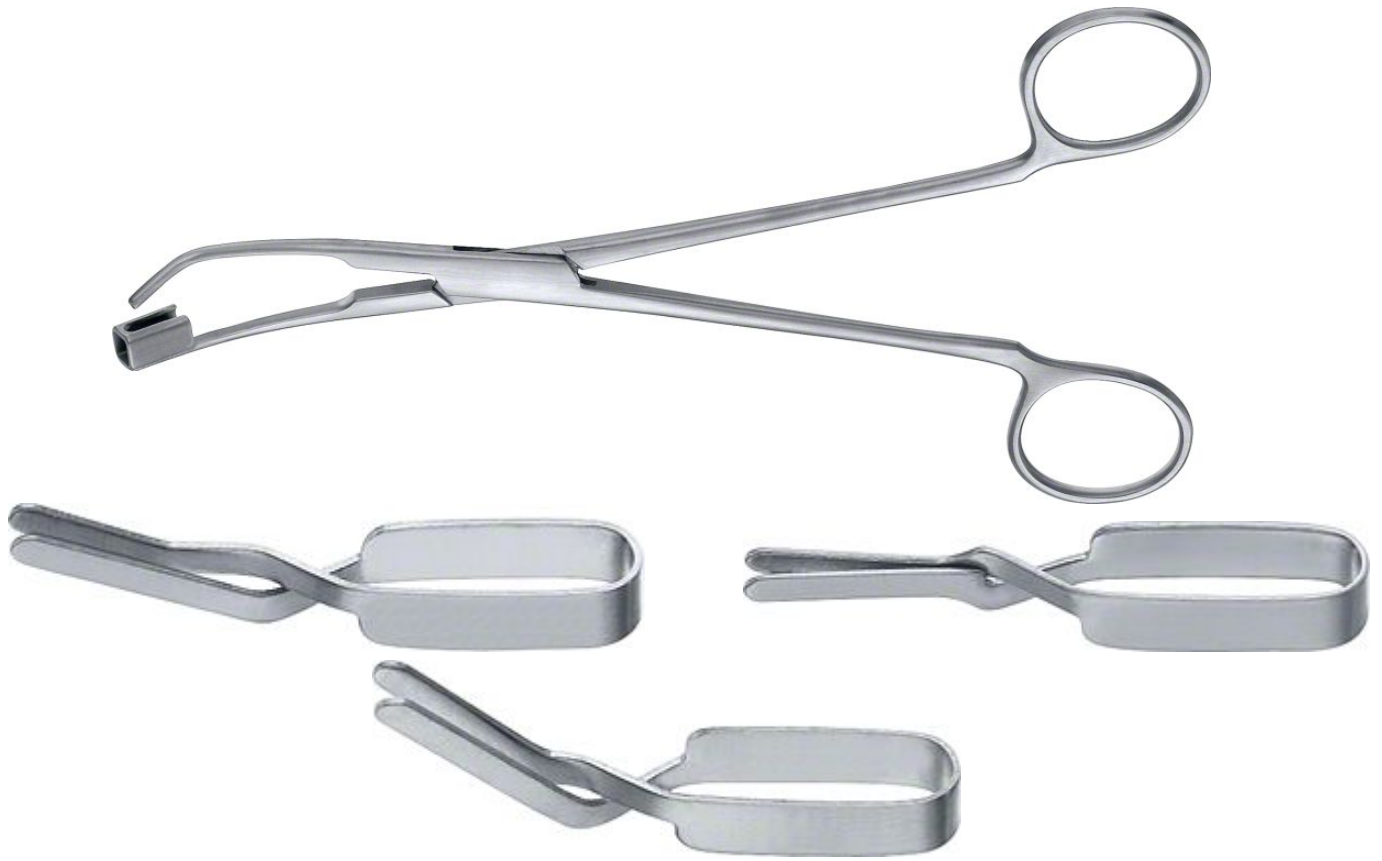

### SCHWARTZ Apply/Remove Forceps

Catalog Number	Length (in.)
FD628R	7 1/2

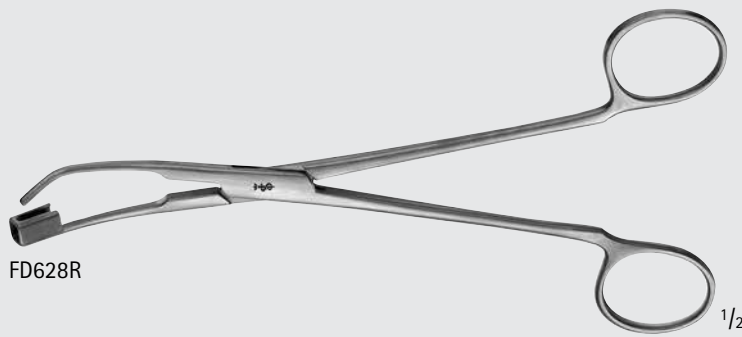

FD628R

1/2

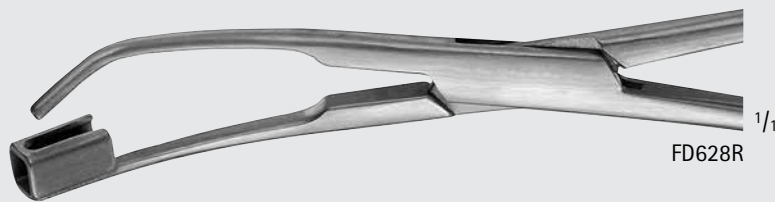

FD628R

1/1



FD622R

1/1



FD623R

1/1



FD624R

1/1

### SCHWARTZ Micro-Vessel Clamp, Cross-Serrated

Catalog Number	Jaw	Jaw Length (mm)	Closing Force	Length (in.)
FD622R	STR	8	400G	1
FD623R	25°	8	400G	1
FD624R	45°	8	400G	1



MILLIMETERS

# Plastic Surgery

## Micro Vessel Clips and Clamps

- The arterial clips have a slightly inwards curved jaw tip to prevent slipping, see Fig.1
- The venous clips have a flat parallel closing jaw, see Fig. 2

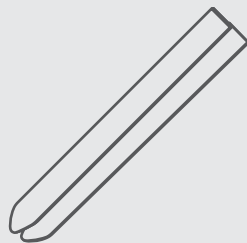

Fig. 1

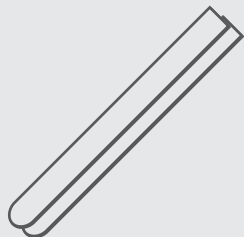
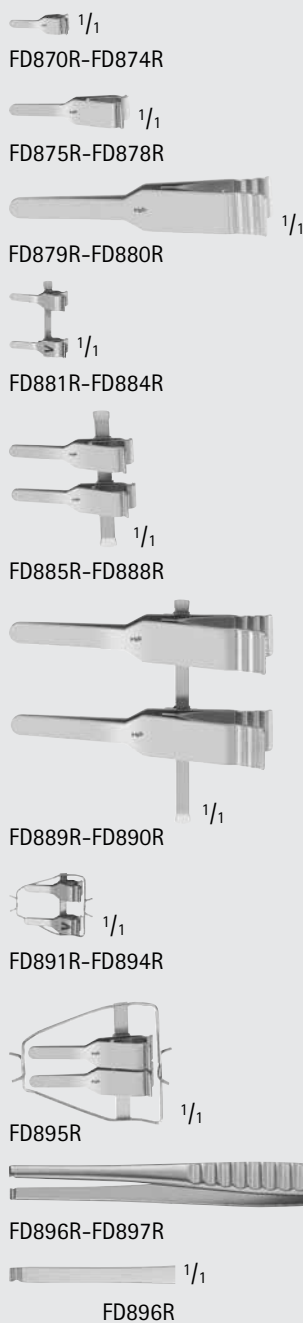

Fig. 2



### ACLAND Micro Vessel Clips

Catalog Number	Jaw Length (mm)	Size	Description	Vessel Size (mm)
FD870R	8	B-1	Artery	0.3-1.0
FD871R	8	B-1	Vein	0.3-1.0
FD872R	11	B-2	Artery	0.6-1.4
FD873R	11	B-2	Vein	0.6-1.4
FD874R	16	B-3	Artery	1.0-2.2
FD875R	16	B-3	Vein	1.0-2.2
FD876R	24	HD-S	Artery	1.5-3.3
FD877R	24	HD-S	Vein	1.5-3.3
FD878R	35	RD-S	Artery	2.0-5.0
FD879R	35	RD-S	Vein	2.0-5.0
FD880R	8	B-1	Artery	0.3-1.0
FD881R	8	B-1	Vein	0.3-1.0
FD882R	11	B-2	Artery	0.6-1.4
FD883R	11	B-2	Vein	0.6-1.4
FD884R	16	B-3	Artery	1.0-2.2
FD885R	16	B-3	Vein	1.0-2.2
FD886R	24	HD-D	Artery	1.5-3.3
FD887R	24	HD-D	Vein	1.5-3.3
FD888R	35	RD-D	Artery	2.0-5.0
FD889R	35	RD-D	Vein	2.0-5.0
FD890R	8	B-1	Artery	0.3-1.0
FD891R	8	B-1	Vein	0.3-1.0
FD892R	11	B-2	Artery	0.6-1.4
FD893R	11	B-2	Vein	0.6-1.4
FD894R	16	B-3	Artery	1.0-2.2
FD895R	16	B-3	Vein	1.0-2.2
FD896R	5 1/2	B-1, B-2	Clip Applying Forceps	-
FD897R	5 1/2	B-3, HD, RD	Clip Applying Forceps	-

All items are sold individually

PLASTIC SURGERY

MILLIMETERS



# Arterienklemmen – Hemostatic Forceps

Gefäßclips  
Vessel Clips

BH

Schließdruck Closing force					
50 g	<u>FE010K</u>	<u>FE011K</u>	<u>FE012K</u>	<u>FE013K</u>	<u>FE014K</u>
80 g	<u>FE020K</u>	<u>FE021K</u>	<u>FE022K</u>	<u>FE023K</u>	<u>FE024K</u>
	gerade straight	gebogen curved	Spitze gebogen curved tips	zur Seite abgewinkelt angled to side	kniegebogen knee-bent

## MÜLLER

FE010K-FE024K

Temporäre Gefäßclips mit atraumatischem Maulprofil  
Non-traumatic vessel clips, temporary



1/1  
Maulprofil fein kariert  
jaw profiles, finally  
cross-serrated

## MÜLLER

FE005K

Fadenklemme  
Ligature Forceps



MILLIMETERS



# Arterienklemmen – Hemostatic Forceps

Gefäßclips

Vascular Clips

DE BAKEY Zahnung



Toothing DE BAKEY

Gefäßclips nach MÜLLER

### Merkmale:

- Atraumatisches Maulprofil
- Beidseitig angebrachte Griffplateaus zum sicheren Anlegen und Abnehmen des Clips.
- Exakt definierter Schließdruck für arterielle und venöse Gefäße.
- Gefäßclips eindeutig mit Schließdruck gekennzeichnet.
- Geschlossener Maulkasten zur sicheren Maulführung. Kein ungewolltes Verfangen des Fadens möglich.

MÜLLER Vascular Clips

### Features:

- Atraumatic mouth profile
- Handle plateau mounted on both sides for secure application and removal of the clip.
- Exactly defined closing pressure for arterial and venous vessels.
- Vascular clips are clearly marked with closing pressure.
- Closed mouth box guarantees precise guidance of the working tips. No risk of threads getting tangled up in clip.

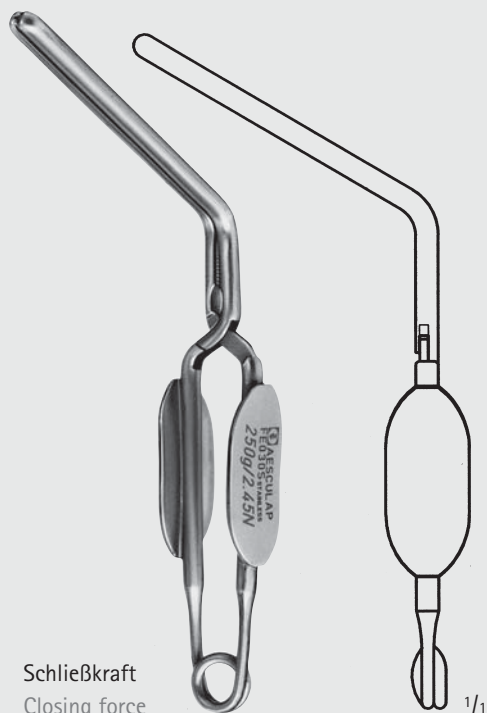

Schließkraft  
Closing force

MÜLLER

250 g **FE030S**

350 g **FE040S**

gerade  
straight

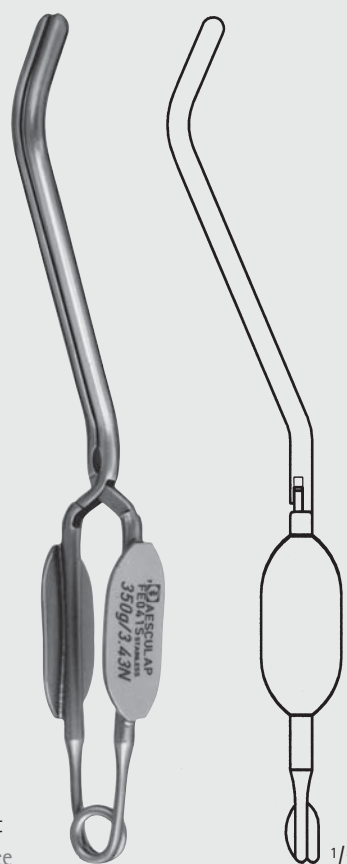

Schließkraft  
Closing force

MÜLLER

250 g **FE031S**

350 g **FE041S**

gebogen  
curved



DE BAKEY Zahnung



Toothing DE BAKEY

## Arterienklemmen – Hemostatic Forceps

Gefäßclips

Vascular Clips

BH



Schließkraft  
Closing force

MÜLLER

250 g **FE032S**

350 g **FE042S**

Spitze gebogen  
curved tips

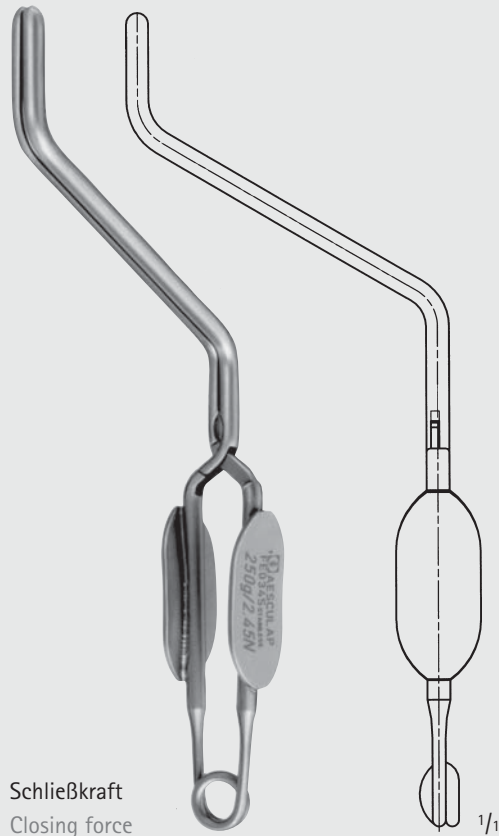

Schließkraft  
Closing force

MÜLLER

250 g **FE034S**

350 g **FE044S**

kniegebogen  
knee-bent

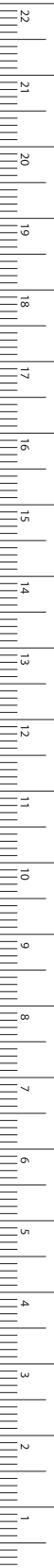

MILLIMETERS

**По вопросам продаж и поддержки обращайтесь:**

Алматы (7273)495-231	Казань (843)206-01-48	Новокузнецк (3843)20-46-81	Смоленск (4812)29-41-54
Архангельск (8182)63-90-72	Калининград (4012)72-03-81	Новосибирск (383)227-86-73	Сочи (862)225-72-31
Астрахань (8512)99-46-04	Калуга (4842)92-23-67	Омск (3812)21-46-40	Ставрополь (8652)20-65-13
Барнаул (3852)73-04-60	Кемерово (3842)65-04-62	Орел (4862)44-53-42	Сургут (3462)77-98-35
Белгород (4722)40-23-64	Киров (8332)68-02-04	Оренбург (3532)37-68-04	Тверь (4822)63-31-35
Брянск (4832)59-03-52	Краснодар (861)203-40-90	Пенза (8412)22-31-16	Томск (3822)98-41-53
Владивосток (423)249-28-31	Красноярск (391)204-63-61	Пермь (342)205-81-47	Тула (4872)74-02-29
Волгоград (844)278-03-48	Курск (4712)77-13-04	Ростов-на-Дону (863)308-18-15	Тюмень (3452)66-21-18
Вологда (8172)26-41-59	Липецк (4742)52-20-81	Рязань (4912)46-61-64	Ульяновск (8422)24-23-59
Воронеж (473)204-51-73	Магнитогорск (3519)55-03-13	Самара (846)206-03-16	Уфа (347)229-48-12
Екатеринбург (343)384-55-89	Москва (495)268-04-70	Санкт-Петербург (812)309-46-40	Хабаровск (4212)92-98-04
Иваново (4932)77-34-06	Мурманск (8152)59-64-93	Саратов (845)249-38-78	Челябинск (351)202-03-61
Ижевск (3412)26-03-58	Набережные Челны (8552)20-53-41	Севастополь (8692)22-31-93	Череповец (8202)49-02-64
Иркутск (395)279-98-46	Нижний Новгород (831)429-08-12	Симферополь (3652)67-13-56	Ярославль (4852)69-52-93
Россия (495)268-04-70	Киргизия (996)312-96-26-47	Казахстан (7172)727-132	