

Технические характеристики

По вопросам продаж и поддержки обращайтесь:

Алматы (7273)495-231	Казань (843)206-01-48	Новокузнецк (3843)20-46-81	Смоленск (4812)29-41-54
Архангельск (8182)63-90-72	Калининград (4012)72-03-81	Новосибирск (383)227-86-73	Сочи (862)225-72-31
Астрахань (8512)99-46-04	Калуга (4842)92-23-67	Омск (3812)21-46-40	Ставрополь (8652)20-65-13
Барнаул (3852)73-04-60	Кемерово (3842)65-04-62	Орел (4862)44-53-42	Сургут (3462)77-98-35
Белгород (4722)40-23-64	Киров (8332)68-02-04	Оренбург (3532)37-68-04	Тверь (4822)63-31-35
Брянск (4832)59-03-52	Краснодар (861)203-40-90	Пенза (8412)22-31-16	Томск (3822)98-41-53
Владивосток (423)249-28-31	Красноярск (391)204-63-61	Пермь (342)205-81-47	Тула (4872)74-02-29
Волгоград (844)278-03-48	Курск (4712)77-13-04	Ростов-на-Дону (863)308-18-15	Тюмень (3452)66-21-18
Вологда (8172)26-41-59	Липецк (4742)52-20-81	Рязань (4912)46-61-64	Ульяновск (8422)24-23-59
Воронеж (473)204-51-73	Магнитогорск (3519)55-03-13	Самара (846)206-03-16	Уфа (347)229-48-12
Екатеринбург (343)384-55-89	Москва (495)268-04-70	Санкт-Петербург (812)309-46-40	Хабаровск (4212)92-98-04
Иваново (4932)77-34-06	Мурманск (8152)59-64-93	Саратов (845)249-38-78	Челябинск (351)202-03-61
Ижевск (3412)26-03-58	Набережные Челны (8552)20-53-41	Севастополь (8692)22-31-93	Череповец (8202)49-02-64
Иркутск (395)279-98-46	Нижний Новгород (831)429-08-12	Симферополь (3652)67-13-56	Ярославль (4852)69-52-93
Россия (495)268-04-70	Киргизия (996)312-96-26-47	Казахстан (7172)727-132	



Wundhaken – Wound Retractors

Wundhaken, Bauchdeckenhaken
Retractors, Abdominal Retractors

BT

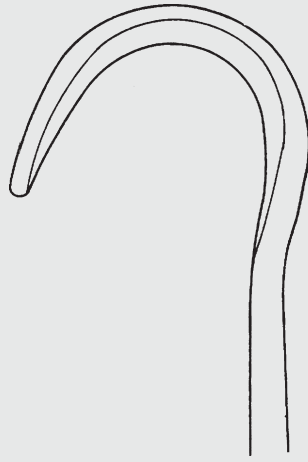

BT655R

Fig. 1
32 x 40 mm

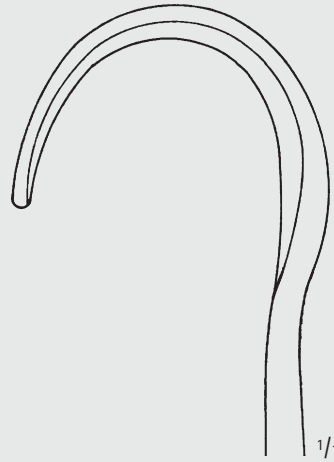

BT656R

Fig. 2
34 x 50 mm

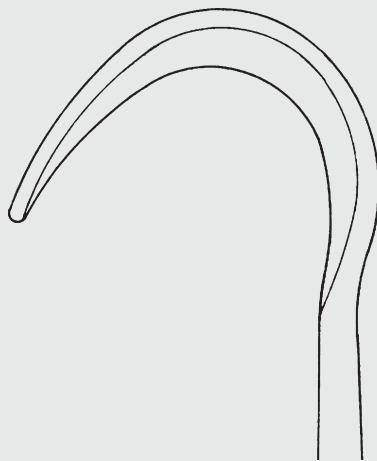

BT657R

Fig. 3
41 x 60 mm

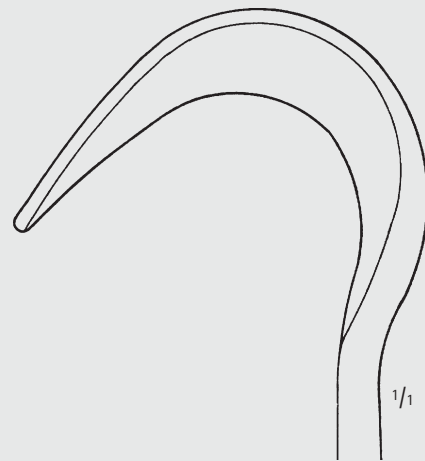

BT658R

Fig. 4
46 x 75 mm



FRITSCH

BT655R-BT659R

235 mm, 9 1/4"

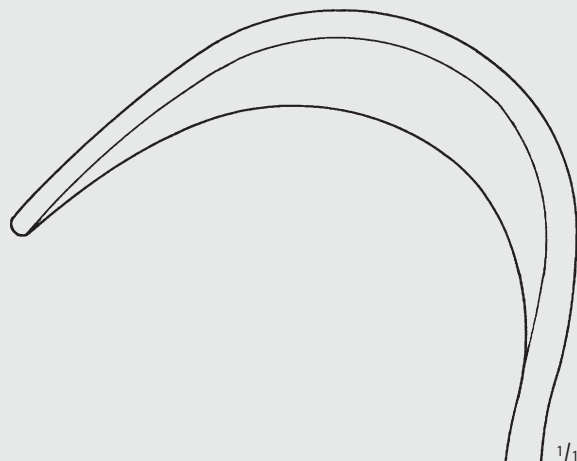

BT659R

Fig. 5
64 x 85 mm

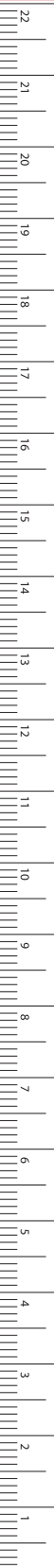

MILLIMETERS

Wundhaken – Wound Retractors

Wundhaken, Bauchdeckenhaken

Retractors, Abdominal Retractors

Maßangaben für Blattgrößen der Wundhaken

1. Zahl = Tiefe Beispiel: 25 x 38 mm

2. Zahl = Breite

Dimensions for blade size of retractors

1st number = depth Example: 25 x 38 mm

2nd number = width

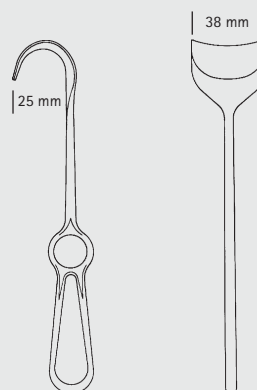

DOYEN

BT667R

250 mm, 10"

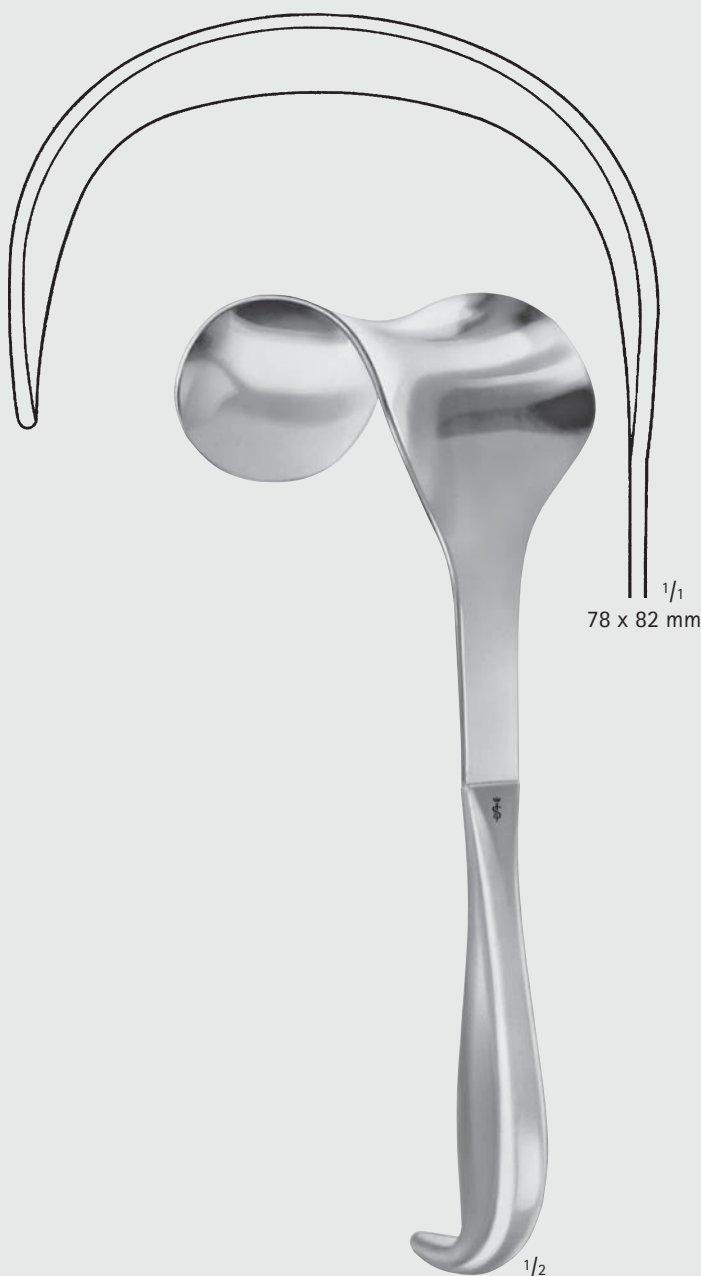

DOYEN

BT669R

260 mm, 10 $\frac{1}{4}$ "

BT



INCHES



Wundhaken – Wound Retractors

Bauchdeckenhaken
Abdominal Retractors

BT



¹/₃

DOYEN

BT721R	48 x 90 mm
BT723R	48 x 105 mm
BT724R	48 x 120 mm
BT725R	48 x 135 mm

280 mm, 11"



BT703R

Kette (BT704R) mit Gewicht (EL747R/645 g)
Chain (BT704R) with weight (EL747R/645 g)
790 mm, 31"

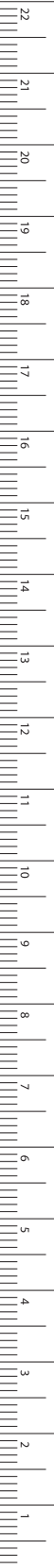

MILLIMETERS

Wundhaken – Wound Retractors

Bauchdeckenhaken

Abdominal Retractors

BT

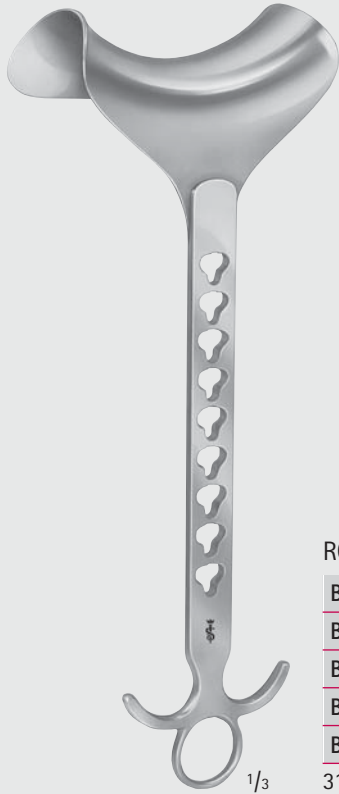

ROCHARD

BT711R	48 x 90 mm
BT712R	48 x 105 mm
BT713R	48 x 120 mm
BT714R	48 x 135 mm
BT715R	48 x 155 mm

310 mm, 12 1/4"

1/3

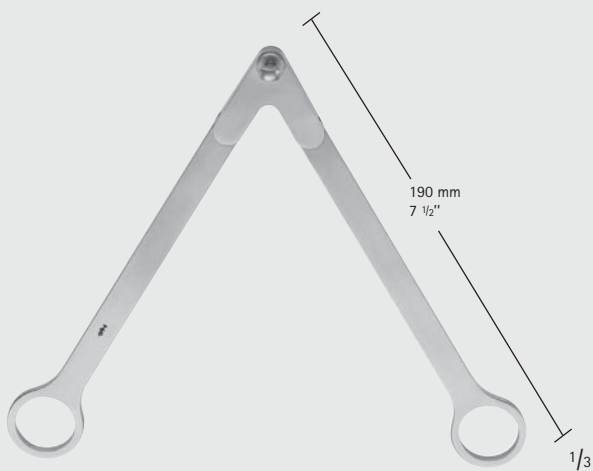

ROCHARD

BT710R

Fixiervorrichtung für
BT711R - BT715R

Fixation device for
BT711R - BT715R

190 mm, 8"

1/3



ROCHARD

BT710R-BT711R

1/3



Wundhaken – Wound Retractors

Bauchdeckenhaken Abdominal Retractors

BT

Befestigungsgestelle zu verwenden mit:
BT710R Fixiervorrichtung und
BT711R - BT715R ROCHARD Bauchdeckenhalter
Mounting frames to be used with:
BT710R Fixation device and
BT711R - BT715R ROCHARD abdominal retractors

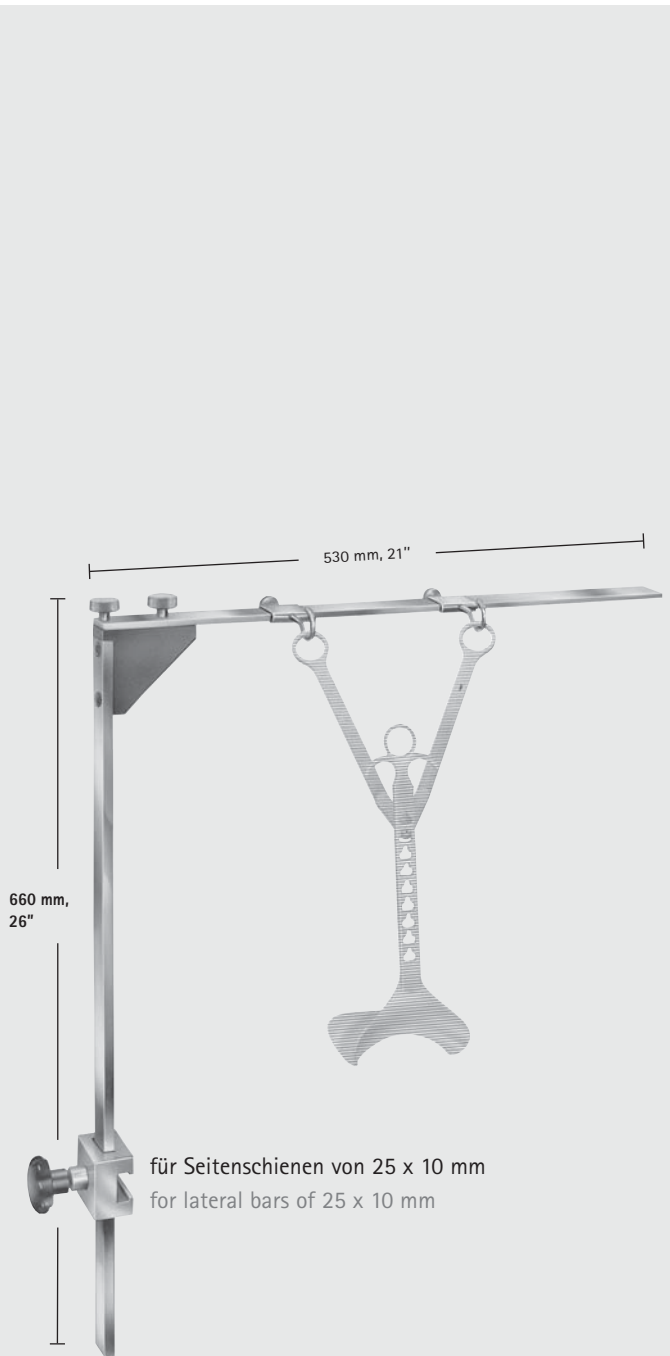

ROCHARD

BT709R

Befestigungsgestell zur Fixierung an den Seitenschienen der OP-Tische, zerlegbar zur Aufbereitung und Sterilisation.

Mounting frame for fastening to the lateral bars of the operating tables, can be dismantled for decontamination and sterilization.

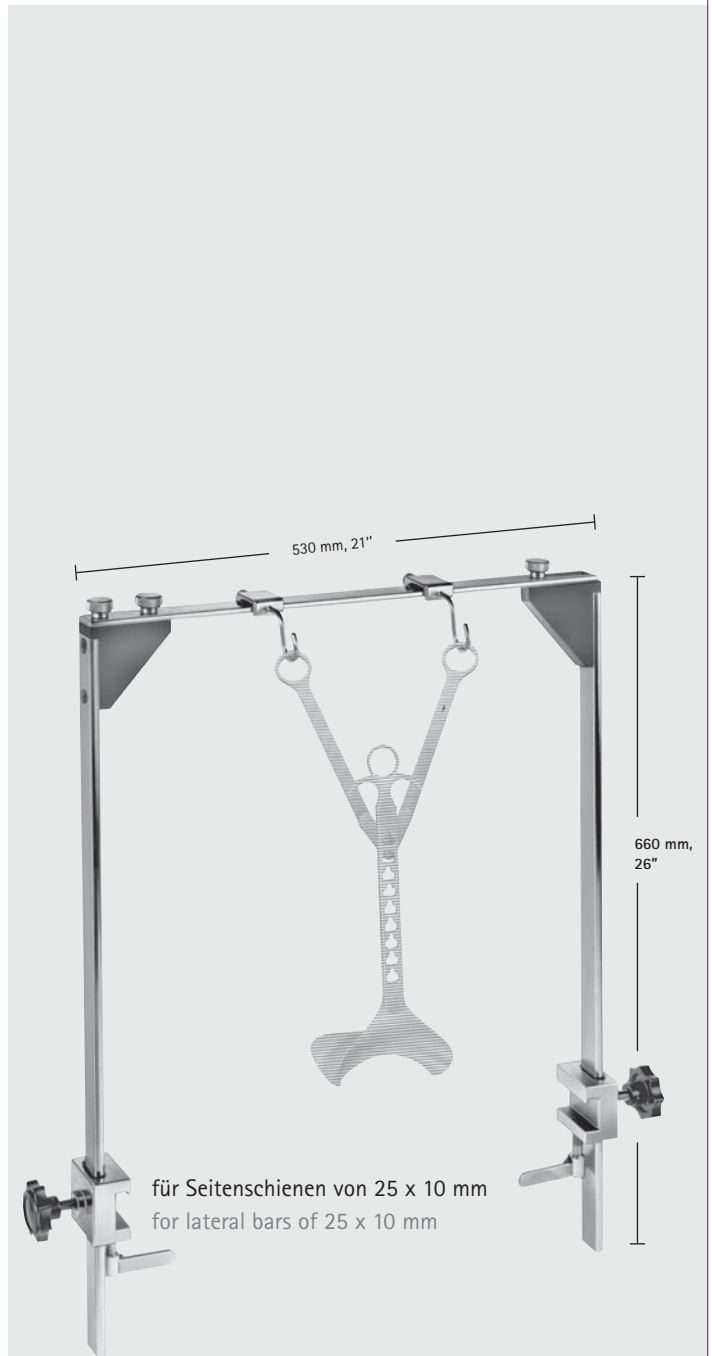

ROCHARD

BT708R

Befestigungsgestell mit beidseitiger Fixierung an den Seitenschienen der OP-Tische, dadurch mehr Stabilität, zur Aufbereitung und Sterilisation zerlegbar.

Mounting frame for fastening to both sides of the is given, can be dismantled for decontamination and sterilization.



MILLIMETERS

Wundhaken – Wound Retractors

Bauch- und Darmspatel

Abdominal and Intestinal Spatulas

BT



REVERDIN

BT749R

285 mm, 11 1/4"



HABERER

BT758R

biegsam
malleable
305 mm, 12"



RIBBON

BT756R	25 mm
BT761R	30 mm
BT762R	40 mm
BT763R	50 mm

biegsam
malleable
330 mm, 13 1/8"



TUFFIER

BT750R

biegsam
malleable
200 mm, 8"



BT751R	12 mm	200 mm	8"
BT752R	17 mm	200 mm	8"
BT755R	25 mm	250 mm	10"

biegsam
malleable

Wundspreizer, Bauchdeckenhalter – Self-Retaining Retractors, Abdominal Retractors

Bauchdeckenhalter

Abdominal Retractors

KUGELSCHNELLVERSCHLUSS
BALL SNAP CLOSURE



BV

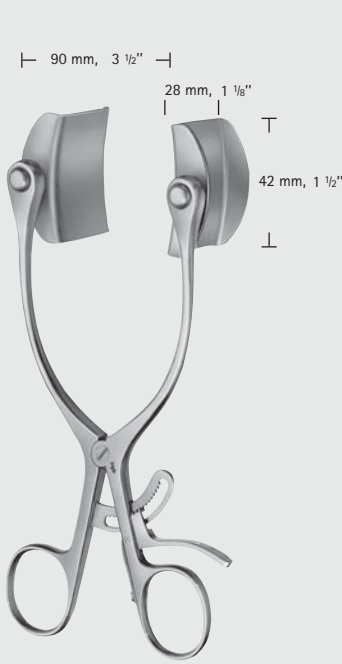

BABY-COLLIN

BV329R

Sperrer komplett,
bestehend aus:
BV327R Sperrer allein
BV326R Blätter (Paar)
18 x 42 mm
BV328R Blätter (Paar)
28 x 42 mm

Retractor complete,
consisting of:
BV327R Spreader only
BV326R Blades (pair)
18 x 42 mm
BV328R Blades (pair)
28 x 42 mm



COLLIN

BV530R

Sperrer komplett,
bestehend aus:
BV520R Sperrer allein
BV511R Blätter (Paar)

Retractor complete,
consisting of:
BV520R Spreader only
BV511R Blades (pair)



COLLIN

BV531R-BV533R

komplett complete	BV531R	BV532R	BV533R
Sperrer allein	BV522R	BV523R	BV523R
Spreader only			
Seitl. Blätter (Paar) Lateral blades (pair)	BV551R 37 x 62 mm	BV552R 37 x 80 mm	BV553R 37 x 98 mm
Mittelblatt Center blade	BV361R 54 x 55 mm	BV362R 54 x 67 mm	BV363R 52 x 76 mm



COLLIN

BV535R-BV536R

komplett complete	BV535R	BV536R
Sperrer allein	BV524R	BV524R
Spreader only		
Seitl. Blätter (Paar) Lateral blades (pair)	BV555R 48 x 59 mm	BV554R 61 x 80 mm
Mittelblatt Center blade	BV338R 63 x 74 mm	BV338R 63 x 74 mm



Wundspreizer, Bauchdeckenhalter – Self-Retaining Retractors, Abdominal Retractors

 KUGELSCHNELLVERSCHLUSS
BALL SNAP CLOSURE

Bauchdeckenhalter
Abdominal Retractors

BV

320 mm, 12 1/2"



RICARD

BV542R-BV543R

komplett		
complete	BV542R	BV543R
Sperrer allein	BV527R	BV527R
Spreader only		
Seitl. Blätter (Paar)	BV556R	BV557R
Lateral blades (pair)	58 x 80 mm	72 x 84 mm
Mittelblatt	BV366R	BV367R
Center blade	54 x 70 mm	72 x 90 mm

275 mm, 10 3/4"



HOLZBACH

BV545R

komplett		
complete		
Seitl. Blätter (Paar)	BV558R	
Lateral blades (pair)	59 x 80 mm	
Mittelblatt		BV369R
Center blade		74 x 82 mm

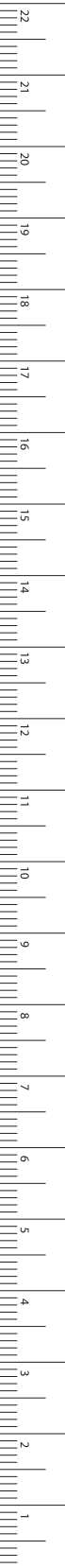

MILLIMETERS



Wundspreizer, Bauchdeckenhalter – Self-Retaining Retractors, Abdominal Retractors

Bauchdeckenhalter
Abdominal Retractors

BV

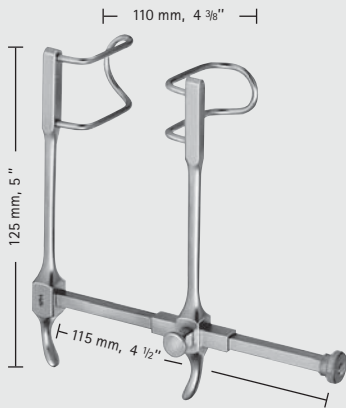

GOSSET

BV500R

Blätter: 38 mm tief

Blades: 38 mm deep

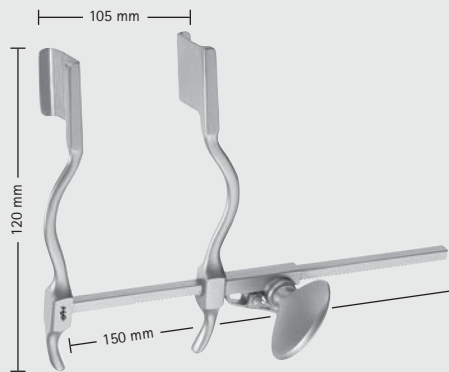

HERTZLER

BV512R

Blätter 20 x 25 mm

Blades 20 x 25 mm

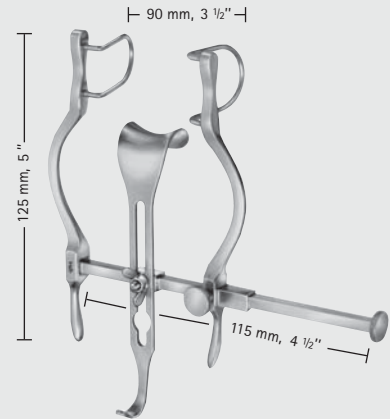

BALFOUR-BABY

BV601R

Seitl. Blätter 27 mm tief

Mittelblatt BV602R 21 x 24 mm

Lateral blades 27 mm deep

Center blade BV602R 21 x 24 mm

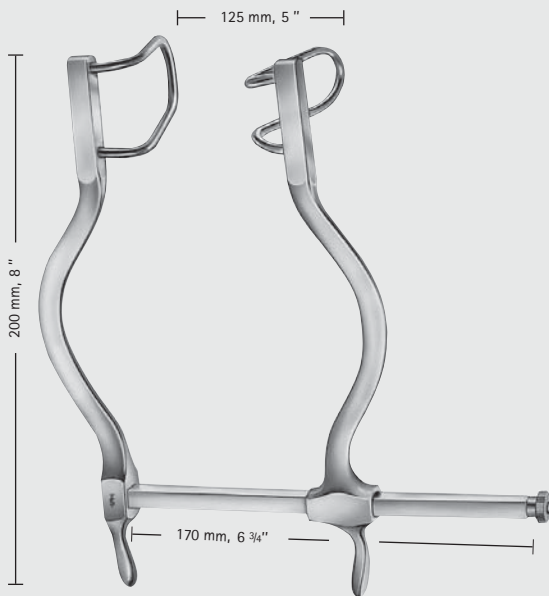

GOSSET

BV502R

Blätter: 55 mm tief

Blades: 55 mm deep

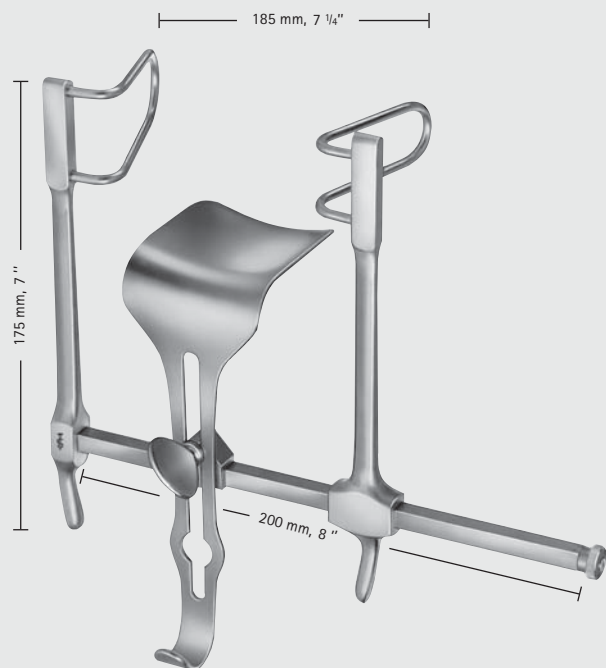

GOSSET

BV505R

Seitl. Blätter 58 mm tief

Mittelblatt BV506R 59 x 57 mm

Lateral blades 58 mm deep

Center blade BV506R 59 x 57 mm



MILLIMETERS

Wundspreizer, Bauchdeckenhalter – Self-Retaining Retractors, Abdominal Retractors

Bauchdeckenhalter

Abdominal Retractors

BV

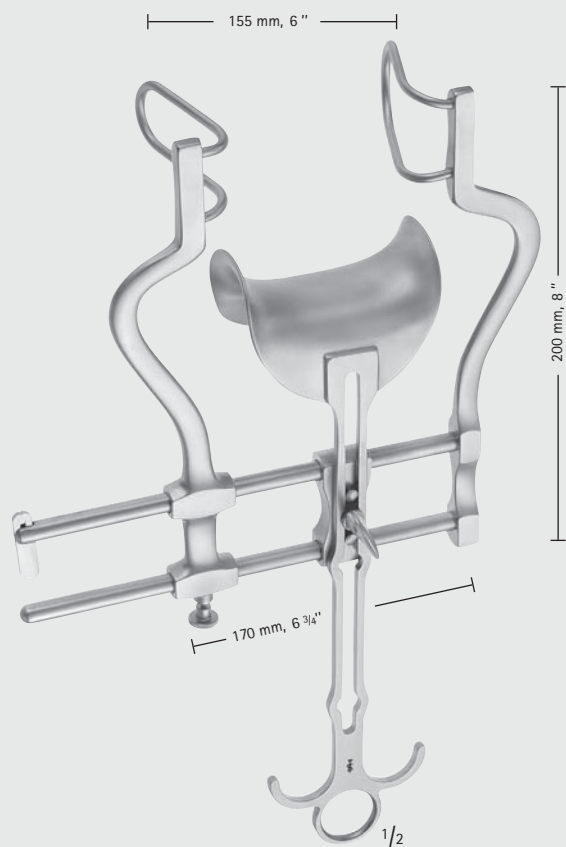

BALFOUR

BV605R

Seitl. Blätter	60 mm tief
Mittelblatt	BV606R 47 x 80 mm
Lateral blade	60 mm deep
Center blade	BV606R 47 x 80 mm

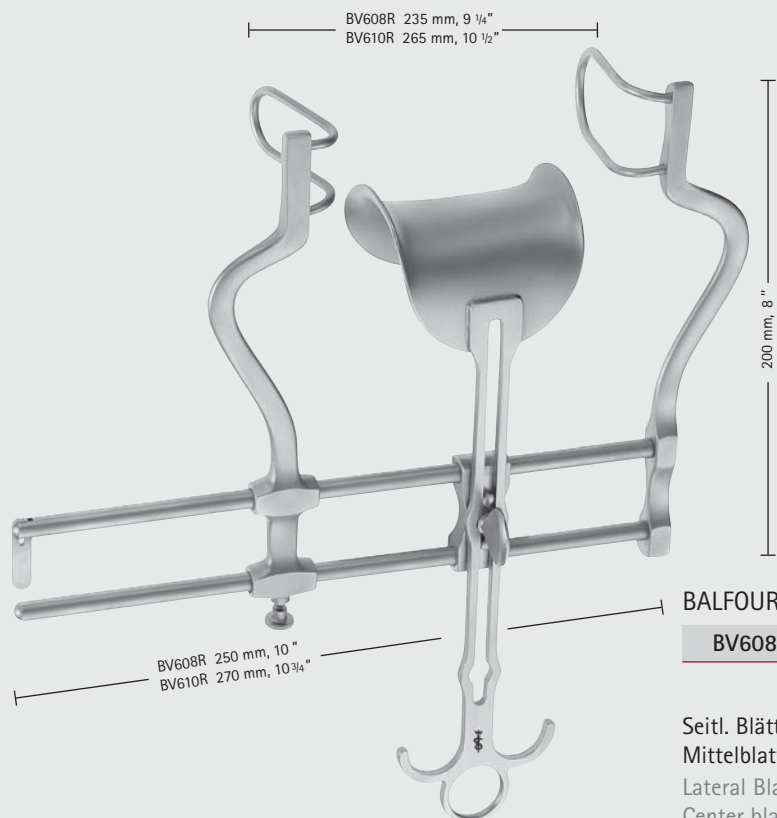

BALFOUR

BV608R-BV610R

	BV608R	BV610R
Seitl. Blätter	60 mm tief	90 mm tief
Mittelblatt	BV609R 62 x 76 mm	BV611R 80 x 80 mm
Lateral Blades	60 mm deep	90 mm deep
Center blade	BV609R 62 x 76 mm	BV611R 80 x 80 mm

INCHES



Wundspreizer, Bauchdeckenhalter – Self-Retaining Retractors, Abdominal Retractors

Bauchdeckenhalter
Abdominal Retractors

BV

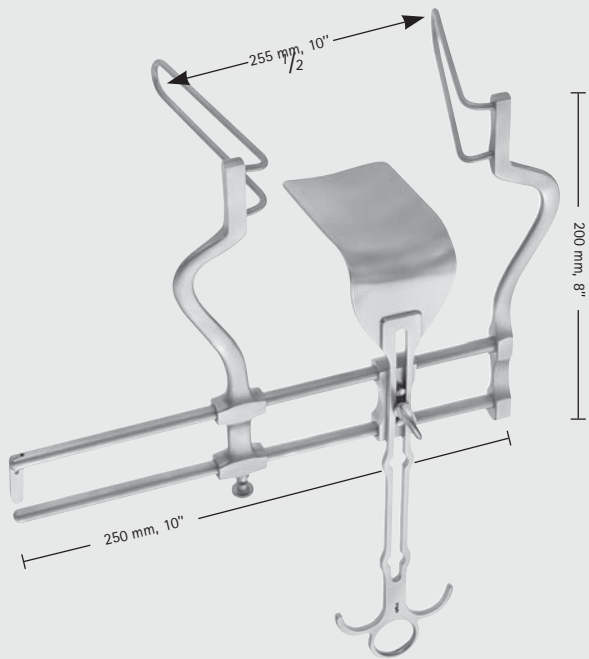

BALFOUR

BV615R

- Seitl. Blätter 105 mm tief
- Mittelblatt BV616R 107 x 59 mm
- Lateral blades 105 mm deep
- Center blade BV616R 107 x 59 mm

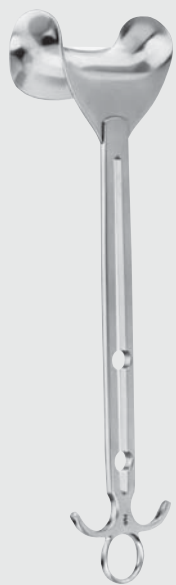

BALFOUR

BV617R

- Mittelblatt allein
- Center blade only
- 54 x 80 mm



BV618R

- Mittelblatt, geschlitzt
- zur retropubischen Prostatektomie
- Center blade, slotted
- for retropubic prostatectomy
- 75 x 80 mm

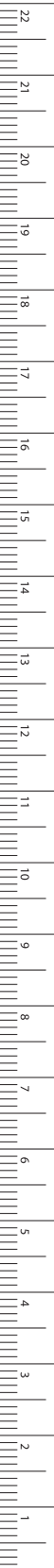

MILLIMETERS

Wundspreizer, Bauchdeckenhalter – Self-Retaining Retractors, Abdominal Retractors

Bauchdeckenhalter

Abdominal Retractors



KUGELSCHNELLVERSCHLUSS
BALL SNAP CLOSURE

Bestelleinheit der Blätter: PAA = Paar

Sales unit of blades: PAA = pair

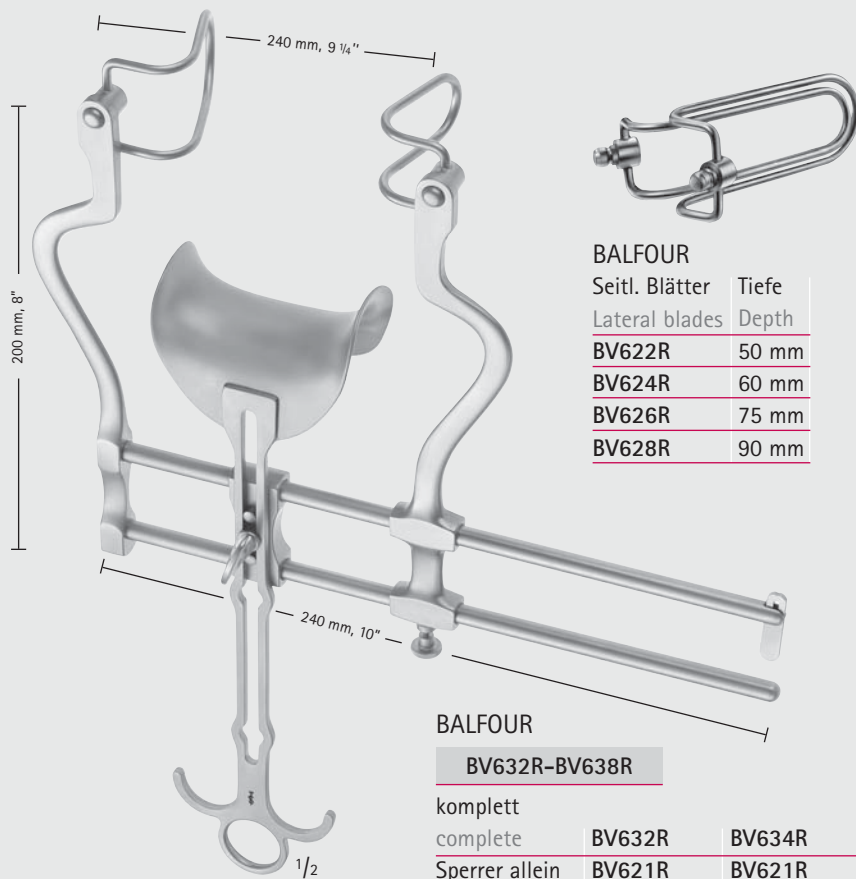

BALFOUR

Seitl. Blätter Lateral blades	Tiefe Depth
BV622R	50 mm
BV624R	60 mm
BV626R	75 mm
BV628R	90 mm

BALFOUR

BV632R-BV638R

komplett

complete	BV632R	BV634R	BV636R	BV638R
Sperrer allein Spreader only	BV621R	BV621R	BV621R	BV621R
Seitl. Blätter Lateral blades	BV622R 50 mm	BV624R 60 mm	BV626R 75 mm	BV628R 90 mm
Mittelblatt Center blade	BV606R 47 x 80 mm	BV609R 62 x 76 mm	BV611R 80 x 80 mm	BV611R 80 x 80 mm

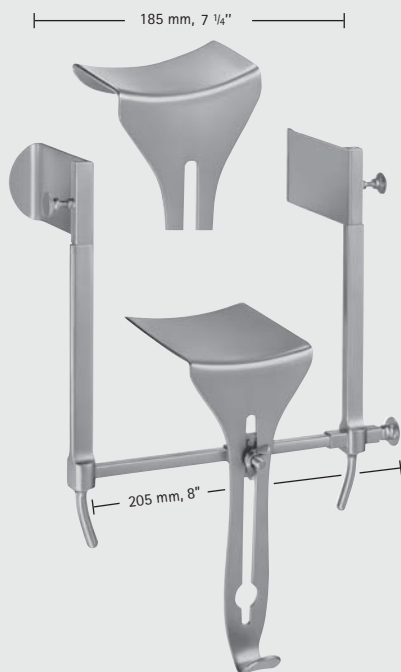

GOLIGHER

BV640R

Bauchdeckenhalter komplett,
bestehend aus:

- Mittelblatt 51 mm tief
- Mittelblatt 102 mm tief
- Seitl. Blätter (Paar) 51 mm tief
- Seitl. Blätter (Paar) 102 mm tief

Abdominal retractor complete,
consisting of:

- Center blade 51 mm deep
- Center blade 102 mm deep
- Lateral blades (pair) 51 mm deep
- Lateral blades (pair) 102 mm deep

Wundspreizer, Bauchdeckenhalter – Self-Retaining Retractors, Abdominal Retractors

Bauchdeckenhalter

Abdominal Retractors

Bauchdeckenhalter für Säuglinge und Kinder

Abdominal retractors for new-born and children

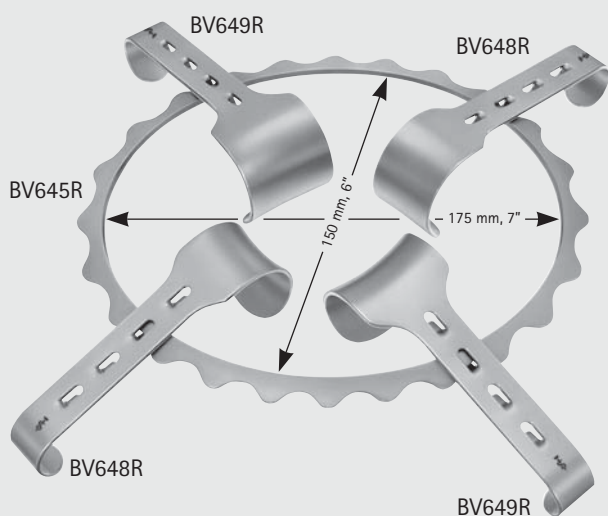

DENIS-BROWNE

BV650R

Bauchdeckenhalter komplett,
bestehend aus:

- BV645R 1 Rahmen 175 x 150 mm
- BV648R 2 Blätter allein 40 x 30 mm
- BV649R 2 Blätter allein 40 x 40 mm

Abdominal retractor complete,
consisting of:

- BV645R 1 frame 175 x 150 mm
- BV648R 2 blades only 40 x 30 mm
- BV649R 2 blades only 40 x 40 mm



DENIS-BROWNE

BV646R

Blatt allein
Blade only
20 x 30 mm



DENIS-BROWNE

BV647R

Blatt allein
Blade only
20 x 40 mm



Wundspreizer, Bauchdeckenhalter – Self-Retaining Retractors, Abdominal Retractors

Bauchdeckenhalter
Abdominal Retractors

Bauchdeckenhalter für Gynäkologen gut geeignet
Abdominal retractors well suitable for gynaecologists

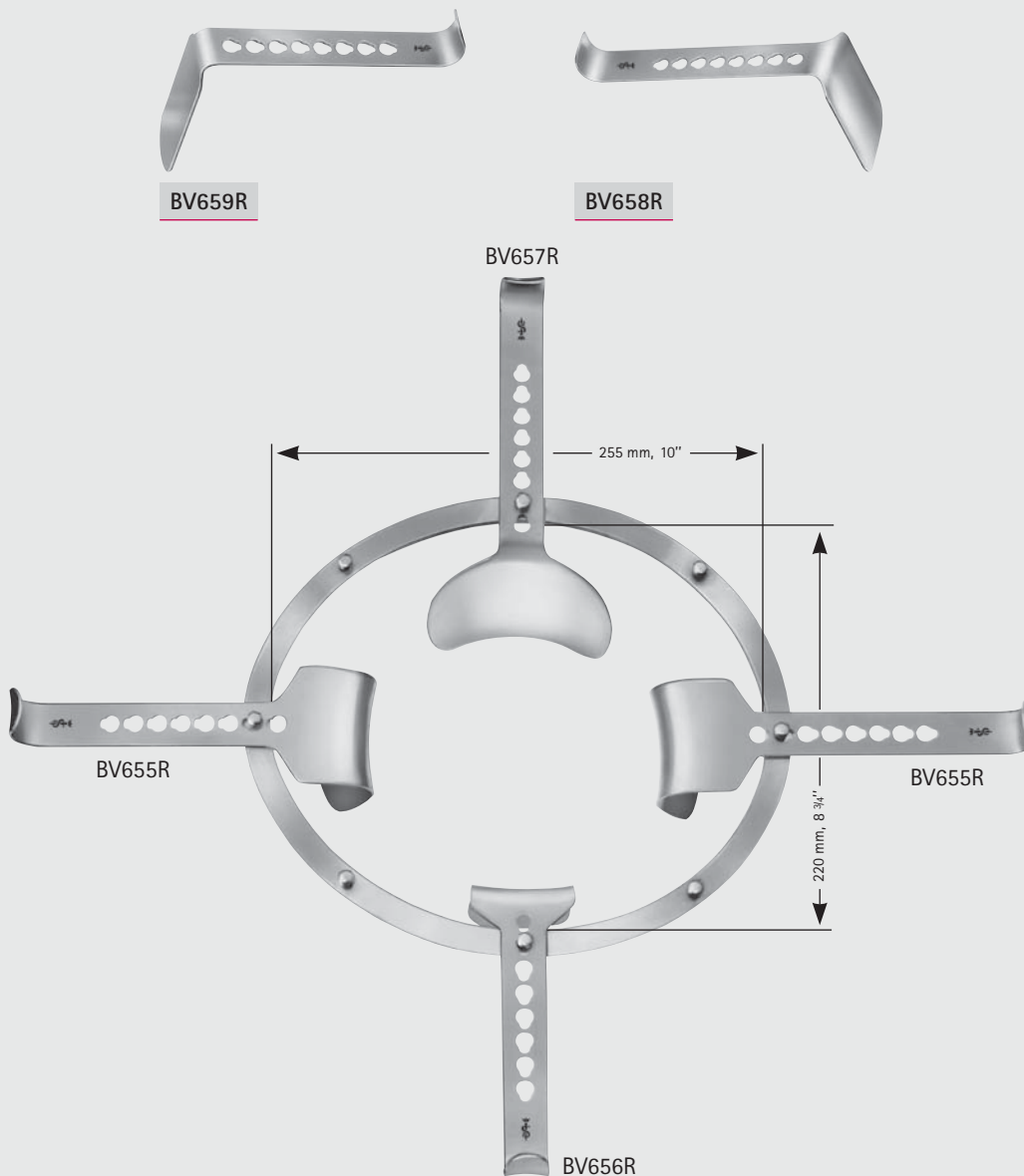

SEMM

BV654R

Bauchdeckenhalter komplett,
bestehend aus:

- BV653R 1 Rahmen 255 x 220 mm
- BV655R 2 Blätter 46 x 64 mm
- BV656R 1 Blatt 53 x 54 mm (für die Blase)
- BV657R 1 Blatt 82 x 97 mm (für den Darm)
- BV658R 1 Blatt 98 x 51 mm (für den Darm)
- BV659R 1 Blatt schmal 107 x 36 mm

Abdominal retractor complete,
consisting of:

- BV653R 1 frame 255 x 220 mm
- BV655R 2 blades 46 x 64 mm
- BV656R 1 blade 53 x 54 mm (for bladder)
- BV657R 1 blade 82 x 97 mm (for intestine)
- BV658R 1 blade 98 x 51 mm (for intestine)
- BV659R 1 blade narrow 107 x 36 mm

BV

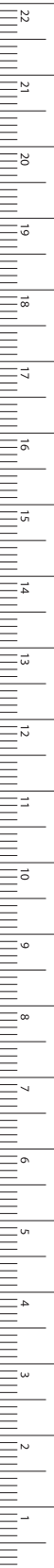

MILLIMETERS

Wundspreizer, Bauchdeckenhalter – Self-Retaining Retractors, Abdominal Retractors

Bauchdeckenhalter

Abdominal Retractors

BV



250 x 250 mm, 10 x 10"

KIRSCHNER

BV662R

Bauchdeckenhalter komplett, bestehend aus:

- BV663R 1 Rahmen, zusammenlegbar
- BV668R 2 Blätter
- BV669R 2 Blätter

Abdominal retractor complete, consisting of:

- BV663R 1 Holding frame
- BV668R 2 Blades
- BV669R 2 Blades

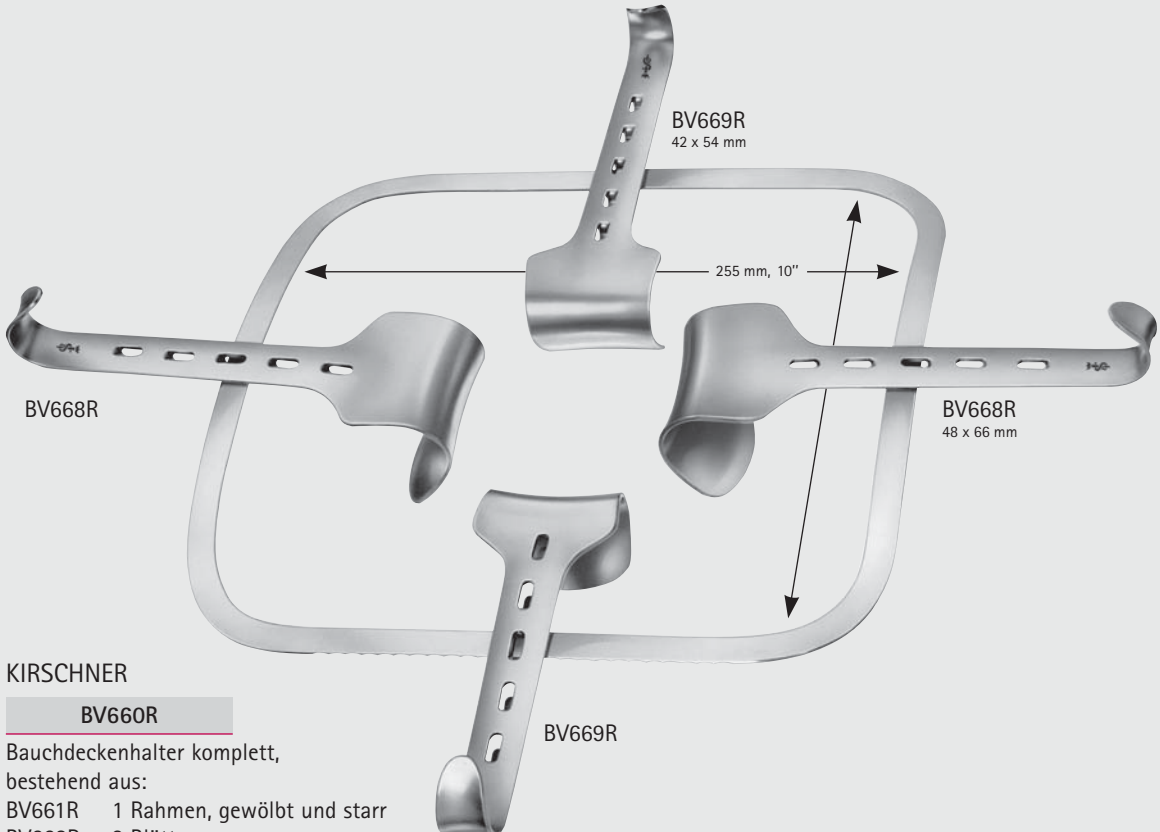

BV669R
42 x 54 mm

255 mm, 10"

BV668R

BV668R
48 x 66 mm

BV669R

KIRSCHNER

BV660R

Bauchdeckenhalter komplett, bestehend aus:

- BV661R 1 Rahmen, gewölbt und starr
- BV668R 2 Blätter
- BV669R 2 Blätter

Abdominal retractor complete, consisting of:

- BV661R 1 Vaulted fixed frame
- BV668R 2 Blades
- BV669R 2 Blades

KIRSCHNER

BV664R

Rahmen allein, übergroß
Frame only, over-sized
275 x 355 mm

KIRSCHNER

BV665R

Rahmen allein
Frame only
295 x 275 mm

INCHES



Wundspreizer, Bauchdeckenhalter – Self-Retaining Retractors, Abdominal Retractors

Bauchdeckenhalter
Abdominal Retractors

Zusätzliche Blätter für Fettleibige
Additional valves for corpulent persons

BV



KIRSCHNER

BV670R

64 x 80 mm



KIRSCHNER-BALFOUR

BV672R

80 x 82 mm

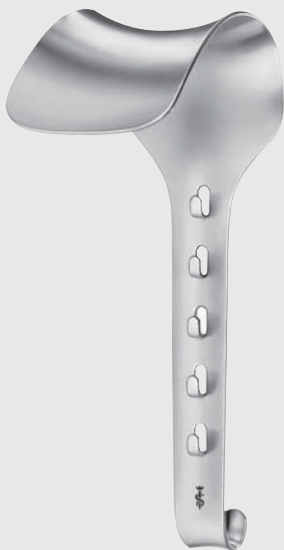

KIRSCHNER

BV674R 90 x 69 mm

BV675R 95 x 95 mm

BV676R 78 x 58 mm



KIRSCHNER

BV680R 108 x 42 mm

BV682R 91 x 55 mm

BV684R 120 x 55 mm



MILLIMETERS

MUENSTER Retractor Blade

BV957R



MUENSTER Retractor Blade, malleable, depth: 220 mm, width: 85 mm, non-sterile, reusable

Product search type: Retractor Blade

Author: MUENSTER

Aesculap Product Groups: General Surgical Instruments

Altern. Productname: Abdominal Spatula

Shape / Form: malleable

Width (mm): 85.000 mm

Depth (mm): 220.000 mm

To be used with (code):

BV836RBV840RBV834RBV826RBV839RBV833RBV828RBV825R

Discipline: General Surgery, Gynaecology, Urology, Vascular Surgery

Indication: Abdominal

Surgical Step: Retraction

Type of Sterilization: not sterilized ex works

Data Matrix: Yes

Disposable / Reusable: reusable

Sterility: non-sterile

Product contains Latex: No



Wundspreizer, Bauchdeckenhalter – Self-Retaining Retractors, Abdominal Retractors

Bauchdeckenhalter
Abdominal Retractors

BV



O' SULLIVAN-O' CONNOR

US100

Bauchdeckenhalter komplett,
bestehend aus:

- US100 1 Bauchdeckenhalter
- US100201 2 Blätter
- US100202 1 Blatt

Abdominal retractor complete,
consisting of:

- US100 1 Retractor
- US100201 2 Blades
- US100202 1 Blade



O'SULLIVAN-O' CONNOER

US100201

kleines Blatt
small blade



O'SULLIVAN-O' CONNOER

US100202

großes Blatt
large blade



MILLIMETERS

Wundhaken – Wound Retractors

Nerv- und Gefäßhäkchen

Nerve- and Vessel Hooks

BT

Maßangaben für Blattgrößen der Wundhaken

1. Zahl = Tiefe Beispiel: 25 x 38 mm

2. Zahl = Breite

Dimensions for blade size of retractors

1st number = depth Example: 25 x 38 mm

2nd number = width

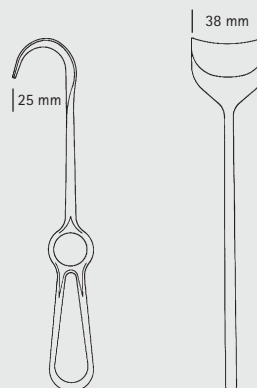

WAGENER

OF282R-OF285R

150 mm, 6"

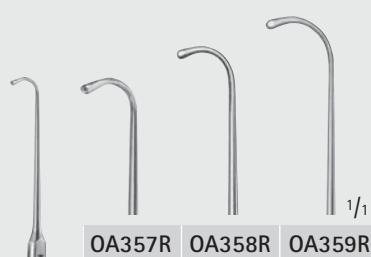

GRAEFE

OA357R-OA359R

140 mm, 5 1/2"



ST. BARTS

OF288R

Ohrhäkchen, stumpf
Hook, blunt
180 mm, 7"



Wundhaken – Wound Retractors

Nerv- und Gefäßhäkchen
Nerve- and Vessel Hooks

BT



BROM

BT075R

Venenhäkchen
Vein hook
170 mm, 6 3/4"



CRILE

BT080R

200 mm, 8"



CUSHING

BT082R–BT083R

190 mm, 7 1/2"

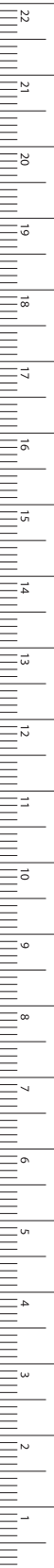

MILLIMETERS

Wundhaken – Wound Retractors

Feine Wundhäkchen (Dura- und Hauthäkchen)

Fine Wound Retractors (Dura- and Skin Retractors)

Maßangaben für Blattgrößen der Wundhaken

1. Zahl = Tiefe Beispiel: 25 x 38 mm

2. Zahl = Breite

Dimensions for blade size of retractors

1st number = depth Example: 25 x 38 mm

2nd number = width

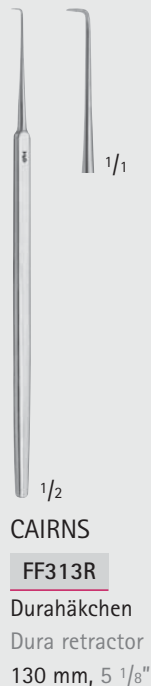
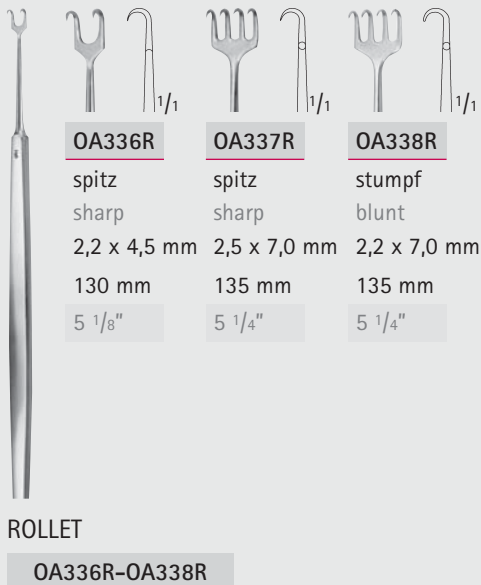
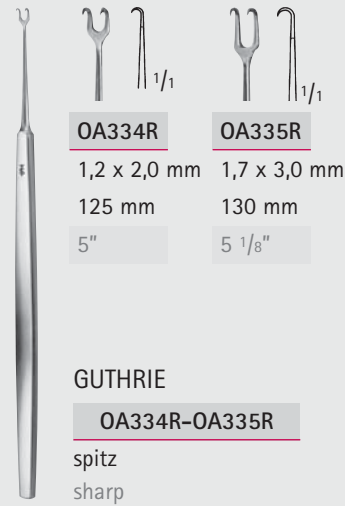
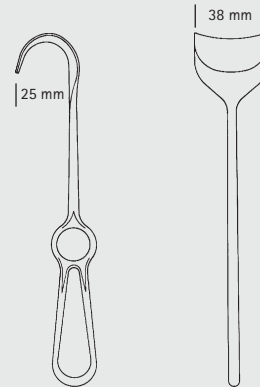

BT



INCHES



Wundhaken – Wound Retractors

Feine Wundhäkchen (Dura- und Hauthäkchen)
Fine Wound Retractors (Dura- and Skin Retractors)

BT



KILNER

OL610R

160 mm, 6 1/4"



MC INDOE

OL615R-OL616R

150 mm, 6"



FREER

OL621R

150 mm, 6"



MÜLLER

OL626R

150 mm, 6"



MÜLLER

OL627R

150 mm, 6"



COTTLE

OL617R

160 mm, 6 1/4"



COTTLE

OL619R

160 mm, 6 1/4"

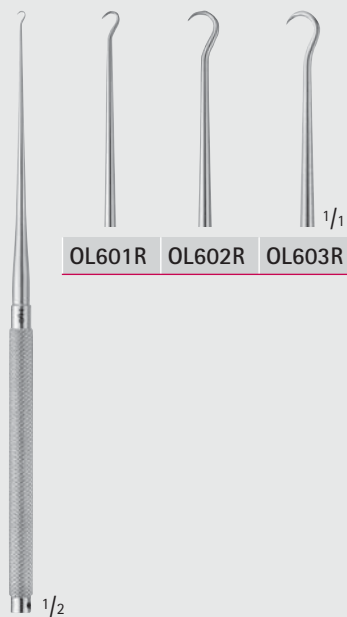

KLEINERT-KUTZ

OL601R-OL603R

160 mm, 6 3/8"



MILLIMETERS

Wundhaken – Wound Retractors

Feine Wundhäkchen (Dura- und Hauthäkchen)

Fine Wound Retractors (Dura- and Skin Retractors)

Maßangaben für Blattgrößen der Wundhaken

1. Zahl = Tiefe Beispiel: 25 x 38 mm

2. Zahl = Breite

Dimensions for blade size of retractors

1st number = depth Example: 25 x 38 mm

2nd number = width

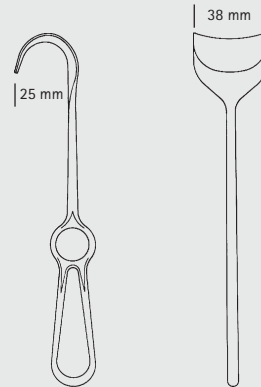

BT

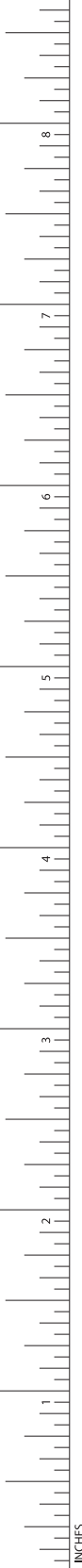

JÄGER

OA351R

135 mm, 5 1/4"

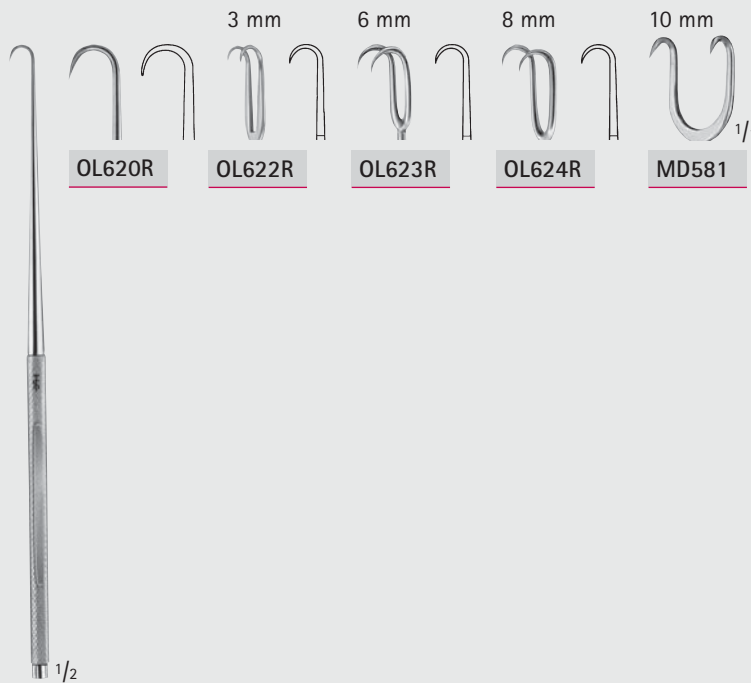

JOSEPH

OL620R-MD581R

165 mm, 6 1/2"



GILLIES

OL611R-OL612R

180 mm, 7"



Wundhaken – Wound Retractors

Wundhaken mit Treangle-Griff
Retractors with Treangle Handle

BT

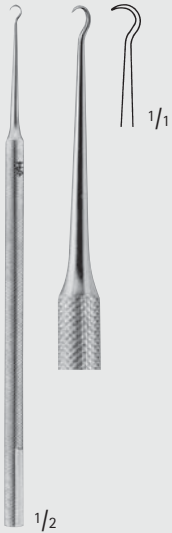
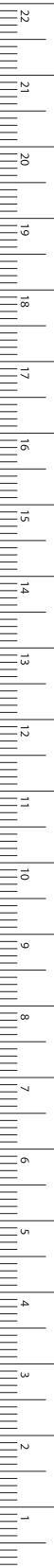

MANNERFELT MODIF.

BT901R

scharf
sharp
135 mm, 5 1/4"



MANNERFELT MODIF.

BT902R

scharf
sharp
155 mm, 6"



MANNERFELT MODIF.

BT904R

scharf
sharp
155 mm, 6"



BT906R

8,0 x 12,5 mm

BT908R

10,2 x 21,5 mm

MANNERFELT MODIF.

BT906R–BT908R

Gabelhaken, retrograd gebogen
Forked hooks, retrograd curved
155 mm, 6"



BT911R

BT912R

5,0 x 4,0 mm

BT913R

5,5 x 7,2 mm

MANNERFELT MODIF.

BT911R–BT913R

enge Biegung, scharf
small curve, sharp
155 mm, 6"



BT916R

BT917R

5,5 x 4,0 mm

BT918R

5,5 x 7,2 mm

MANNERFELT MODIF.

BT916R–BT918R

enge Biegung, stumpf
small curve, blunt
155 mm, 6"



BT921R

BT922R

8,0 x 8,0 mm

BT923R

7,0 x 11,0 mm

MANNERFELT MODIF.

BT921R–BT923R

weite Biegung, scharf
large curve, sharp
155 mm, 6"



BT926R

BT927R

7,0 x 8,0 mm

BT928R

7,0 x 11,0 mm

MANNERFELT MODIF.

BT926R–BT928R

weite Biegung, stumpf
large curve, blunt
155 mm, 6"

MILLIMETERS

Wundhaken – Wound Retractors

Wundhaken mit Treangle Griff

Retractors with Treangle Handle

Maßangaben für Blattgrößen der Wundhaken

1. Zahl = Tiefe Beispiel: 25 x 38 mm

2. Zahl = Breite

Dimensions for blade size of retractors

1st number = depth Example: 25 x 38 mm

2nd number = width

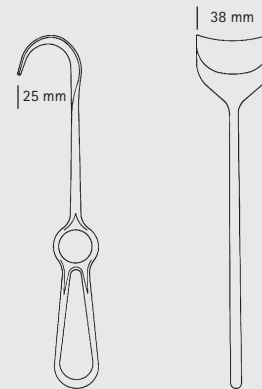

BT



MANNERFELT MODIF.

BT933R

flexibler Schaft,
enge Biegung, scharf
flexible shaft,
small curve, sharp
155 mm, 6"



MANNERFELT MODIF.

BT940R

hohlgekehlt
hollow grooved
155 mm, 6"



BT943R

15 x 6 mm



BT944R

20 x 6 mm



BT945R

25 x 6 mm



BT946R

30 x 8 mm

LANGENBECK-MANNERFELT MODIF.

BT943R-BT946R

155 mm, 6"



Wundhaken – Wound Retractors
Wundhaken mit Treangle-Griff
Retractors with Treangle Handle

BT

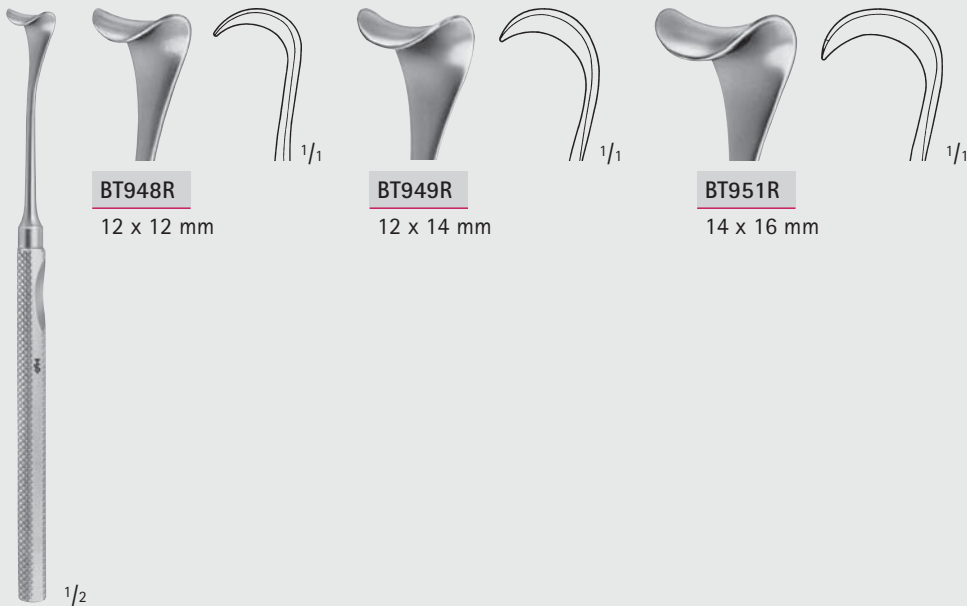

BT948R

12 x 12 mm

BT949R

12 x 14 mm

BT951R

14 x 16 mm

MANNERFELT MODIF.

BT948R-BT951R

Sattelhaken

Saddle hooks

155 mm, 6"



12 x 12 mm

MANNERFELT MODIF.

BT958R

Sattelhaken, gefenstert

Saddle hook, fenestrated

155 mm, 6"

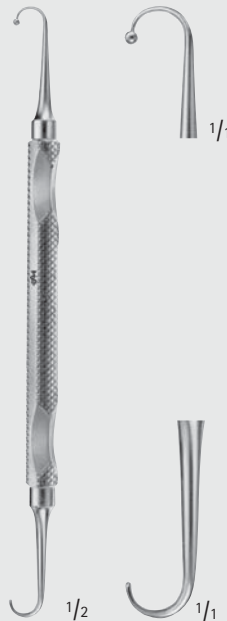

MANNERFELT MODIF.

BT964R

Sehnen-Doppelhaken

Tendon double hook

160 mm, 6 1/4"

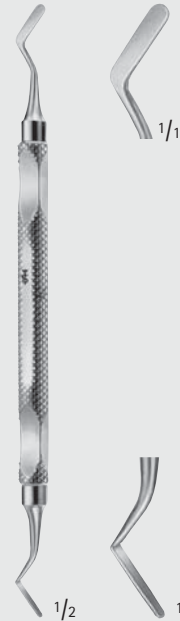

MANNERFELT MODIF.

BT966R

Doppelspatel

Spatula, double-ended

160 mm, 6 1/4"

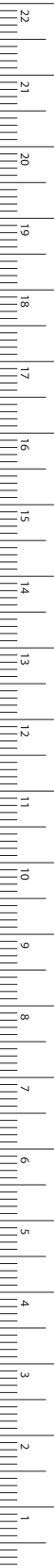

MILLIMETERS

Wundhaken – Wound Retractors

Wundhaken

Retractors

Maßangaben für Blattgrößen der Wundhaken

1. Zahl = Tiefe Beispiel: 25 x 38 mm

2. Zahl = Breite

Dimensions for blade size of retractors

1st number = depth Example: 25 x 38 mm

2nd number = width

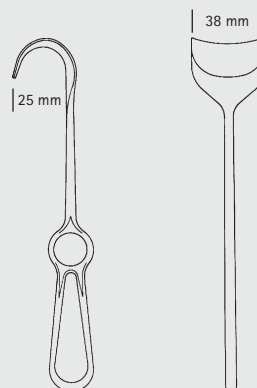

BT



FOMON

OL202R

145 mm, 5 3/4"



BT173R

BT174R

BT173R-BT174R

160 mm, 6 1/4"



BT177R

BT178R

LANGENBECK-GREEN

BT177R-BT178R

160 mm, 6 1/4"

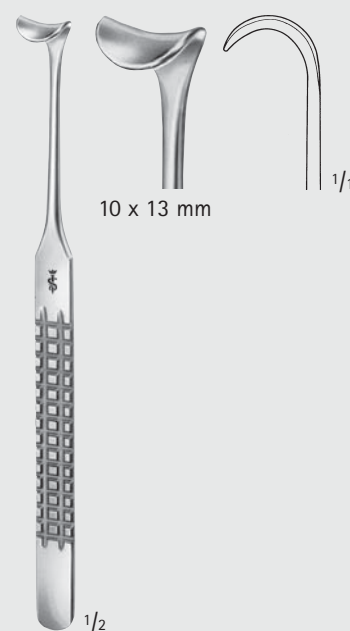

10 x 13 mm

BT179R

160 mm, 6 1/4"



Wundhaken – Wound Retractors

Wundhaken Retractors

BT

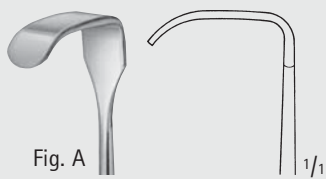

Fig. A

BT193R

18 x 7 mm



Fig. B

BT194R

16 x 5 mm

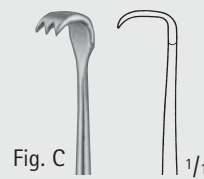

Fig. C

BT195R

7 x 4 mm



Fig. D

BT196R

5 x 10 mm



Fig. E

BT197R

11 x 4 mm



Fig. F

BT198R

6 x 4 mm



¹/₂

MEYERDING

BT193R-BT198R

Fig. A - Fig. F
180 mm, 7"

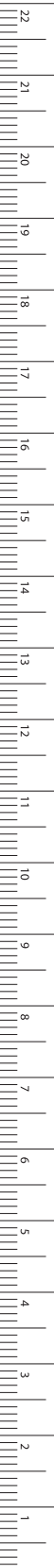

MILLIMETERS

Wundhaken – Wound Retractors

Wundhaken

Retractors

Maßangaben für Blattgrößen der Wundhaken

1. Zahl = Tiefe Beispiel: 25 x 38 mm

2. Zahl = Breite

Dimensions for blade size of retractors

1st number = depth Example: 25 x 38 mm

2nd number = width



EMMET

BT161R

Fistelhaken

Fistula hook

220 mm, 8 3/4"



SIMON

BT166R

Fistelhaken

Fistula hook



SIMON

BT167R

Fistelhaken

Fistula hook

220 mm, 8 3/4"



LANGE

OL201R

Fistelhaken

Fistula hook

235 mm, 9"

BT





Wundhaken – Wound Retractors

Wundhaken
Wound Retractors

BT

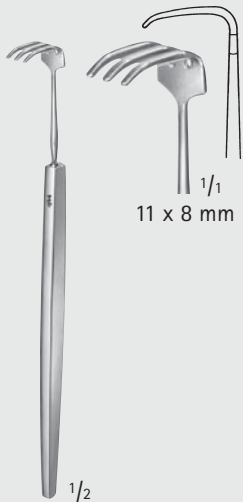

11 x 8 mm

1/2

PAUL

OA340R

Sehnenscheidenhaken

Tendon hook

120 mm, 4 3/4"



BT170R

12 x 6 mm

BT171R

12 x 11 mm

1/2

BT170R-BT171R

Sehnenscheidenhaken

Tendon hooks

175 mm, 7"

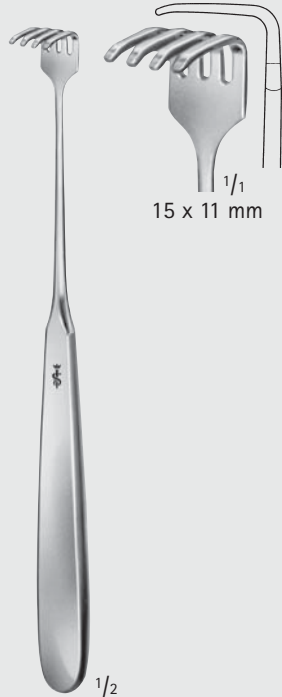

15 x 11 mm

1/2

KLAPP

BT172R

Sehnenscheidenhaken

Tendon hook

175 mm, 7"



BT180R

15 x 6 mm

stumpf

blunt

BT181R

15 x 6 mm

gezahnt

toothed

1/2

STRANDELL-STILLE

BT180R-BT181R

Sehnenscheidenhaken

Tendon hooks

180 mm, 7"



6 x 12 mm

1/2

MASING

OL211R

140 mm, 5 1/2"



10 x 12 mm

1/2

COTTLE

OL212R

140 mm, 5 1/2"

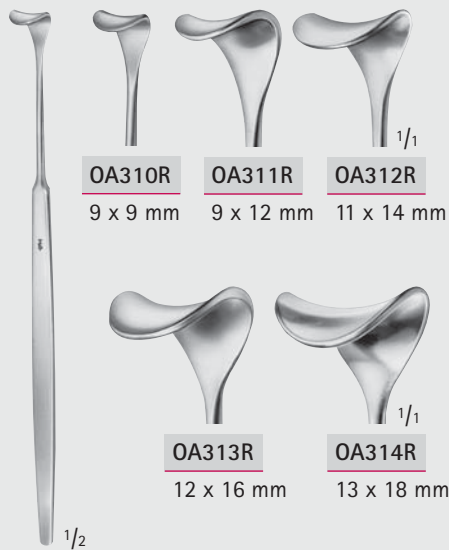

OA310R

9 x 9 mm

OA311R

9 x 12 mm

OA312R

11 x 14 mm

OA313R

12 x 16 mm

OA314R

13 x 18 mm

1/2

DESMARRES

OA310R-OA314R

140 mm, 5 1/2"



MILLIMETERS

Wundhaken – Wound Retractors

Wund- und Venenhaken

Wound- and Vein Retractors

Maßangaben für Blattgrößen der Wundhaken

1. Zahl = Tiefe Beispiel: 25 x 38 mm

2. Zahl = Breite

Dimensions for blade size of retractors

1st number = depth Example: 25 x 38 mm

2nd number = width

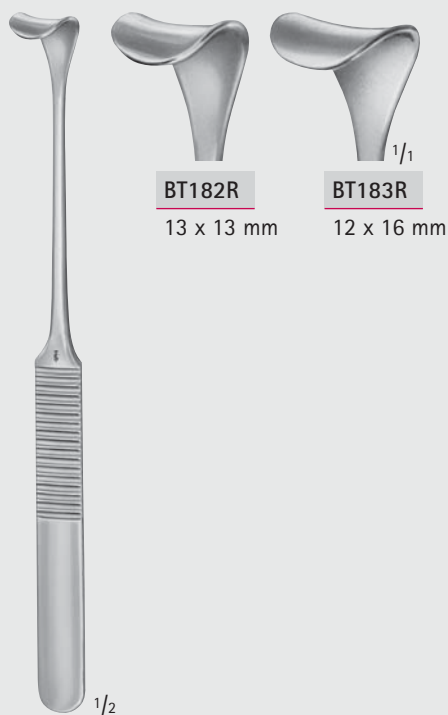
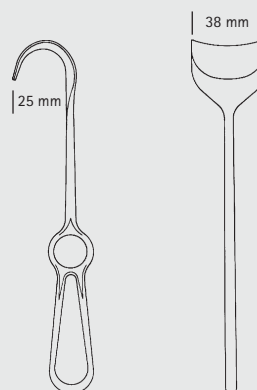

BT182R

13 x 13 mm

BT183R

12 x 16 mm

KÖNIG

BT182R-BT183R

180 mm, 7"



BT190R

10 x 10 mm

CUSHING-KOCHER

BT190R

175 mm, 7"

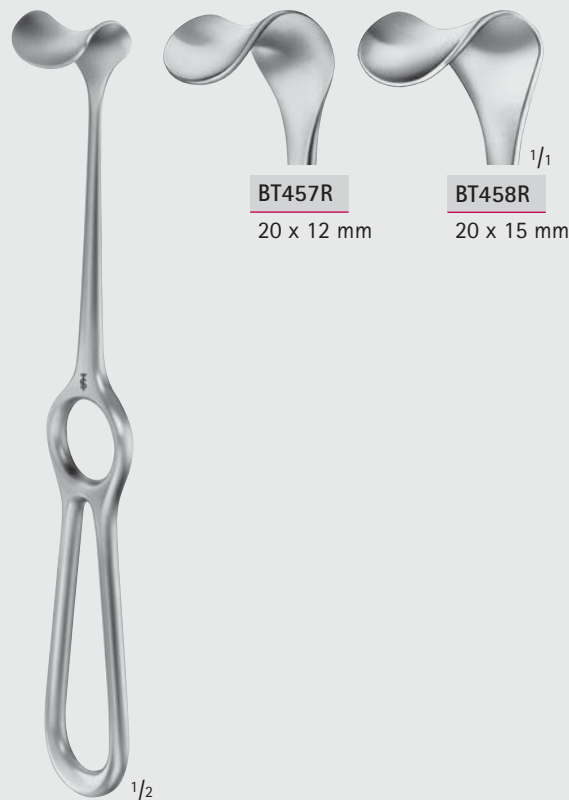

BT457R

20 x 12 mm

BT458R

20 x 15 mm

KOCHER

BT457R-BT458R

205 mm, 8"

BT





Wundhaken – Wound Retractors

Wund- und Venenhaken
Wound- and Vein Retractors

BT

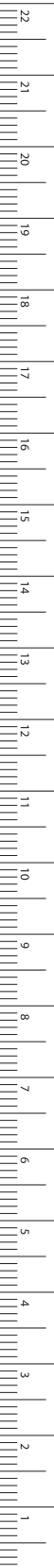

MILLIMETERS



1/1
13 x 6 mm



1/2

SCHOENBORN

BT192R

200 mm, 8"

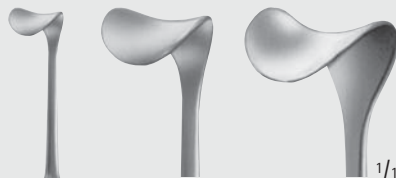

BT184R

10 x 13 mm

BT185R

14 x 18 mm



1/2

CUSHING

BT184R-BT185R

205 mm, 8"

20 x 15 mm



1/2

BT187R

205 mm, 8"

20 x 19 mm

Wundhaken – Wound Retractors

Wund- und Venenhaken

Wound- and Vein Retractors

Maßangaben für Blattgrößen der Wundhaken

1. Zahl = Tiefe Beispiel: 25 x 38 mm

2. Zahl = Breite

Dimensions for blade size of retractors

1st number = depth Example: 25 x 38 mm

2nd number = width

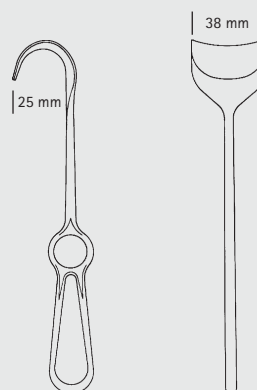

CUSHING

BT200R-BT202R

250 mm, 10"



BT206R

Präparationshäkchen
Small dissecting hook
235 mm, 9 1/4"



HESS

FF707R-FF709R

Nervwurzelhaken
Nerve root retractors
175 mm, 7"



Wundhaken – Wound Retractors
Wundhaken
Retractors

BT

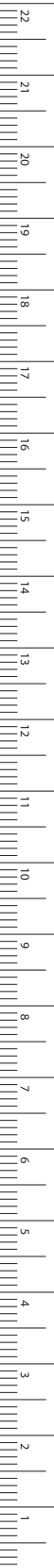

MILLIMETERS

5 x 10 mm

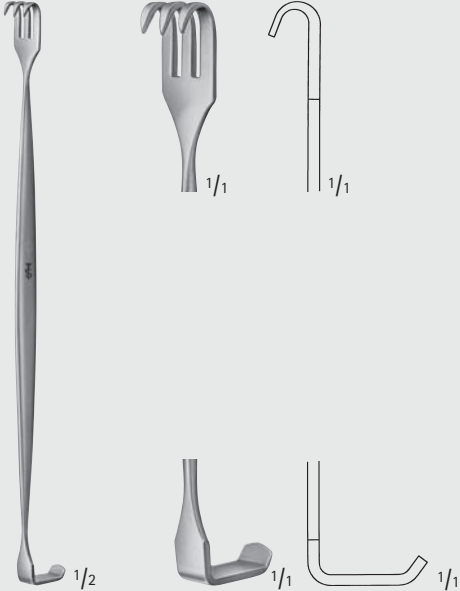

13 x 5 mm

KILNER

BT005R

155 mm, 6"

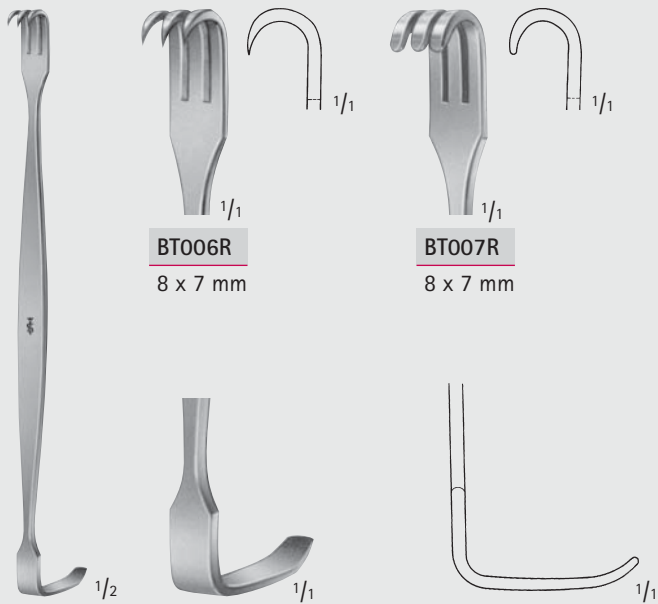

BT006R

8 x 7 mm

BT007R

8 x 7 mm

22 x 7 mm

BABY-SENN-MILLER

BT006R-BT007R

155 mm, 6"

8 x 7 mm

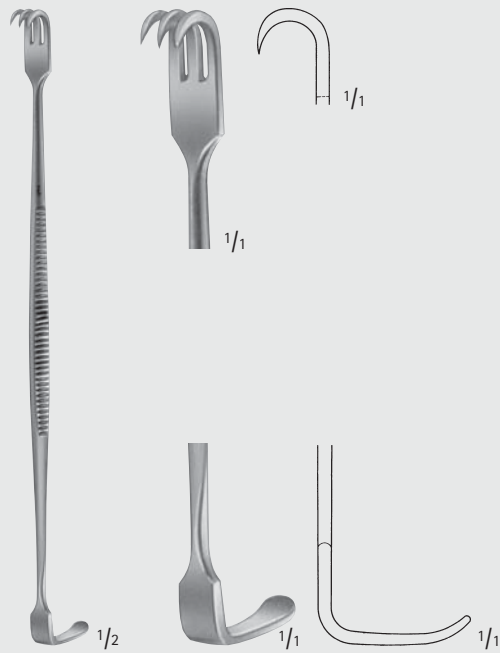

18 x 5,5 mm

SENN-MILLER

BT008R

165 mm, 6 1/2"

Wundhaken – Wound Retractors

Wundhaken

Retractors

Maßangaben für Blattgrößen der Wundhaken

1. Zahl = Tiefe Beispiel: 25 x 38 mm

2. Zahl = Breite

Dimensions for blade size of retractors

1st number = depth Example: 25 x 38 mm

2nd number = width

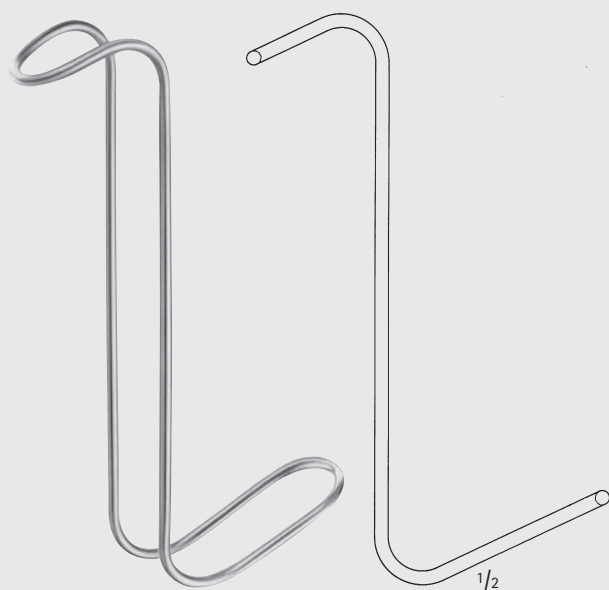
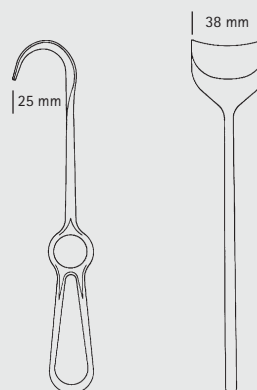

COLLIN-HARTMANN

BT001R

150 mm, 6"



STERNBERG

OM251R	OM252R	OM253R
120 mm	130 mm	135 mm
4 1/4"	5"	5 1/4"

BT



INCHES



Wundhaken – Wound Retractors

Wundhaken Retractors

BT

10 x 8 mm

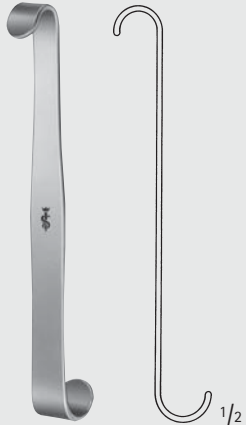

12 x 11 mm

LUER

BT010R

110 mm, 4 3/8"

10 x 12 mm

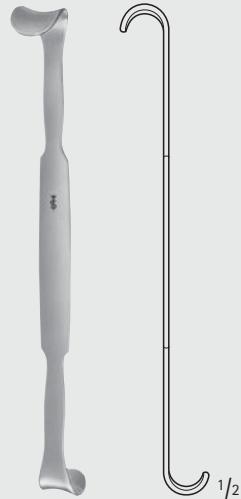

11 x 15 mm

ROSE

BT011R

130 mm, 5 1/8"

17 x 16 mm



18 x 22 mm

BABY-ROUX

BT019R

135 mm, 5 1/4"

22 x 15 mm
18 x 15 mm

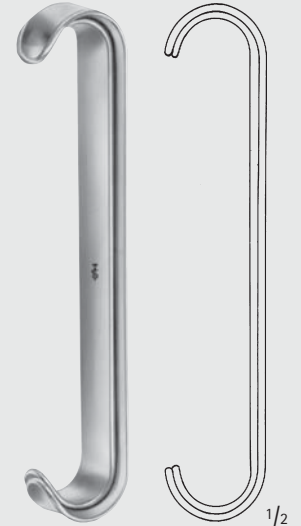

18 x 15 mm
22 x 15 mm

PARKER

BT025R

135 mm, 5 1/4"

5 x 3 mm



14 x 6,3 mm

RAGNELL

BT004R

150 mm, 6"

11 x 4 mm

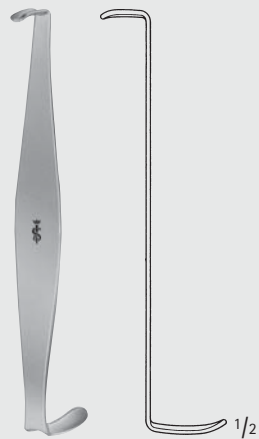

19 x 6 mm

CRILE

BT012R

110 mm, 4 3/8"

25 x 10 mm
22 x 10 mm

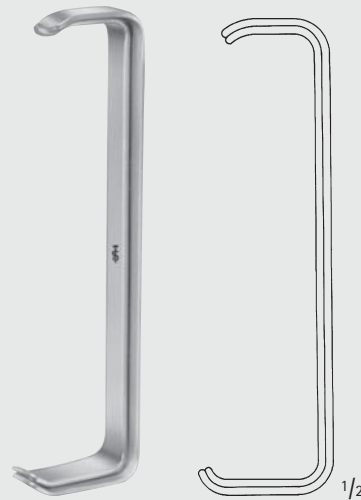

28 x 12 mm
32 x 12 mm

FARABEUF

BT020R

125 mm, 5"

23 x 16 mm
20 x 16 mm

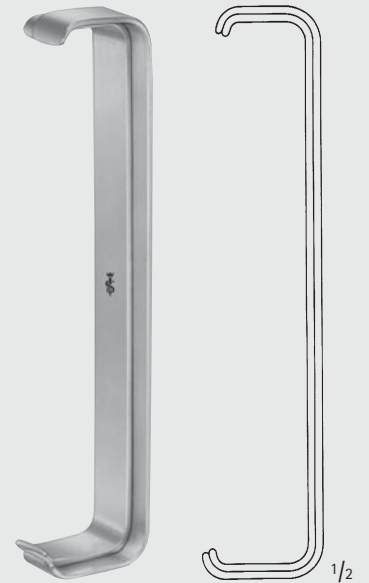

24 x 16 mm
28 x 16 mm

FARABEUF

BT021R

150 mm, 6"

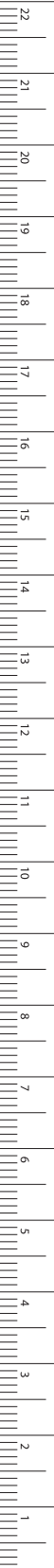

MILLIMETERS

Wundhaken – Wound Retractors

Wundhaken

Retractors

Maßangaben für Blattgrößen der Wundhaken

1. Zahl = Tiefe Beispiel: 25 x 38 mm

2. Zahl = Breite

Dimensions for blade size of retractors

1st number = depth Example: 25 x 38 mm

2nd number = width

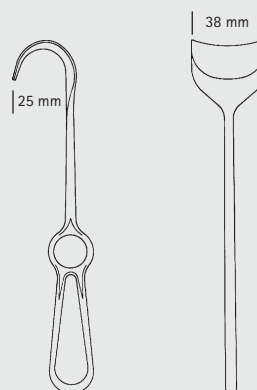

36 x 44 mm

30 x 24 mm



36 x 44 mm

30 x 24 mm

PARKER

BT026R

180 mm, 7"

21 x 14 mm

17 x 14 mm



28 x 16 mm

32 x 16 mm

COLLIN

BT022R

150 mm, 6"

BT



INCHES



Wundhaken – Wound Retractors

Wundhaken
Retractors

BT

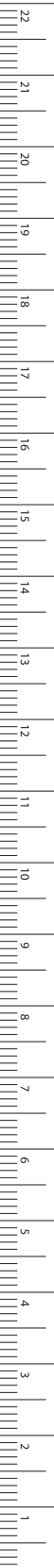

MILLIMETERS



ROUX

BT030R-BT033R

Satz komplett
bestehend aus:

Set complete,
consisting of:

BT031R

BT032R

BT033R

165 mm, 6 1/2"

19 x 22 mm

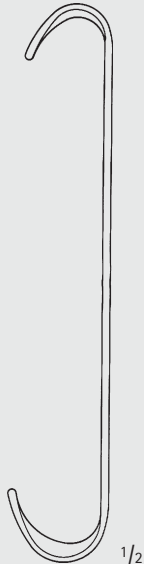

23 x 30 mm

BT031R

25 x 26 mm

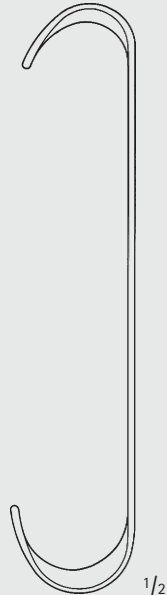

28 x 38 mm

BT032R

28 x 29 mm

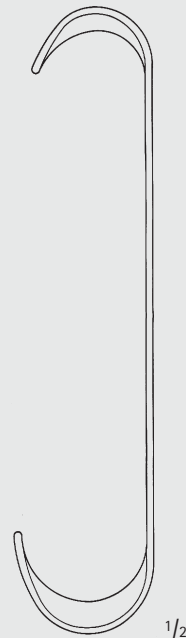

33 x 45 mm

BT033R

Wundhaken – Wound Retractors

Wundhaken

Retractors

Maßangaben für Blattgrößen der Wundhaken

1. Zahl = Tiefe Beispiel: 25 x 38 mm

2. Zahl = Breite

Dimensions for blade size of retractors

1st number = depth Example: 25 x 38 mm

2nd number = width

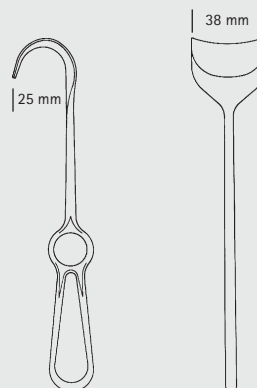

28 x 24 mm

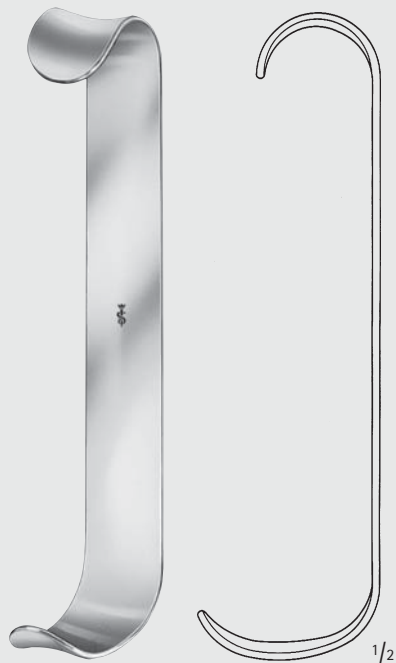

43 x 24 mm

ROUX

BT028R

170 mm, 6 3/4"

28 x 28 mm

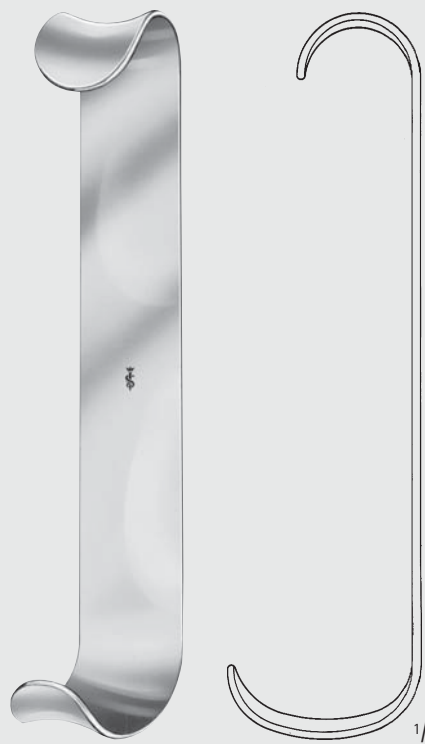

46 x 28 mm

ROUX

BT029R

190 mm, 7 1/2"

BT





Wundhaken – Wound Retractors
Wundhaken
Retractors

BT

30 x 19 mm

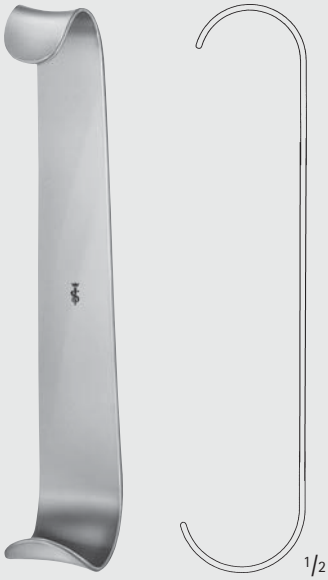

33 x 25 mm

KILNER

OL219R

150 mm, 6"

35 x 29 mm



40 x 35 mm

KILNER

OL220R

150 mm, 6"

20 x 22 mm



25 x 29 mm

ROUX

BT034R

150 mm, 6"

25 x 26 mm

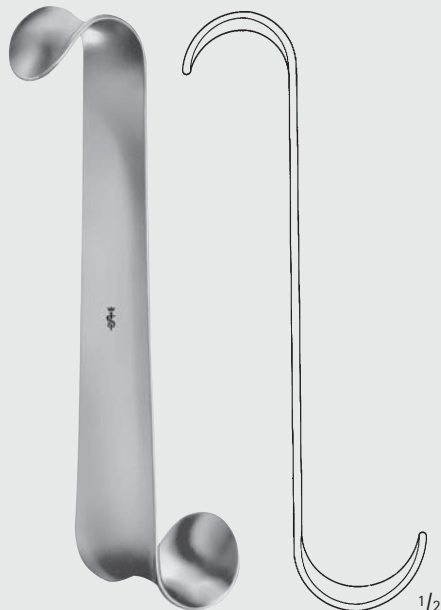

30 x 38 mm

ROUX

BT035R

160 mm, 6 1/4"

28 x 29 mm

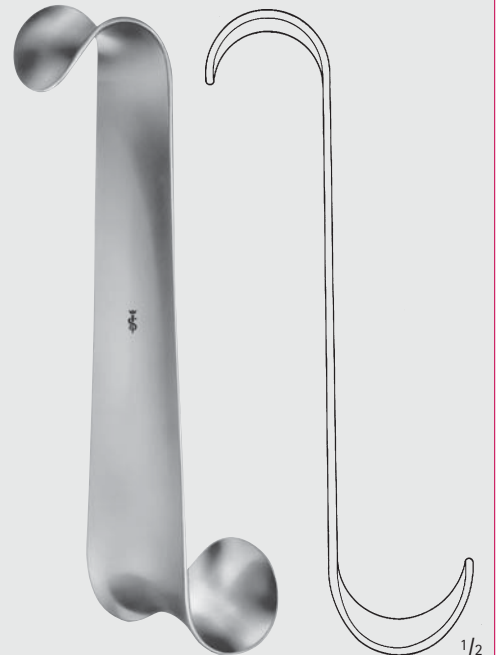

33 x 44 mm

ROUX

BT036R

170 mm, 6 3/4"

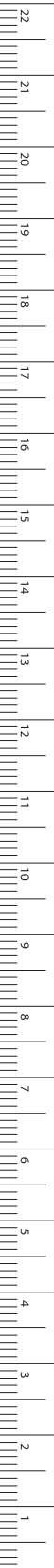

Wundhaken – Wound Retractors

Wundhaken

Retractors

Maßangaben für Blattgrößen der Wundhaken

1. Zahl = Tiefe Beispiel: 25 x 38 mm

2. Zahl = Breite

Dimensions for blade size of retractors

1st number = depth Example: 25 x 38 mm

2nd number = width

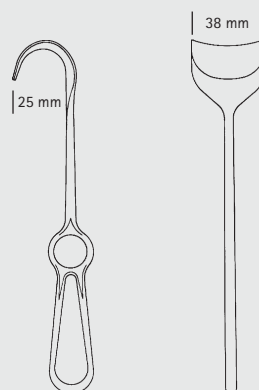

30 x 13 mm

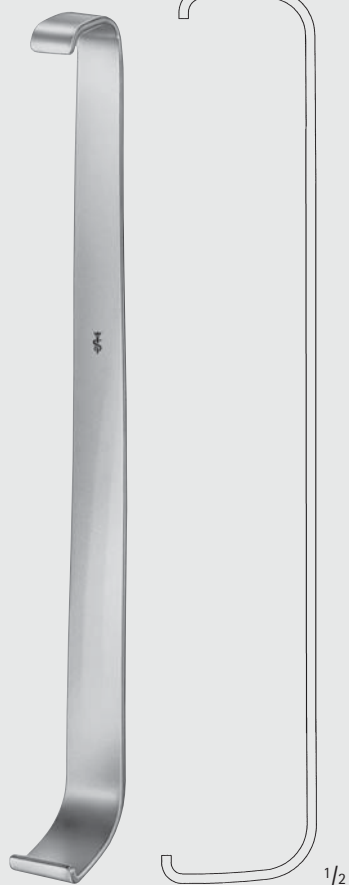

35 x 19 mm

LANE

BT037R

230 mm, 9"

30 x 25 mm

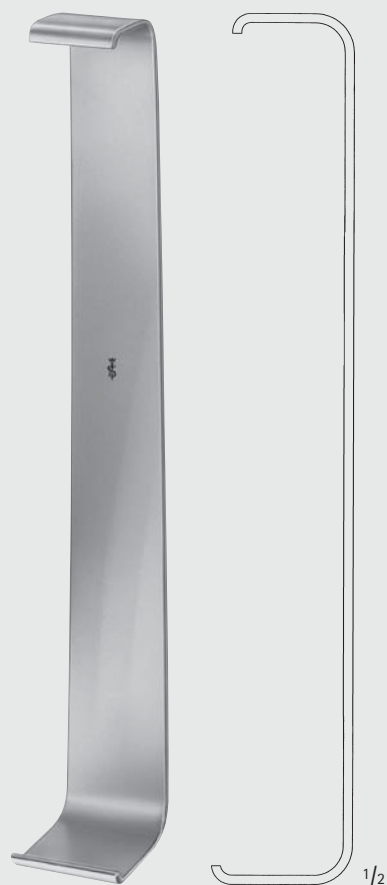

35 x 32 mm

LANE

BT038R

230 mm, 9"

38 x 22 mm

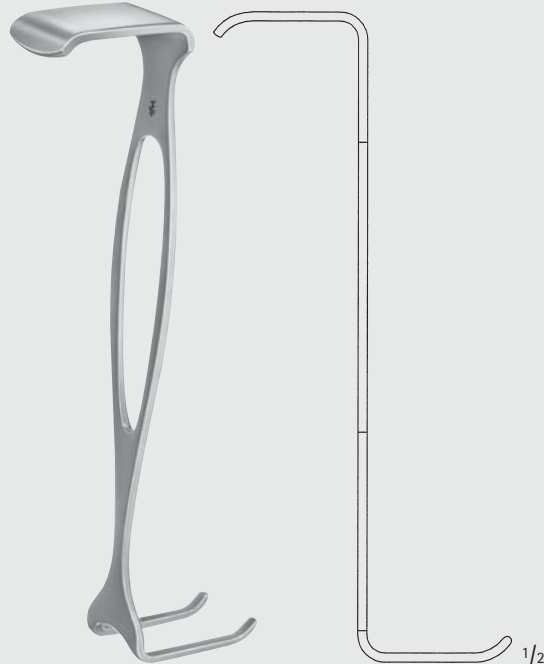

38 x 22 mm

CZERNY

BT042R

175 mm, 7"

BT





Wundhaken – Wound Retractors

Wundhaken
Retractors

BT

30 x 18 mm

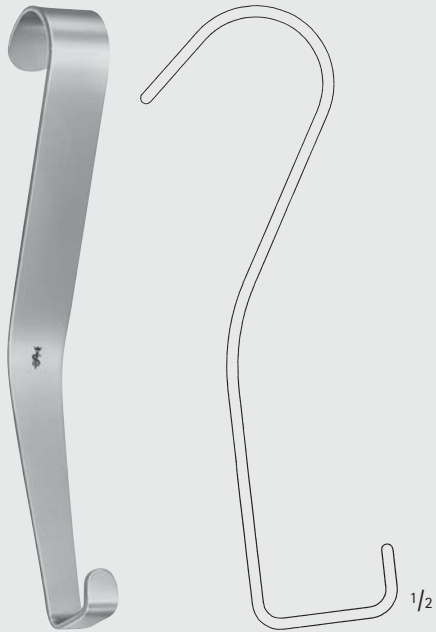

25 x 10 mm

HAJEK

OL221R

165 mm, 6 1/2"

47 x 13 mm
41 x 13 mm



37 x 25 mm
45 x 25 mm

MATHIEU

BT040R

200 mm, 8"

38 x 22 mm

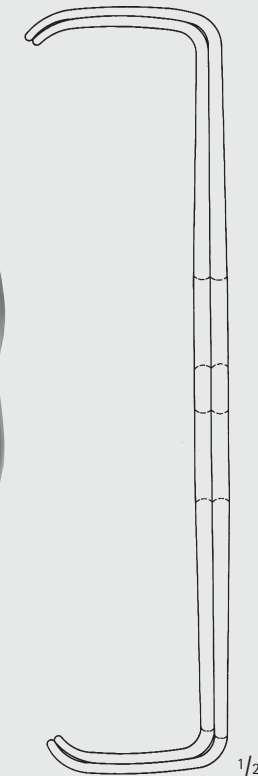

38 x 22 mm

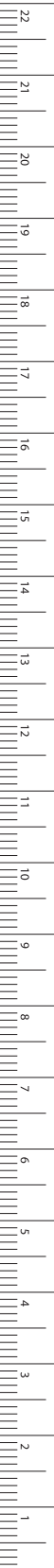

MILLIMETERS

Wundhaken – Wound Retractors

Wundhaken

Retractors

Maßangaben für Blattgrößen der Wundhaken

1. Zahl = Tiefe Beispiel: 25 x 38 mm

2. Zahl = Breite

Dimensions for blade size of retractors

1st number = depth Example: 25 x 38 mm

2nd number = width

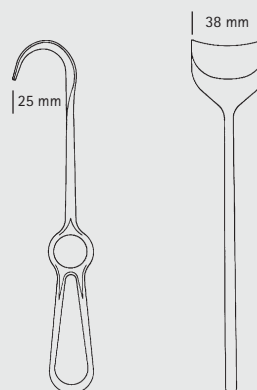

26 x 15 mm
22 x 15 mm

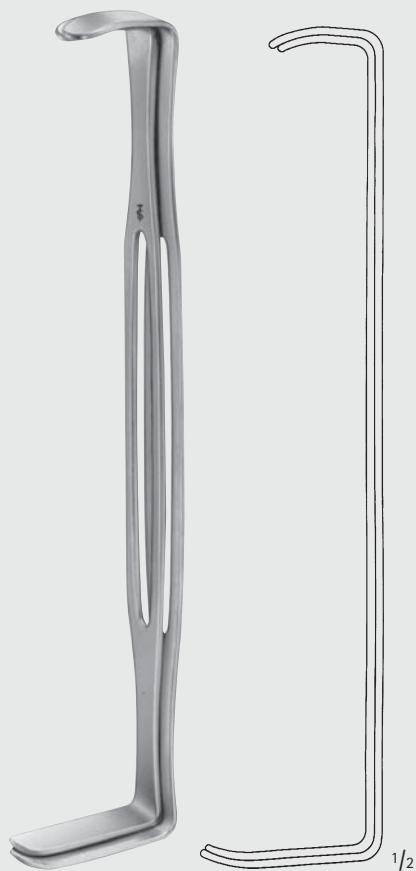

39 x 15 mm
43 x 15 mm

US-ARMY

BT041R

220 mm, 8 3/4"



GOELET

MD497

190 mm, 7 1/2"



CANNY-RYALL

Blattbreite
Blade width

BT047R 190 mm, 7 1/2" 16 mm

BT048R 190 mm, 7 1/2" 20 mm

BT049R 200 mm, 8" 25 mm

BT





Wundhaken – Wound Retractors
Knochen- und Wundhaken
Bone Retractors and Retractors

BT



KOCHER
BT234R
scharf
sharp
205 mm, 8"

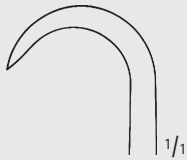

KOCHER
BT238R
scharf
sharp
220 mm, 8 3/4"

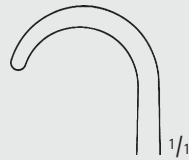

KOCHER
BT239R
stumpf
blunt
220 mm, 8 3/4"

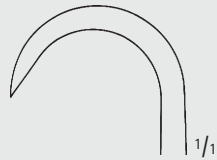

VOLKMANN
BT240R
scharf
sharp
220 mm, 8 3/4"

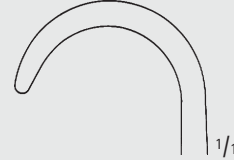

VOLKMANN
BT241R
stumpf
blunt
220 mm, 8 3/4"



BT232R
scharf
sharp
245 mm, 9 3/4"

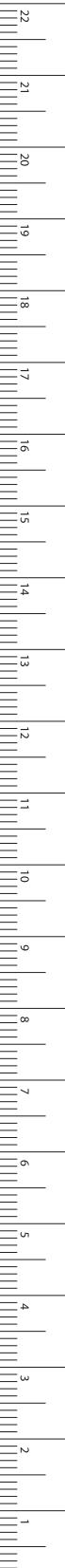

MILLIMETERS

Wundhaken – Wound Retractors

Knochen- und Wundhaken

Bone Retractors and Retractors

Maßangaben für Blattgrößen der Wundhaken

1. Zahl = Tiefe Beispiel: 25 x 38 mm

2. Zahl = Breite

Dimensions for blade size of retractors

1st number = depth Example: 25 x 38 mm

2nd number = width

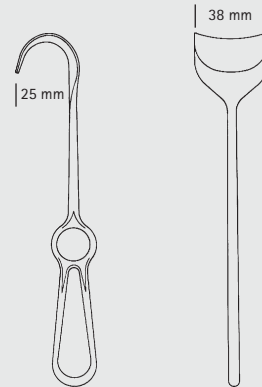

VOLKMANN

BT221R

scharf

sharp

220 mm, 8 3/4"

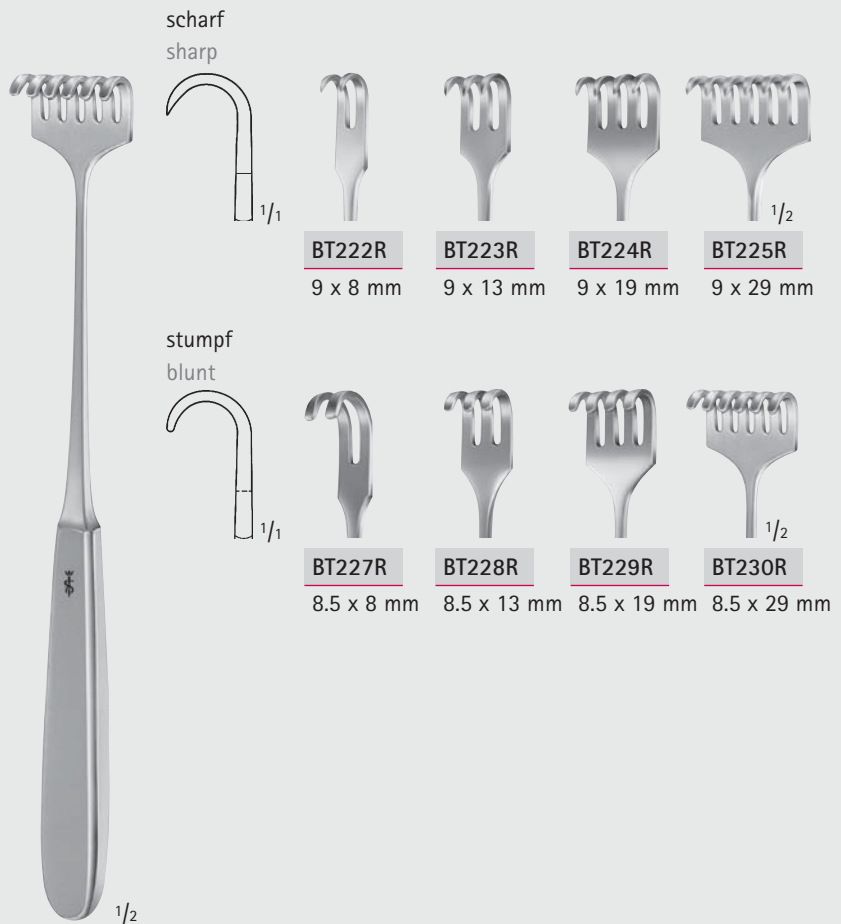

VOLKMANN

BT222R–BT230R

225 mm, 9"

BT222R

9 x 8 mm

BT223R

9 x 13 mm

BT224R

9 x 19 mm

BT225R

9 x 29 mm

BT227R

8.5 x 8 mm

BT228R

8.5 x 13 mm

BT229R

8.5 x 19 mm

BT230R

8.5 x 29 mm

BT





Wundhaken – Wound Retractors

Wundhaken Retractors

BT

scharf
sharp

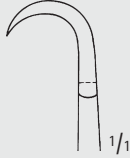

BT242R
9 x 8 mm



BT243R
9 x 13 mm



BT244R
9 x 19 mm



BT246R
9 x 29 mm



BT248R
9 x 40 mm

stumpf
blunt



BT252R
8 x 8 mm



BT253R
8 x 13 mm



BT254R
8 x 19 mm



BT256R
8 x 29 mm



BT258R
8 x 40 mm

halbscharf
semi-sharp



BT257R
8.5 x 8 mm



BT259R
8.5 x 13 mm



BT260R
8.5 x 19 mm



BT261R
8.5 x 29 mm



BT265R
8,5 x 40 mm



1/2

VOLKMANN

BT242R-BT265R

220 mm, 8 3/4"

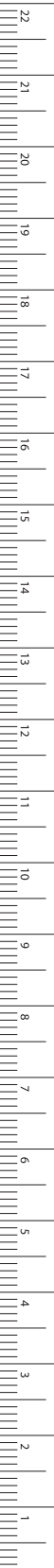

MILLIMETERS

Wundhaken – Wound Retractors

Wundhaken

Retractors

Maßangaben für Blattgrößen der Wundhaken

1. Zahl = Tiefe Beispiel: 25 x 38 mm

2. Zahl = Breite

Dimensions for blade size of retractors

1st number = depth Example: 25 x 38 mm

2nd number = width

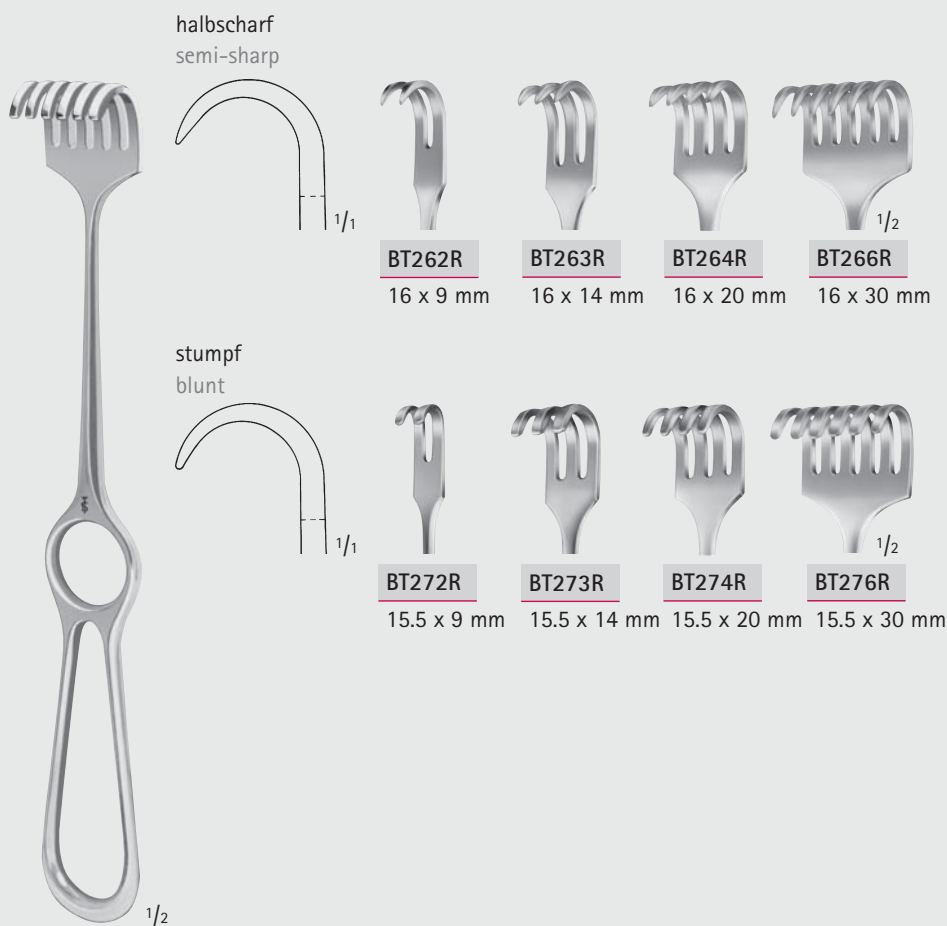
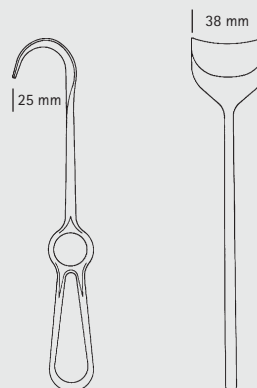

KOCHER

BT262R-BT276R

220 mm, 8 3/4"

BT





Wundhaken – Wound Retractors

Wundhaken
Retractors

BT

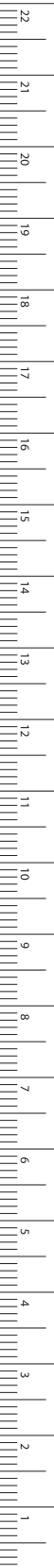

MILLIMETERS

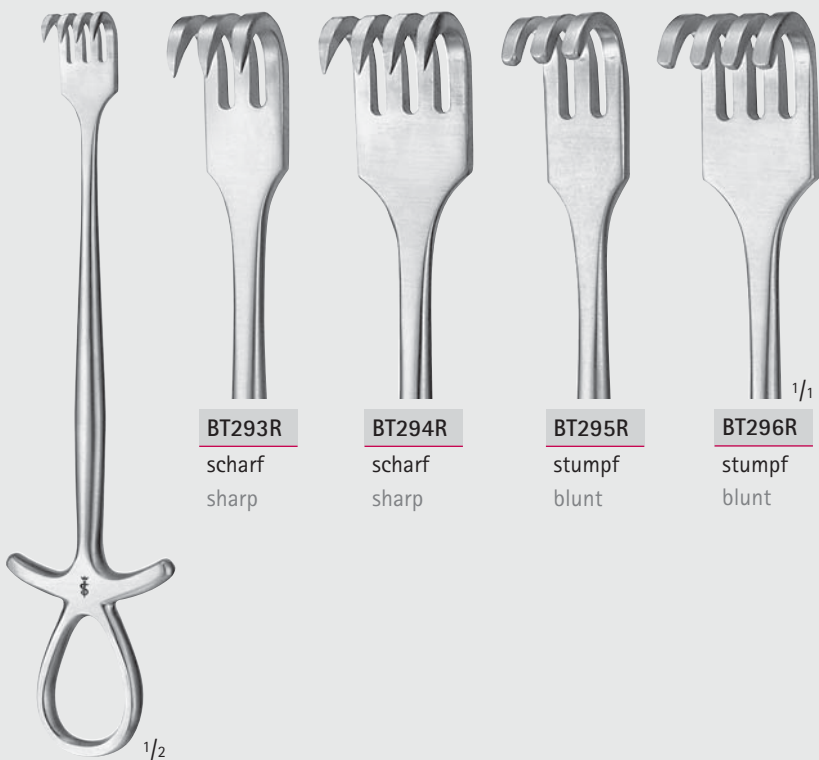

BT293R

scharf
sharp

BT294R

scharf
sharp

BT295R

stumpf
blunt

BT296R

stumpf
blunt

MURPHY

BT293R-BT296R

195 mm, 7 ³/₄"

¹/₂

¹/₁

Wundhaken – Wound Retractors

Wundhaken, tiefe Form

Retractors, Deep Form

Maßangaben für Blattgrößen der Wundhaken

1. Zahl = Tiefe Beispiel: 25 x 38 mm

2. Zahl = Breite

Dimensions for blade size of retractors

1st number = depth Example: 25 x 38 mm

2nd number = width



BT278R

8 Zähne, stumpf
8 prongs, blunt

BT279R

8 Zähne, halbscharf
8 prongs, semi-sharp

KÖRTE

BT278R-BT279R

Griff vertikal zum Blatt
Handle vertical to the blade
240 mm, 9 1/2"



KÖRTE

BT280R

4 Zähne, stumpf
Griff vertikal zum Blatt
4 prongs, blunt
handle vertical to the blade
230 mm, 9"



KÖRTE-WAGNER

BT290R

8 Zähne, halbscharf
8 prongs, semi-sharp
280 mm, 11"

BT



INCHES



Wundhaken – Wound Retractors

Wundhaken, tiefe Form
Retractors, Deep Form

BT

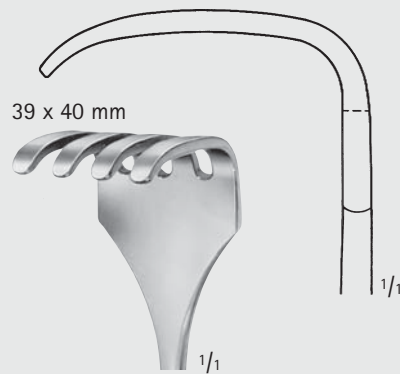
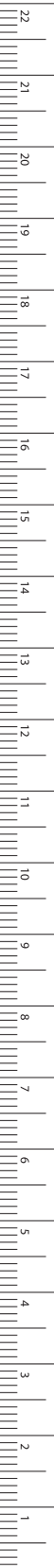

BT284R
4 Zähne, stumpf
4 prongs, blunt

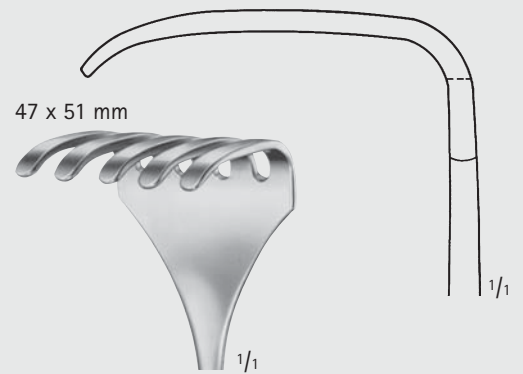

BT285R
5 Zähne, stumpf
5 prongs, blunt

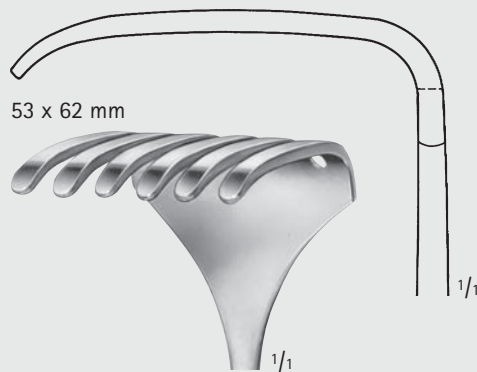

BT286R
6 Zähne, stumpf
6 prongs, blunt

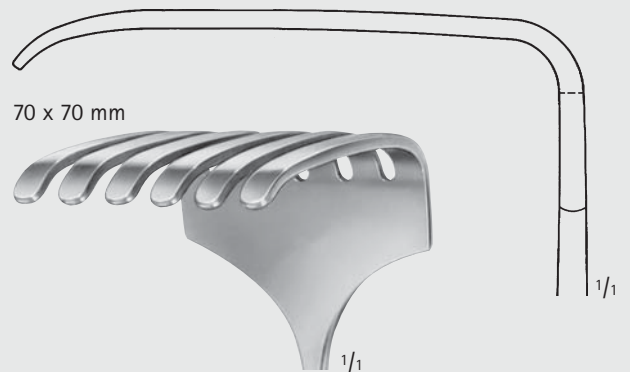

BT287R
6 Zähne, stumpf
6 prongs, blunt

ISRAEL

BT284R-BT287R

255 mm, 10"

MILLIMETERS

Wundhaken – Wound Retractors

Wundhaken

Retractors

Maßangaben für Blattgrößen der Wundhaken

1. Zahl = Tiefe Beispiel: 25 x 38 mm

2. Zahl = Breite

Dimensions for blade size of retractors

1st number = depth Example: 25 x 38 mm

2nd number = width

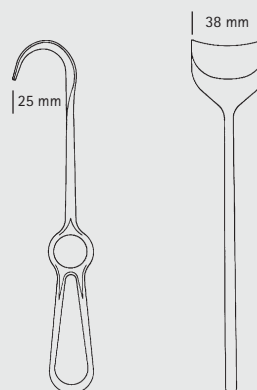

OLLIER

BT288R

4 Zähne, stumpf

4 prongs, blunt

230 mm, 9"



LANGENBECK

BT311R-BT316R

230 mm, 9"

BT311R

30 x 10 mm

BT315R

40 x 10 mm

BT316R

43 x 13 mm



Wundhaken – Wound Retractors

Wundhaken
Retractors

BT

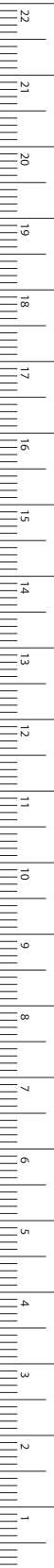

MILLIMETERS

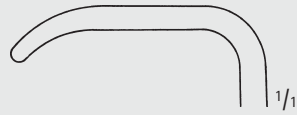

BT320R
28 x 10 mm

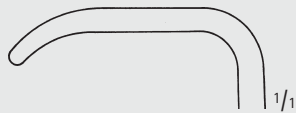

BT321R
28 x 14 mm

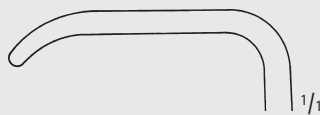

BT322R
33 x 14 mm

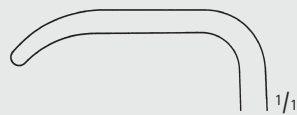

BT323R
28 x 16 mm

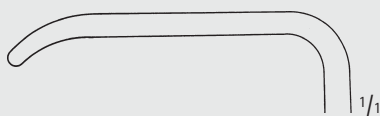

BT325R
40 x 10 mm

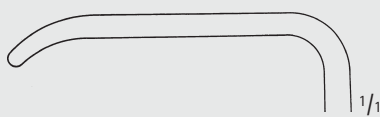

BT326R
40 x 13 mm



LANGENBECK

BT320R-BT326R
210 mm, 8 1/4"

1/2

1/1

1/1

1/1

1/1

1/1

1/1

Wundhaken – Wound Retractors

Wundhaken

Retractors

Maßangaben für Blattgrößen der Wundhaken

1. Zahl = Tiefe Beispiel: 25 x 38 mm

2. Zahl = Breite

Dimensions for blade size of retractors

1st number = depth Example: 25 x 38 mm

2nd number = width

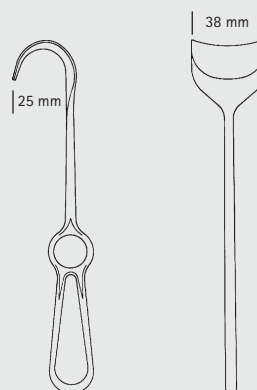

BT



1/2

KOCHER-LANGENBECK

BT354R-BT365R

215 mm, 8 1/2"

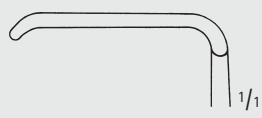

BT354R

25 x 6 mm

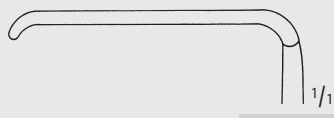

BT356R

35 x 8 mm

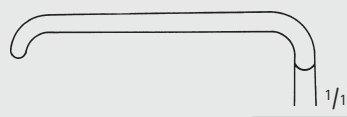

BT357R

35 x 11 mm

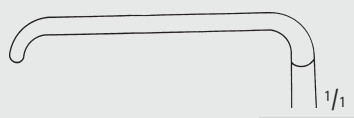

BT358R

35 x 15 mm

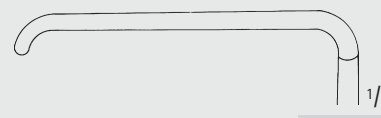

BT359R

41 x 11 mm

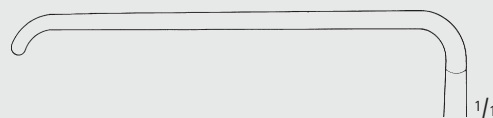

BT361R

55 x 11 mm

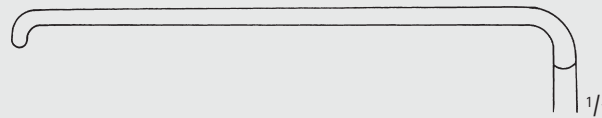

BT363R

70 x 14 mm

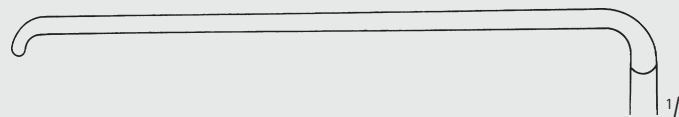

BT364R

80 x 12 mm

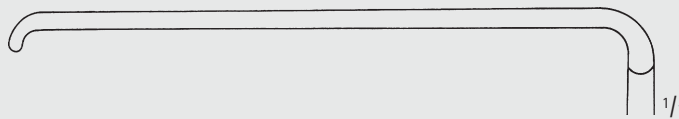

BT365R

80 x 16 mm



Wundhaken – Wound Retractors

Wundhaken
Retractors

BT

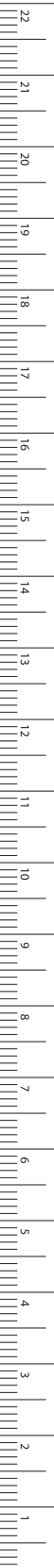

MILLIMETERS



23 x 8 mm
1/1

1/2

BT340R

210 mm, 8 1/4"

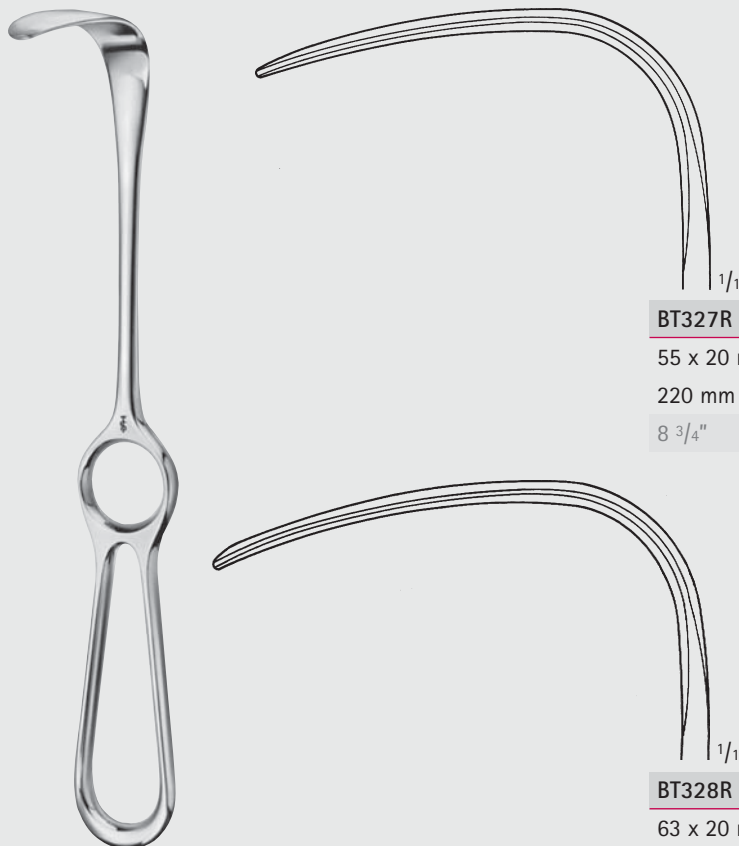

BT327R

55 x 20 mm

220 mm

8 3/4"

BT328R

63 x 20 mm

210 mm

8 1/4"

BT327R-BT328R

Wundhaken – Wound Retractors

Wundhaken

Retractors

Maßangaben für Blattgrößen der Wundhaken

1. Zahl = Tiefe Beispiel: 25 x 38 mm

2. Zahl = Breite

Dimensions for blade size of retractors

1st number = depth Example: 25 x 38 mm

2nd number = width

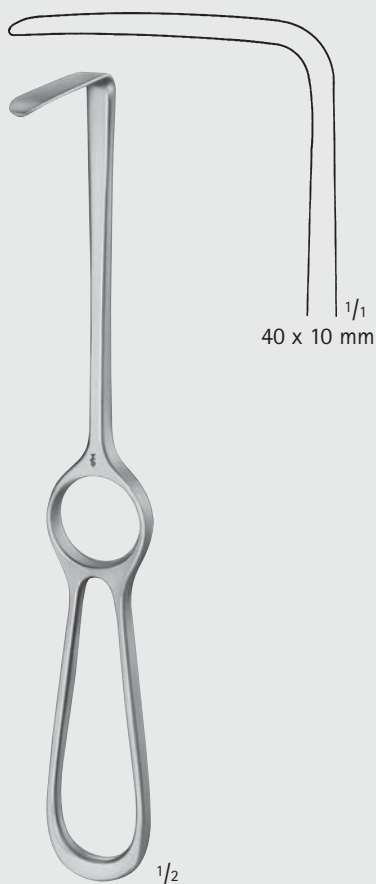
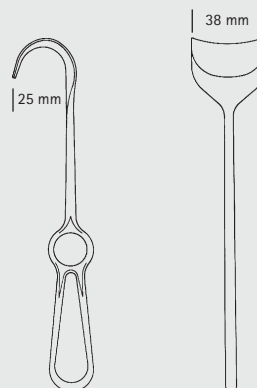

BT343R

215 mm, 8 1/2"

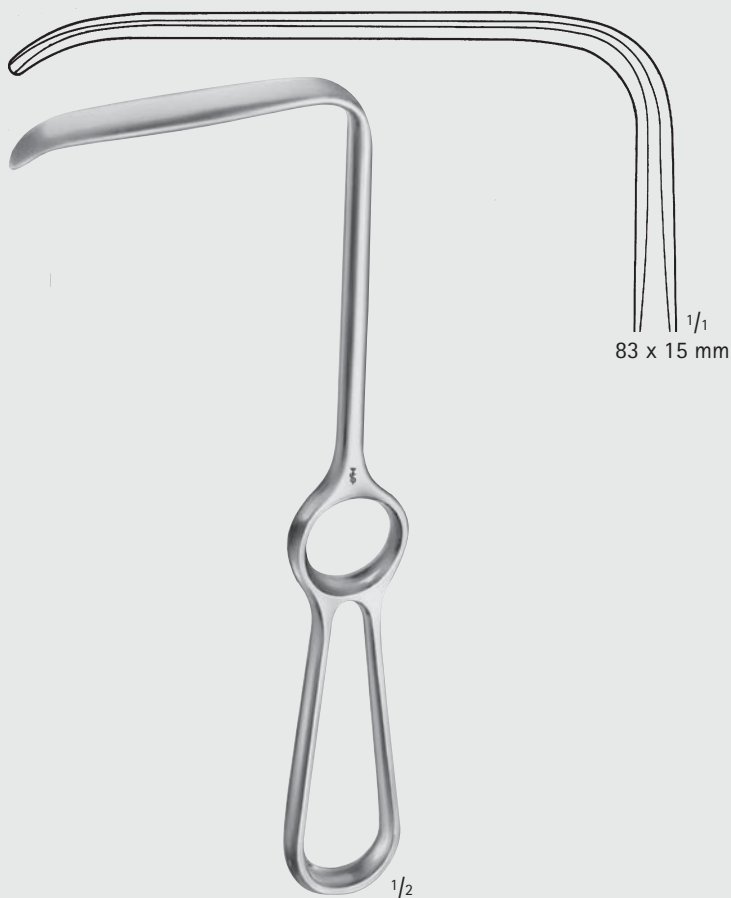

LANGENBECK

BT332R

Griff vertikal zum Blatt

Handle vertical to the blade

215 mm, 8 1/2"

BT



INCHES



Wundhaken – Wound Retractors

Wund- und Meniskushaken
Retractors and Knee Retractors

BT

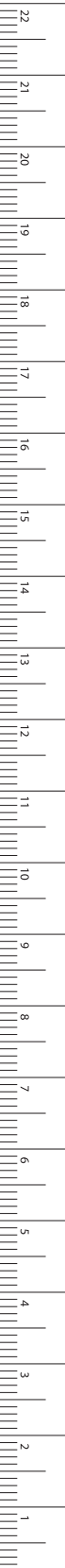
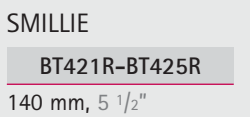
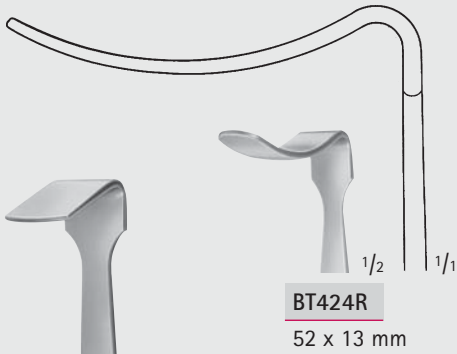
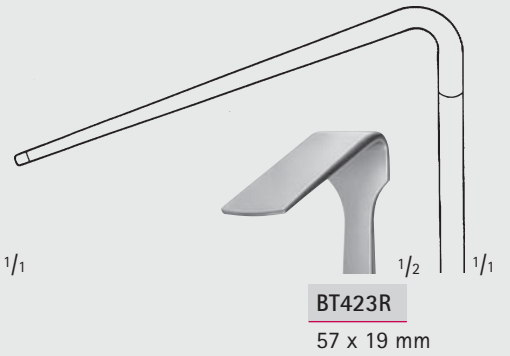
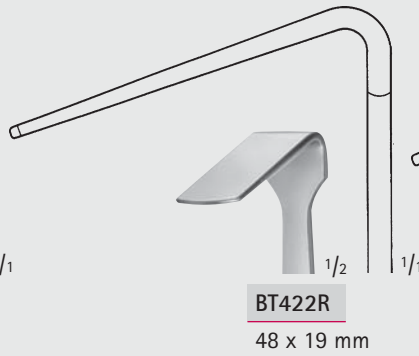
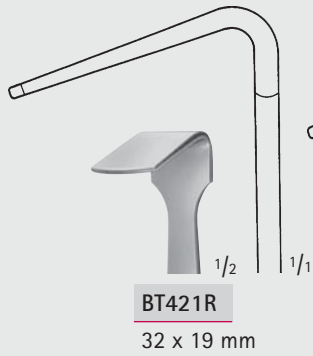

MILLIMETERS

Wundhaken – Wound Retractors

Wund- und Meniskushaken

Retractors and Knee Retractors

Maßangaben für Blattgrößen der Wundhaken

1. Zahl = Tiefe Beispiel: 25 x 38 mm

2. Zahl = Breite

Dimensions for blade size of retractors

1st number = depth Example: 25 x 38 mm

2nd number = width

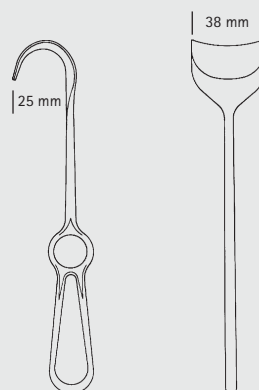

BT419R

225 mm, 9"

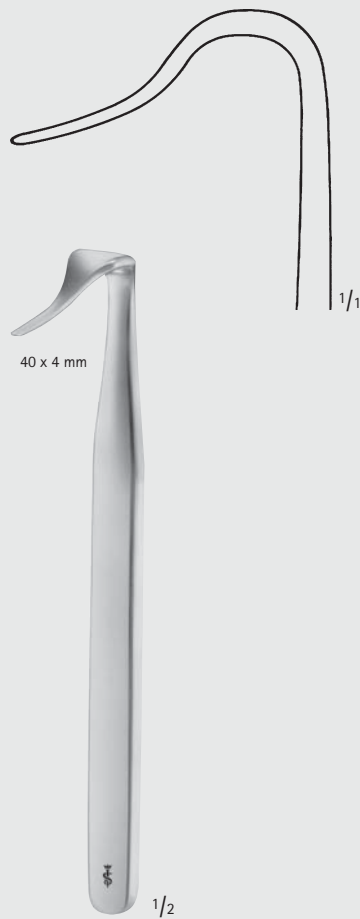

BLOUNT

BT420R

175 mm, 7"

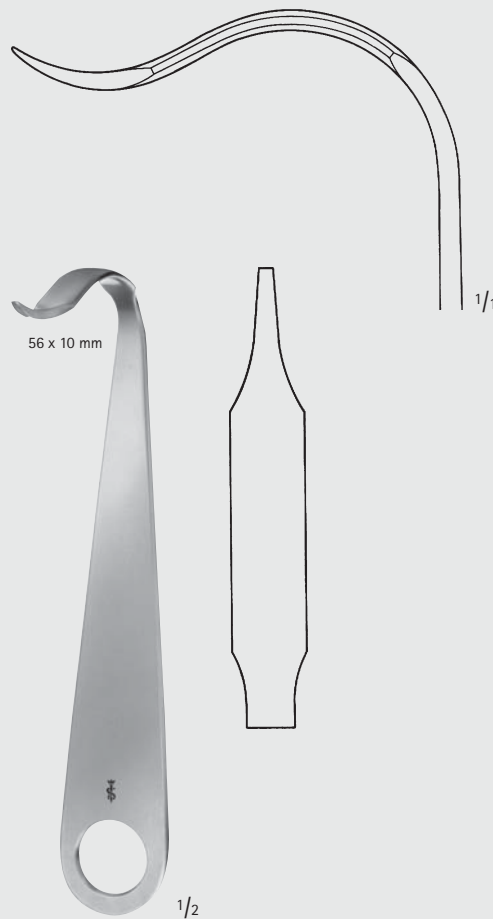

BT430R

170 mm, 6 3/4"

BT





Wundhaken – Wound Retractors

Wundhaken
Retractors

BT

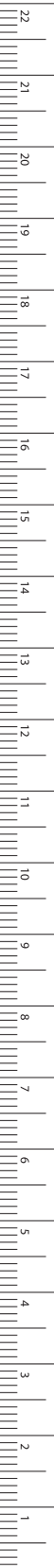

D0450R
25 x 7 mm

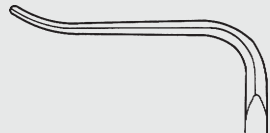

D0451R
31 x 10 mm

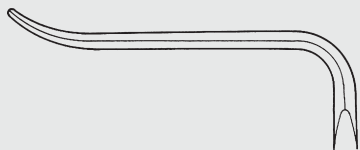

D0452R
42 x 11 mm

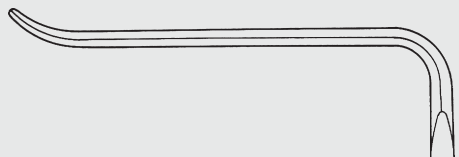

D0453R
55 x 12 mm

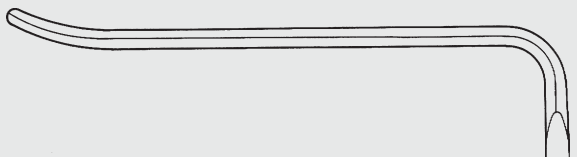

D0454R
70 x 14 mm

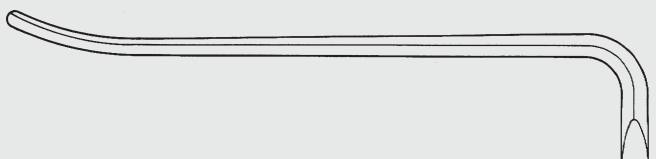

D0455R
80 x 16 mm



OBWEGESER

D0450R-D0455R

215 mm, 8 1/2"

MILLIMETERS

Wundhaken – Wound Retractors

Wundhaken

Retractors

Maßangaben für Blattgrößen der Wundhaken

1. Zahl = Tiefe Beispiel: 25 x 38 mm

2. Zahl = Breite

Dimensions for blade size of retractors

1st number = depth Example: 25 x 38 mm

2nd number = width



OBWEGESER

DO460R-DO465R

215 mm, 8 1/2"



DO460R

25 x 7 mm

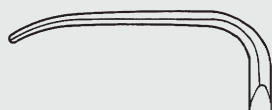

DO461R

31 x 10 mm

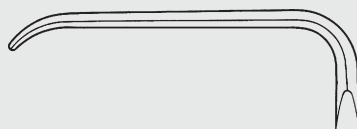

DO462R

42 x 11 mm

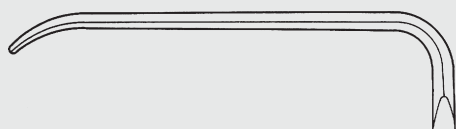

DO463R

55 x 12 mm

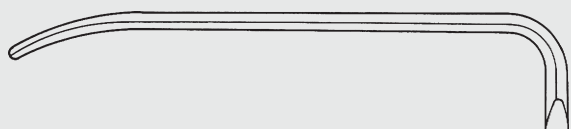

DO464R

70 x 14 mm

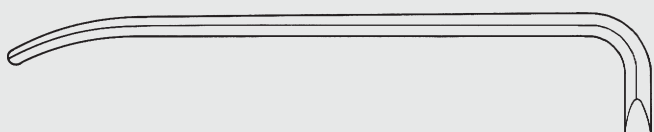

DO465R

80 x 16 mm

BT





Wundhaken – Wound Retractors

Wundhaken
Retractors

BT

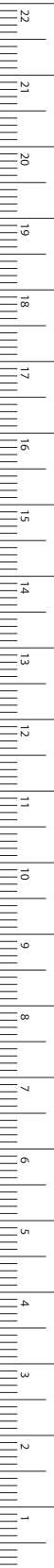

KOCHER

BT369R-BT373R

230 mm, 9"

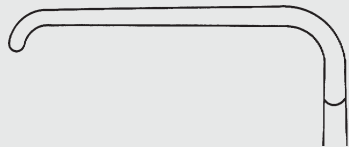

BT369R

40 x 18 mm

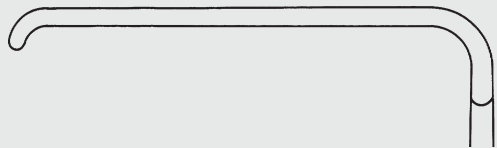

BT370R

60 x 20 mm

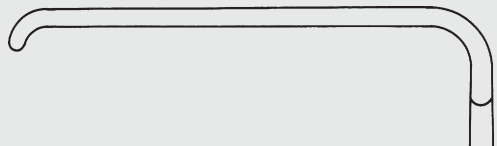

BT371R

60 x 25 mm

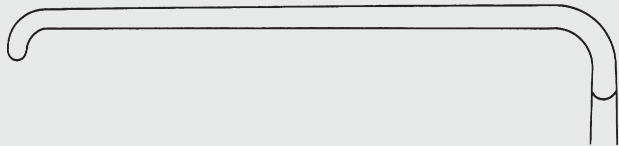

BT372R

75 x 30 mm

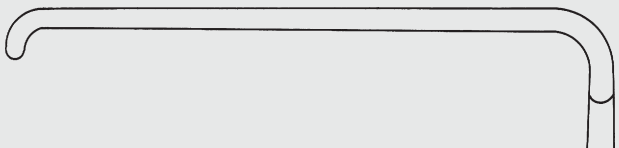

BT373R

75 x 40 mm

MILLIMETERS

Wundhaken – Wound Retractors

Wundhaken

Retractors

Maßangaben für Blattgrößen der Wundhaken

1. Zahl = Tiefe Beispiel: 25 x 38 mm

2. Zahl = Breite

Dimensions for blade size of retractors

1st number = depth Example: 25 x 38 mm

2nd number = width

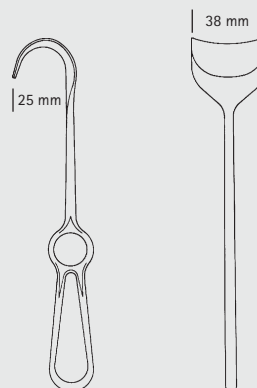

SAUERBRUCH

BT351R-BT353R

225 mm, 9"

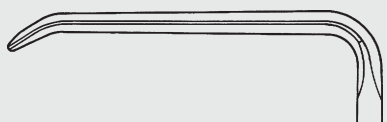

BT351R

46 x 16 mm

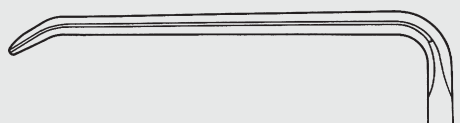

BT352R

55 x 22 mm

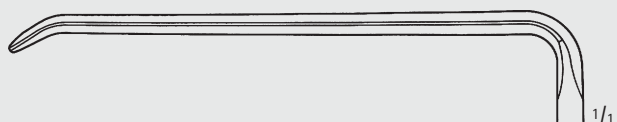

BT353R

72 x 19 mm



LAHEY

MB785R

200 mm, 8"

BT





Wundhaken – Wound Retractors

Wundhaken
Retractors

BT

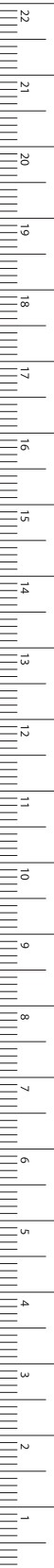
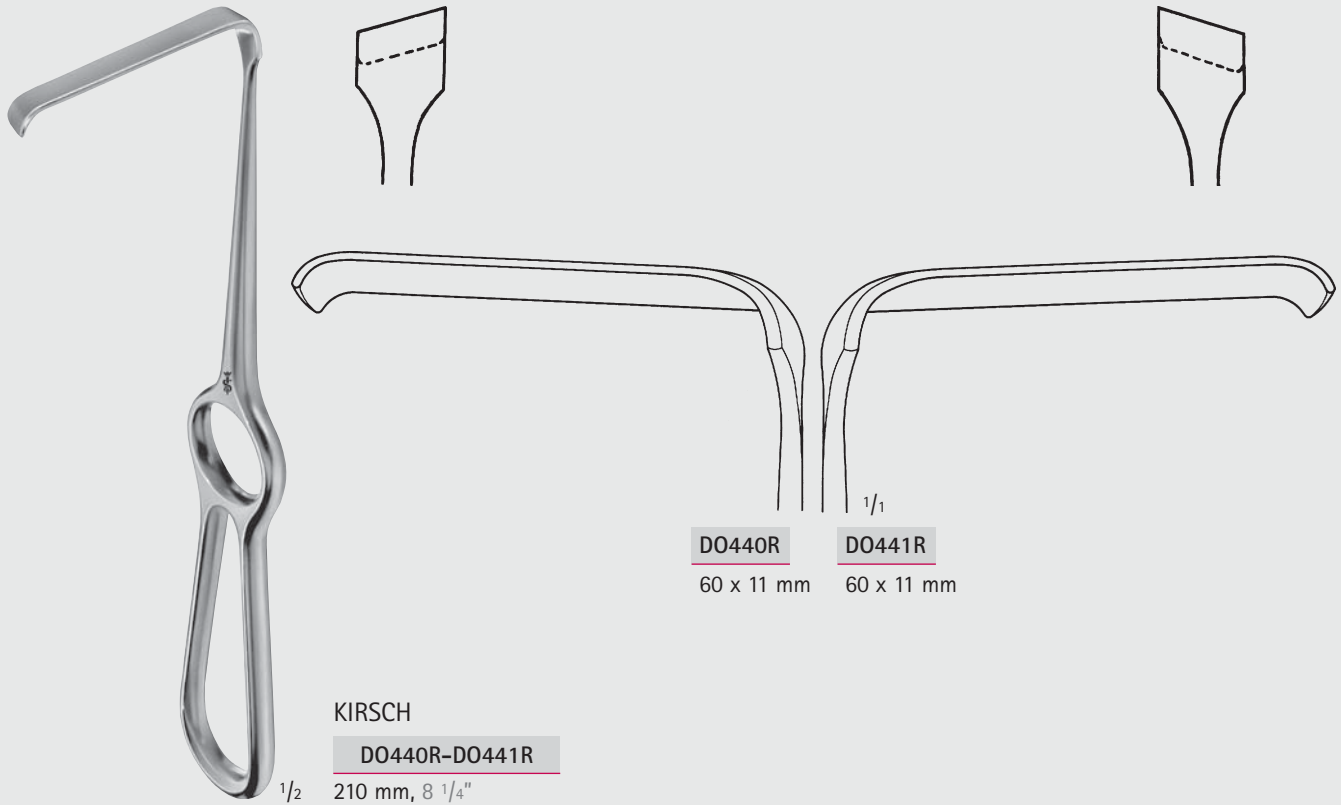

MILLIMETERS



DURHAM
BT400R
215 mm, 8 1/2"

Wundhaken – Wound Retractors

Wundhaken

Retractors

Maßangaben für Blattgrößen der Wundhaken

1. Zahl = Tiefe Beispiel: 25 x 38 mm

2. Zahl = Breite

Dimensions for blade size of retractors

1st number = depth Example: 25 x 38 mm

2nd number = width

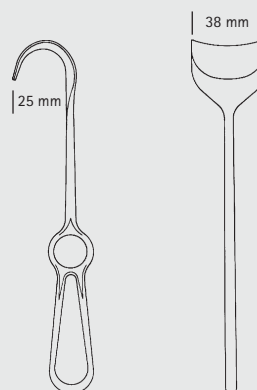

BT



BT404R

15 x 15 mm

220 mm

8 3/4"

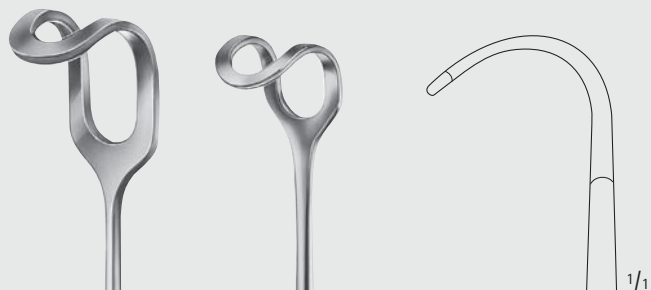

BT405R

20 x 22 mm

215 mm

8 1/2"

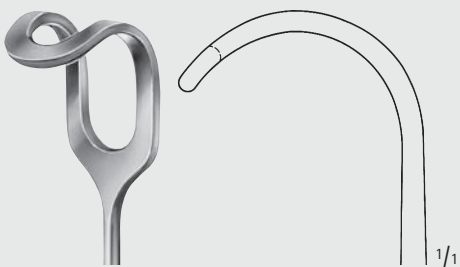

BT406R

28 x 28 mm

235 mm

9 1/4"

MIDDELDORPF

BT404R-BT406R



22 x 22 mm

GREENE

BT408R

225 mm, 9"



Wundhaken – Wound Retractors
Wundhaken
Retractors

BT



BÜCHS

DO432R

205 mm, 8"

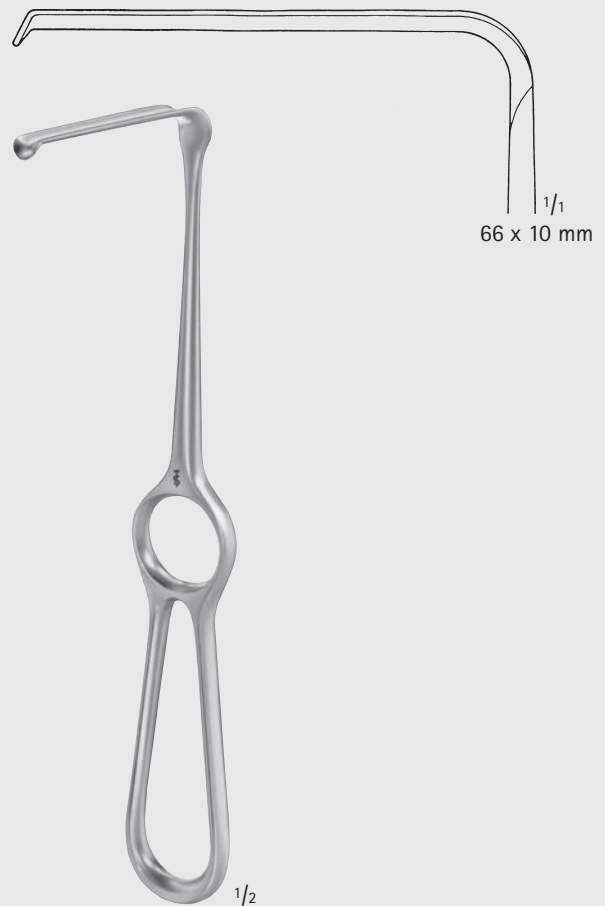

KRÄMER

BT464R

210 mm, 8 1/4"



MILLIMETERS

Wundhaken – Wound Retractors

Wundhaken

Retractors

Maßangaben für Blattgrößen der Wundhaken

1. Zahl = Tiefe Beispiel: 25 x 38 mm

2. Zahl = Breite

Dimensions for blade size of retractors

1st number = depth Example: 25 x 38 mm

2nd number = width

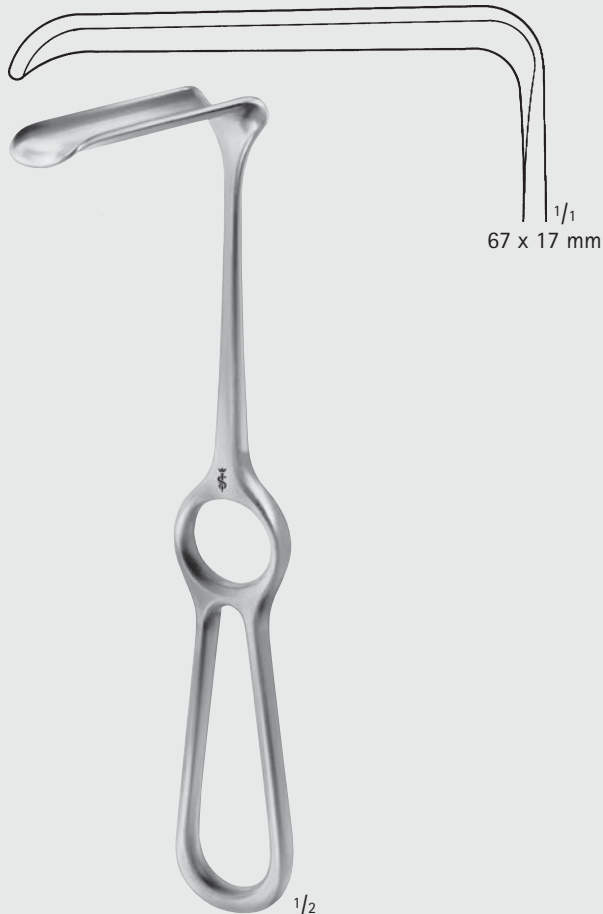
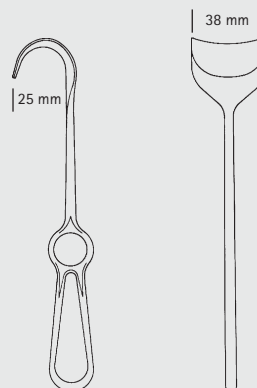

CASPAR

BT465R

210 mm, 8 1/4"

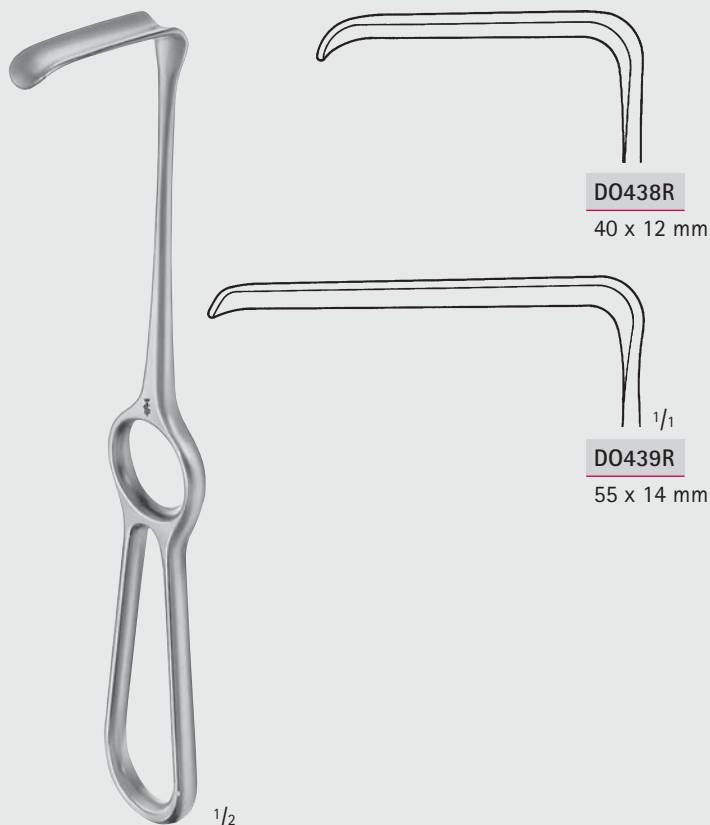

DOCKHORN

DO438R-DO439R

210 mm, 8 1/4"

BT





Wundhaken – Wound Retractors
Wundhaken
Retractors

BT

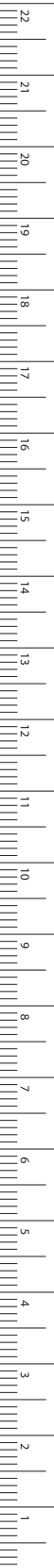

MILLIMETERS



KOCHER

BT459R

230 mm, 9"



BT460R

67 x 25 mm

BT461R

80 x 42 mm

BT462R

80 x 50 mm

BT463R

80 x 60 mm

KOCHER

BT460R-BT463R

250 mm, 10"

Wundhaken – Wound Retractors

Wundhaken

Retractors

Maßangaben für Blattgrößen der Wundhaken

1. Zahl = Tiefe Beispiel: 25 x 38 mm

2. Zahl = Breite

Dimensions for blade size of retractors

1st number = depth Example: 25 x 38 mm

2nd number = width

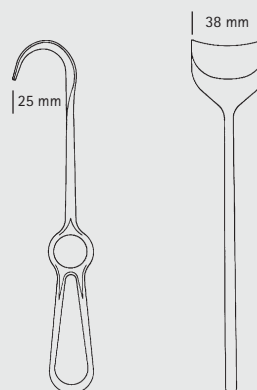

BT





Wundhaken – Wound Retractors

Wundhaken
Retractors

BT

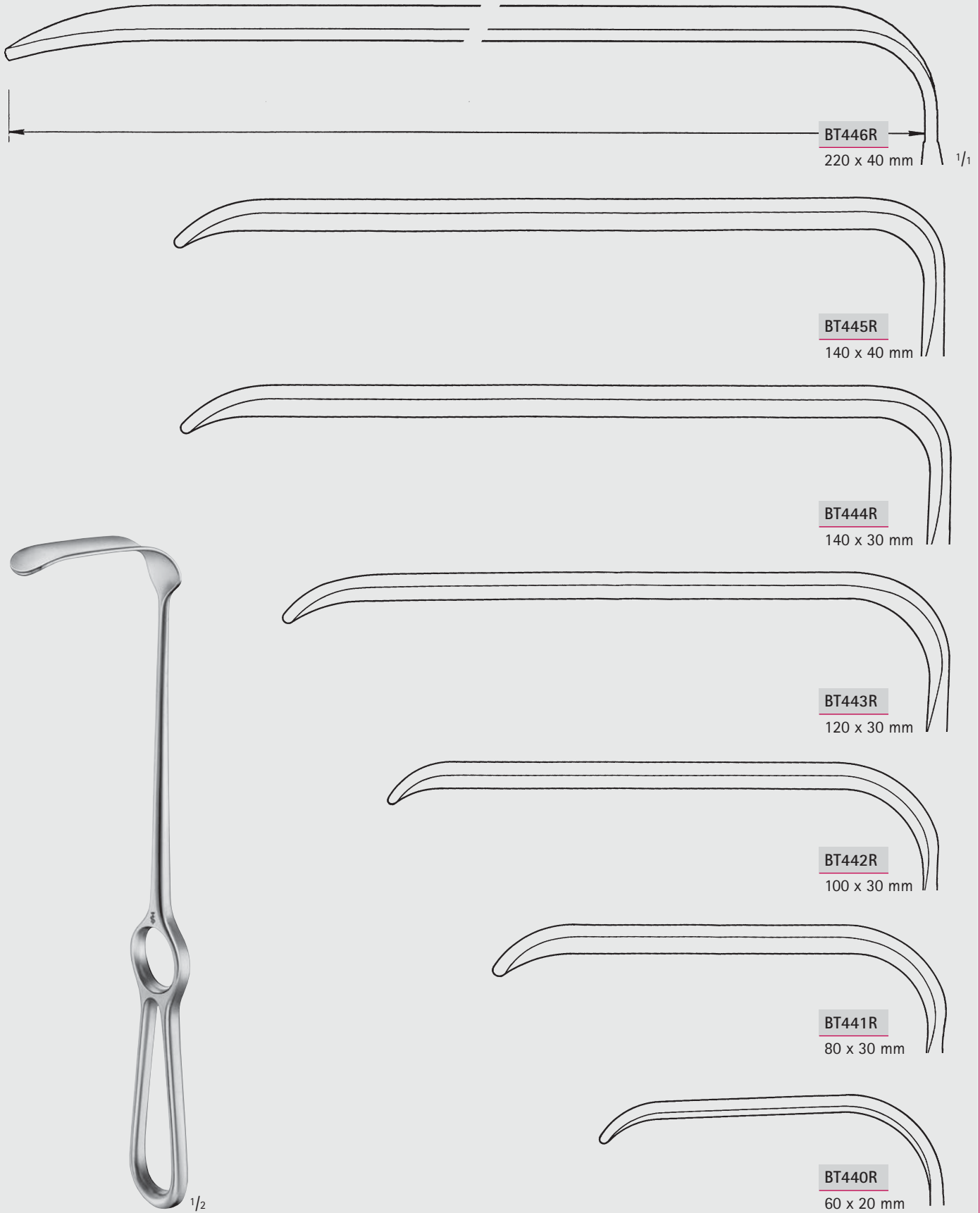

BT446R

220 x 40 mm

1/1

BT445R

140 x 40 mm

BT444R

140 x 30 mm

BT443R

120 x 30 mm

BT442R

100 x 30 mm

BT441R

80 x 30 mm

BT440R

60 x 20 mm

HÖSEL

BT440R-BT446R

250 mm, 10"

MILLIMETERS

Wundhaken – Wound Retractors

Wundhaken

Retractors

Maßangaben für Blattgrößen der Wundhaken

1. Zahl = Tiefe Beispiel: 25 x 38 mm

2. Zahl = Breite

Dimensions for blade size of retractors

1st number = depth Example: 25 x 38 mm

2nd number = width

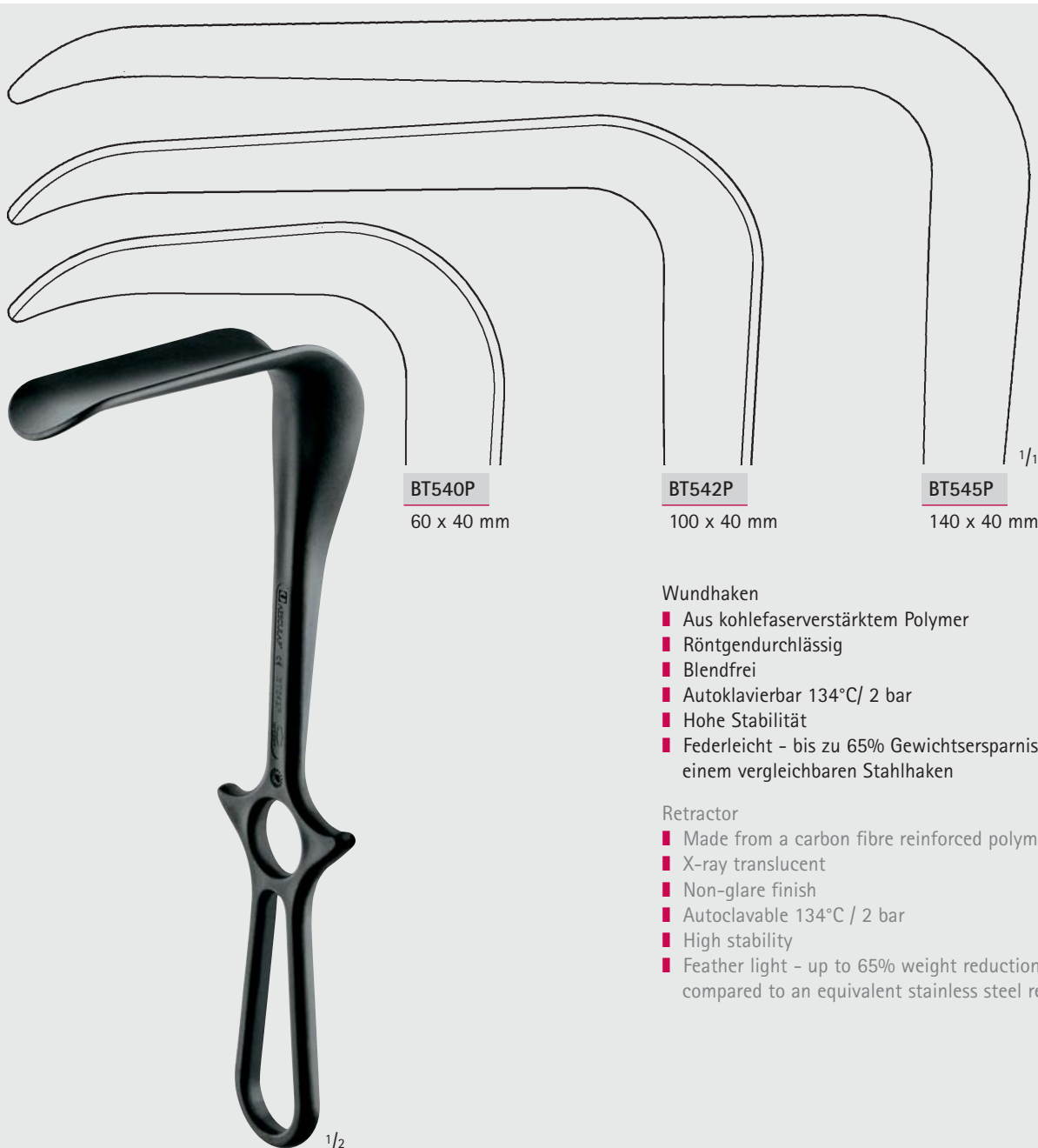
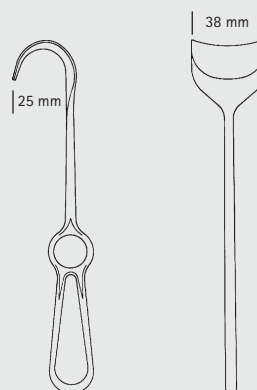

BT540P

60 x 40 mm

BT542P

100 x 40 mm

BT545P

140 x 40 mm

Wundhaken

- Aus kohlefaserverstärktem Polymer
- Röntgendurchlässig
- Blendfrei
- Autoklavierbar 134°C/ 2 bar
- Hohe Stabilität
- Federleicht - bis zu 65% Gewichtsersparnis zu einem vergleichbaren Stahlhaken

Retractor

- Made from a carbon fibre reinforced polymer
- X-ray translucent
- Non-glare finish
- Autoclavable 134°C / 2 bar
- High stability
- Feather light - up to 65% weight reduction compared to an equivalent stainless steel retractor

BT540P-BT545P

255 mm, 10"

INCHES

BT



Wundhaken – Wound Retractors
Wundhaken
Retractors

BT

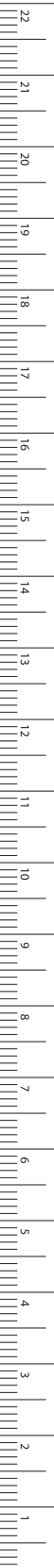

MILLIMETERS



RICHARDSON-EASTMAN

BT470R

Satz komplett,
bestehend aus:

Set complete,
consisting of:

BT471R
BT472R



RICHARDSON

BT475R–BT477R

240 mm, 9 1/2"

Wundhaken – Wound Retractors

Wundhaken

Retractors

Maßangaben für Blattgrößen der Wundhaken

1. Zahl = Tiefe Beispiel: 25 x 38 mm

2. Zahl = Breite

Dimensions for blade size of retractors

1st number = depth Example: 25 x 38 mm

2nd number = width

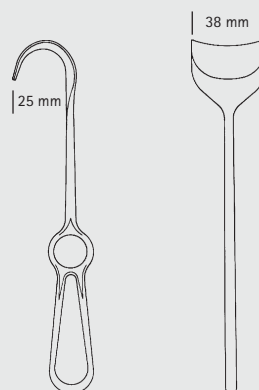

RICHARDSON

BT478R

240 mm, 9 1/2"



RICHARDSON

BT479R

250 mm, 10"

BT





Wundhaken – Wound Retractors
Wundhaken
Retractors

BT

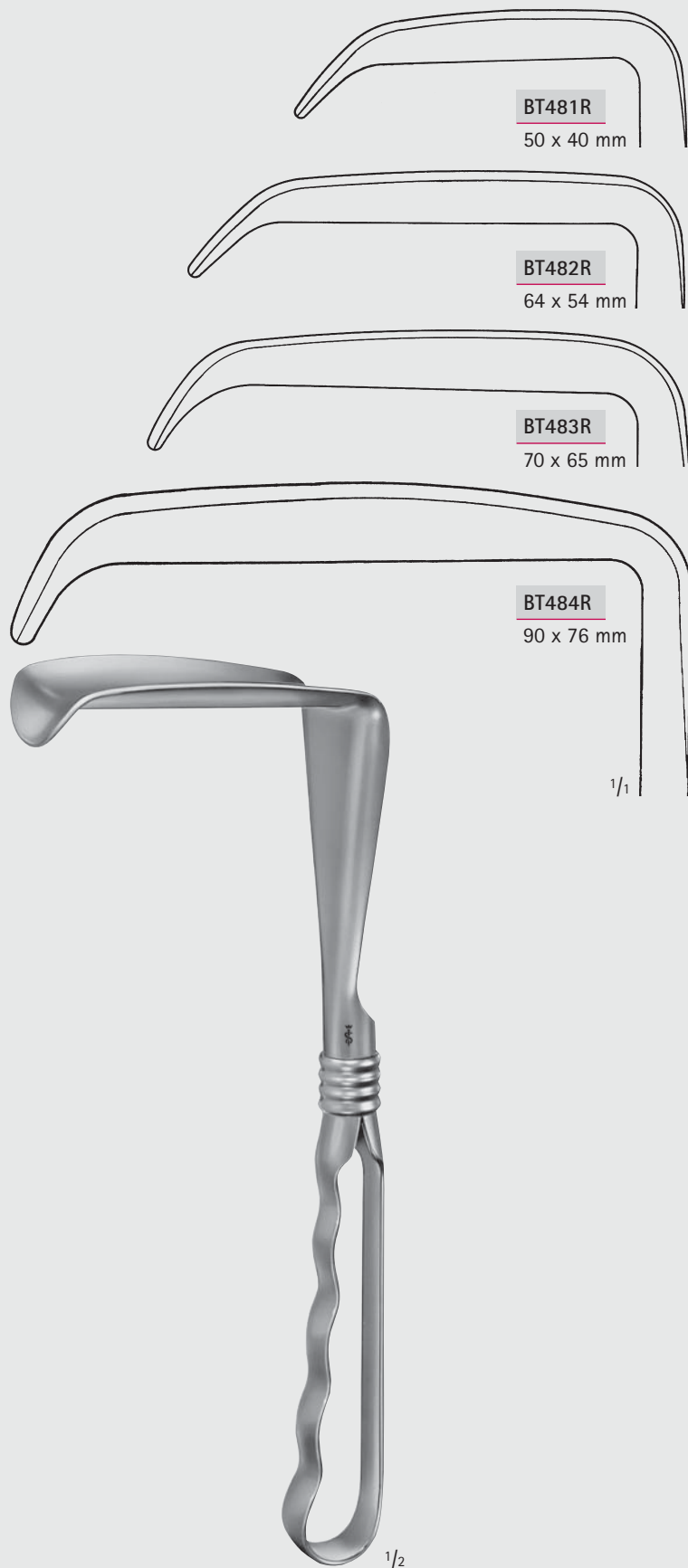

KELLY

BT481R–BT484R

260 mm, 10 1/4"

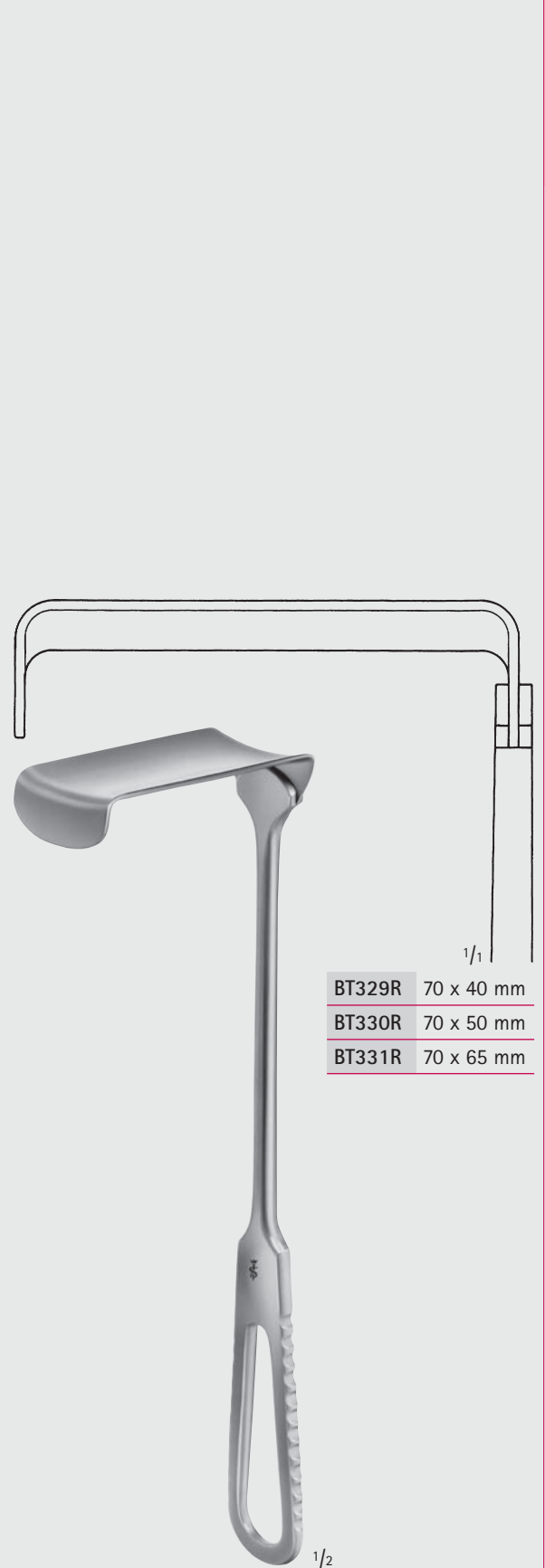

MORRIS

BT329R–BT331R

245 mm, 9 3/4"

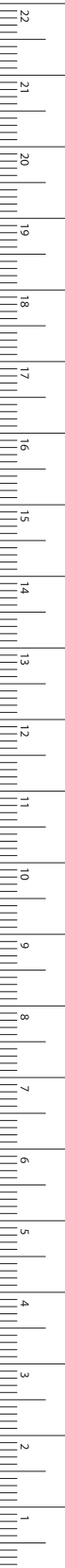

Wundhaken – Wound Retractors

Wundhaken
Retractors

Maßangaben für Blattgrößen der Wundhaken

1. Zahl = Tiefe Beispiel: 25 x 38 mm

2. Zahl = Breite

Dimensions for blade size of retractors

1st number = depth Example: 25 x 38 mm

2nd number = width

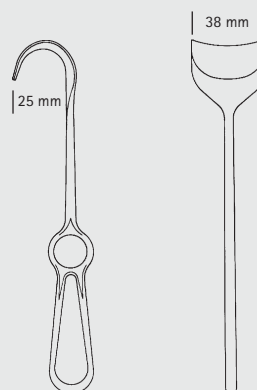

MEYERDING

BT485R-BT487R



BT485R

52 x 16 mm

230 mm

9"

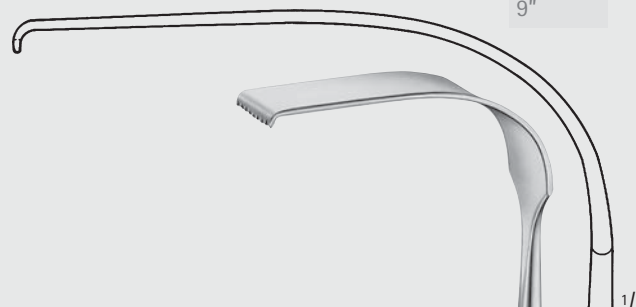

BT486R

76 x 25 mm

230 mm

9"

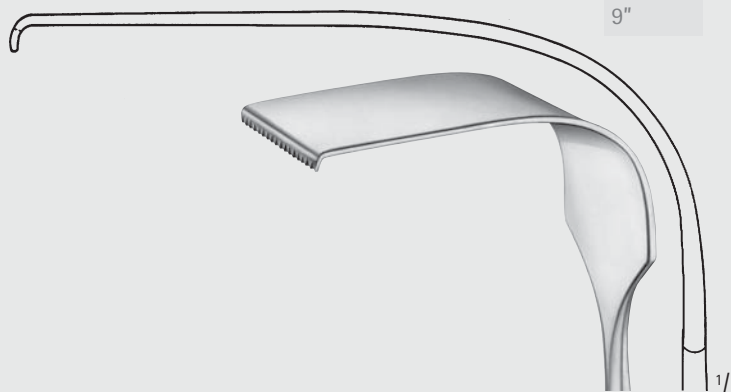

BT487R

89 x 50 mm

255 mm

10"

BT



Wundhaken – Wound Retractors

Wundhaken

Retractors

Maßangaben für Blattgrößen der Wundhaken

1. Zahl = Tiefe Beispiel: 25 x 38 mm

2. Zahl = Breite

Dimensions for blade size of retractors

1st number = depth Example: 25 x 38 mm

2nd number = width

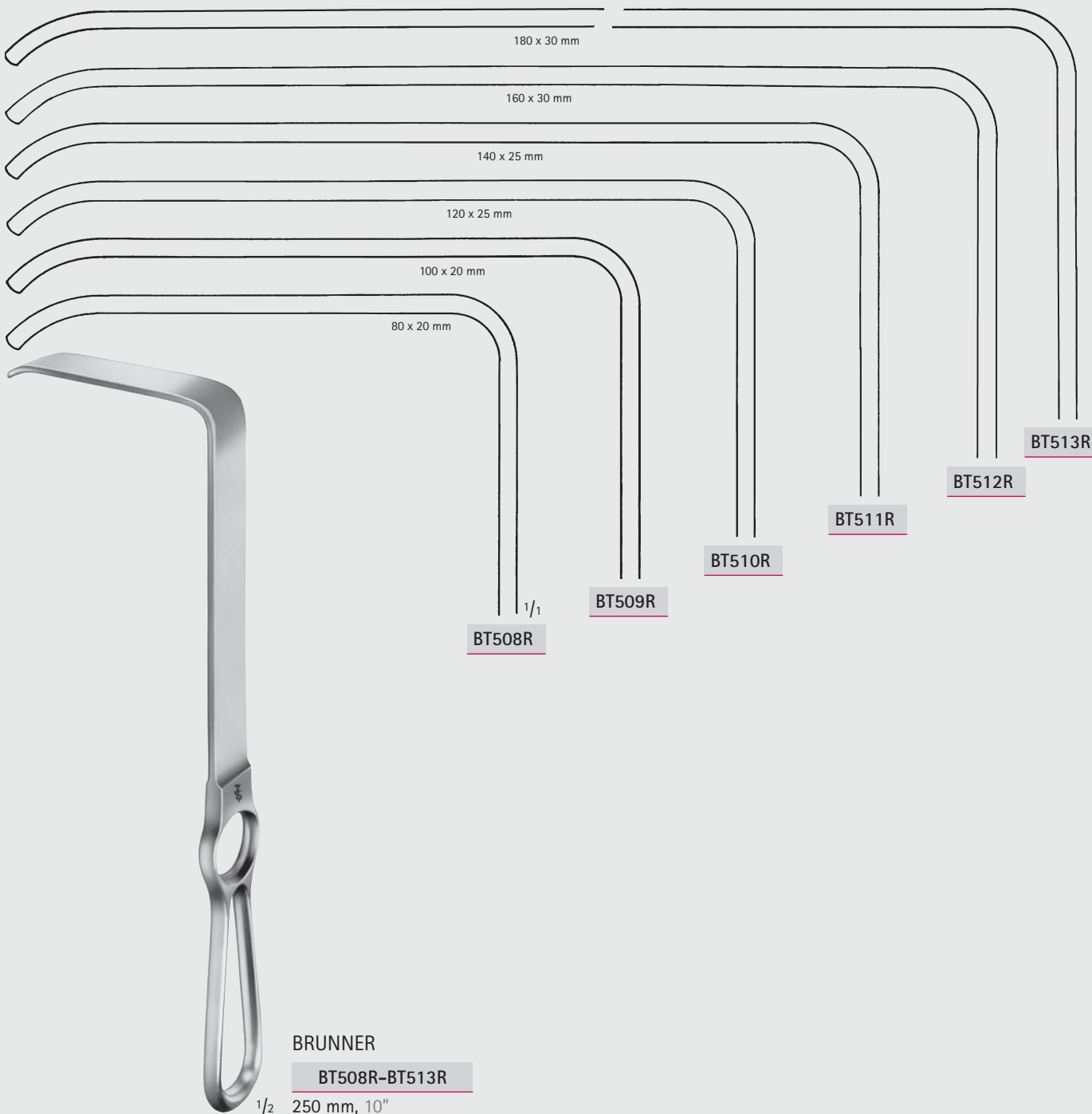
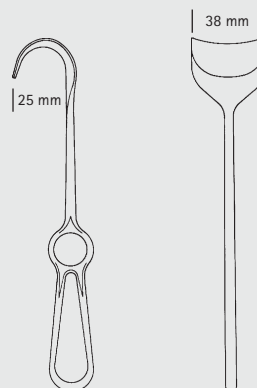

BT



BRUNNER

BT508R–BT513R

1/2 250 mm, 10"



Wundhaken – Wound Retractors

Wundhaken
Retractors

BT

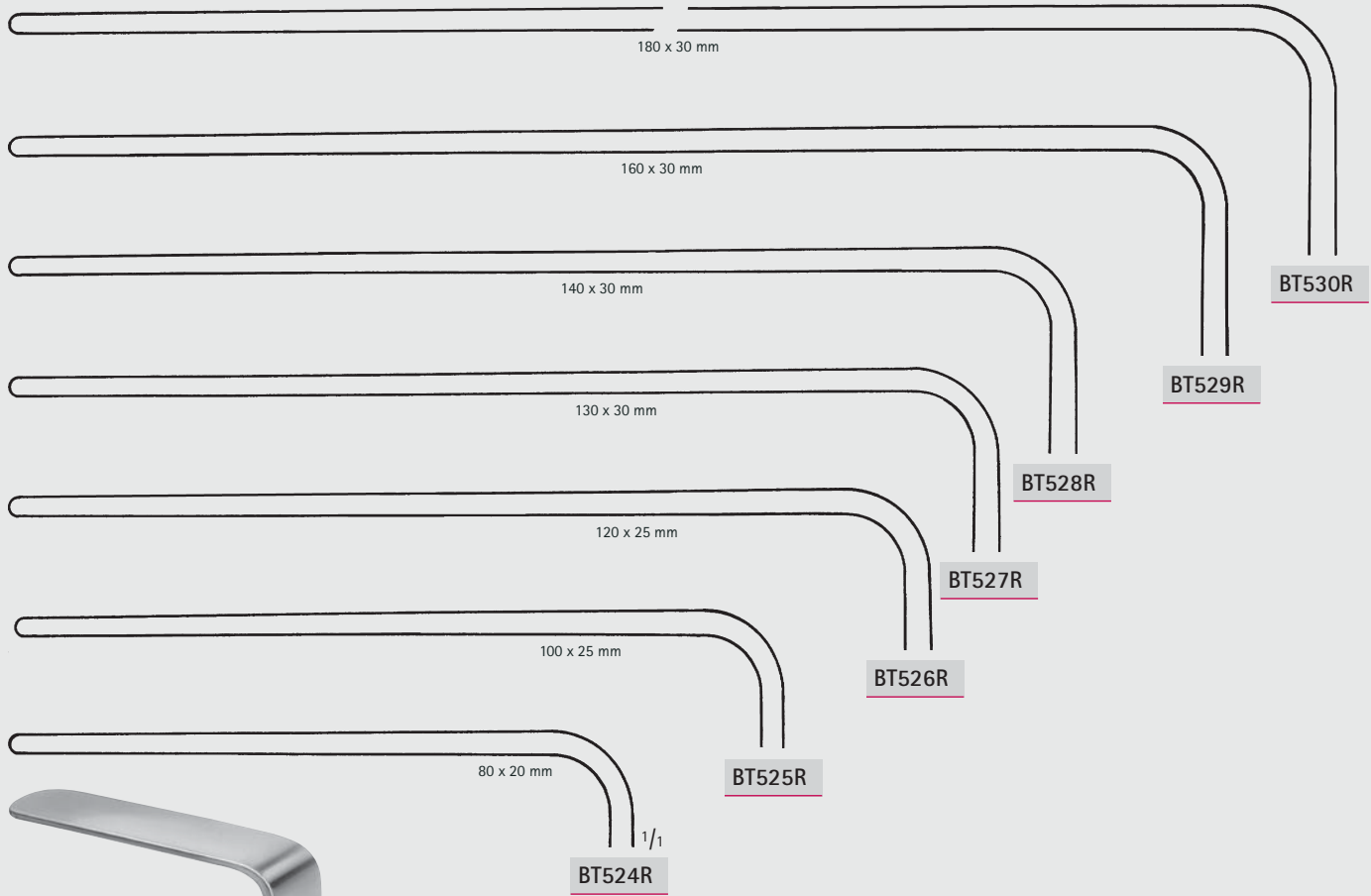

BRUNNER

BT524R-BT530R

$\frac{1}{2}$ 275 mm, 10 $\frac{3}{4}$ "

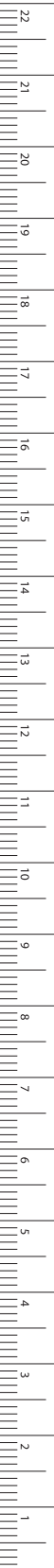

MILLIMETERS

Wundhaken – Wound Retractors

Varion-Wundhaken-System, DBP

Vario Retractor System, Germ. Fed. Patent

Maßangaben für Blattgrößen der Wundhaken

1. Zahl = Tiefe Beispiel: 25 x 38 mm

2. Zahl = Breite

Dimensions for blade size of retractors

1st number = depth Example: 25 x 38 mm

2nd number = width

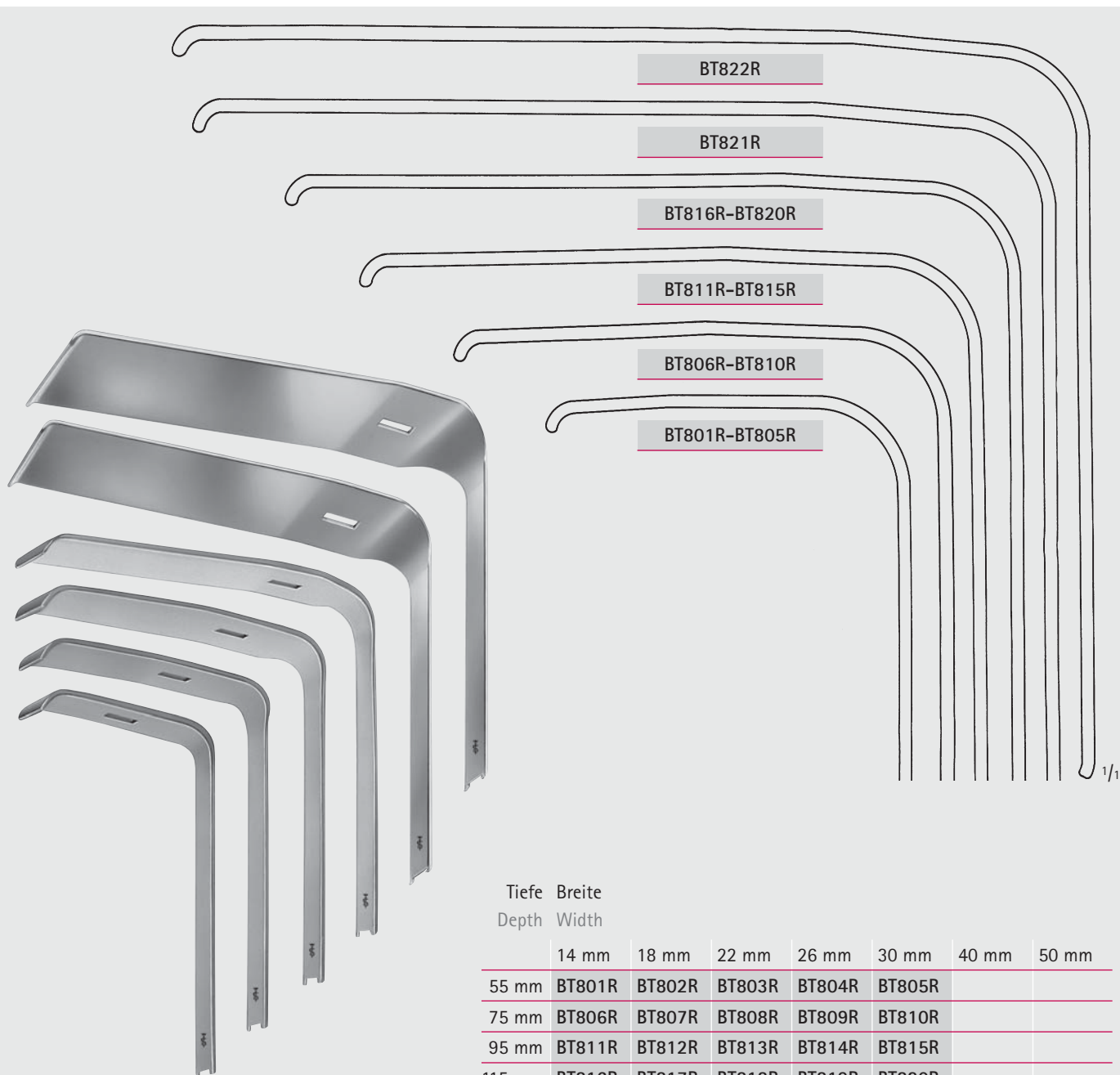
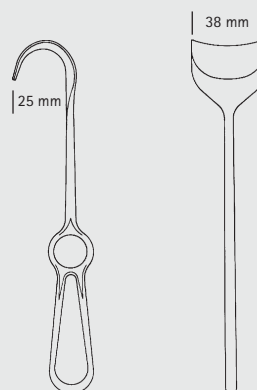

Tiefe Depth	Breite Width						
	14 mm	18 mm	22 mm	26 mm	30 mm	40 mm	50 mm
55 mm	BT801R	BT802R	BT803R	BT804R	BT805R		
75 mm	BT806R	BT807R	BT808R	BT809R	BT810R		
95 mm	BT811R	BT812R	BT813R	BT814R	BT815R		
115 mm	BT816R	BT817R	BT818R	BT819R	BT820R		
135 mm						BT821R	
145 mm							BT822R

Wundhakenblätter
passend auf die Handgriffe
BT799R und BT800R.

Retractor blades
for handles
BT799R and BT800R.

BT



Wundhaken – Wound Retractors

Wundhaken, Lungenspatel

Retractors, Lung Spatulas

Maßangaben für Blattgrößen der Wundhaken

1. Zahl = Tiefe Beispiel: 25 x 38 mm

2. Zahl = Breite

Dimensions for blade size of retractors

1st number = depth Example: 25 x 38 mm

2nd number = width

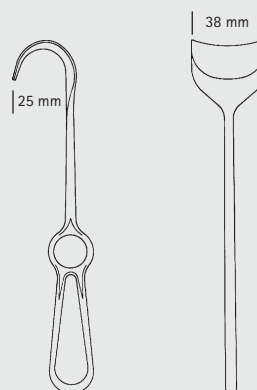

BT551R

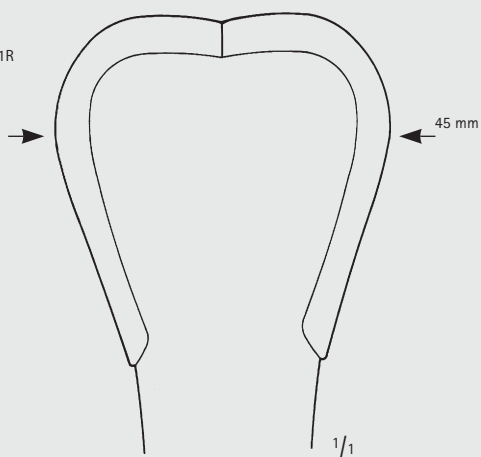

BT552R

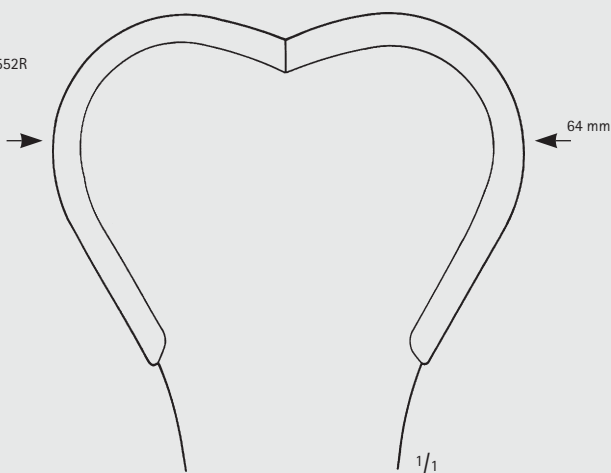

HARRINGTON

BT551R 123 x 45 mm

BT552R 123 x 64 mm

federnd

flexible

295 mm, 11 3/4"

BT





Wundhaken – Wound Retractors
Wundhaken, Lungenspatel
Retractors, Lung Spatulas

BT

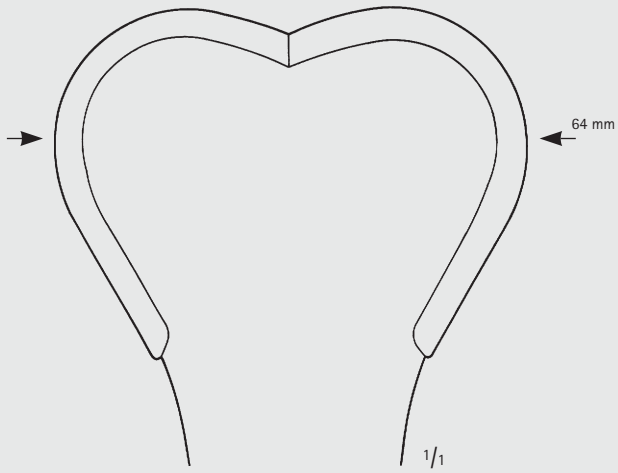

HARRINGTON-PEMBERTON

BT553R

175 x 64 mm

federnd

flexible

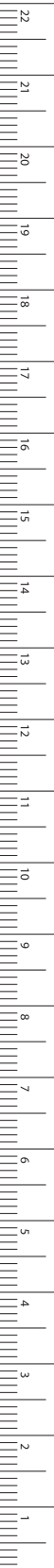

MILLIMETERS



Wundhaken – Wound Retractors
 Wundhaken, Lungenspatel
 Retractors, Lung Spatulas

BT

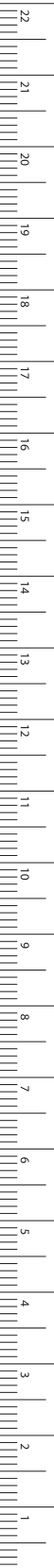
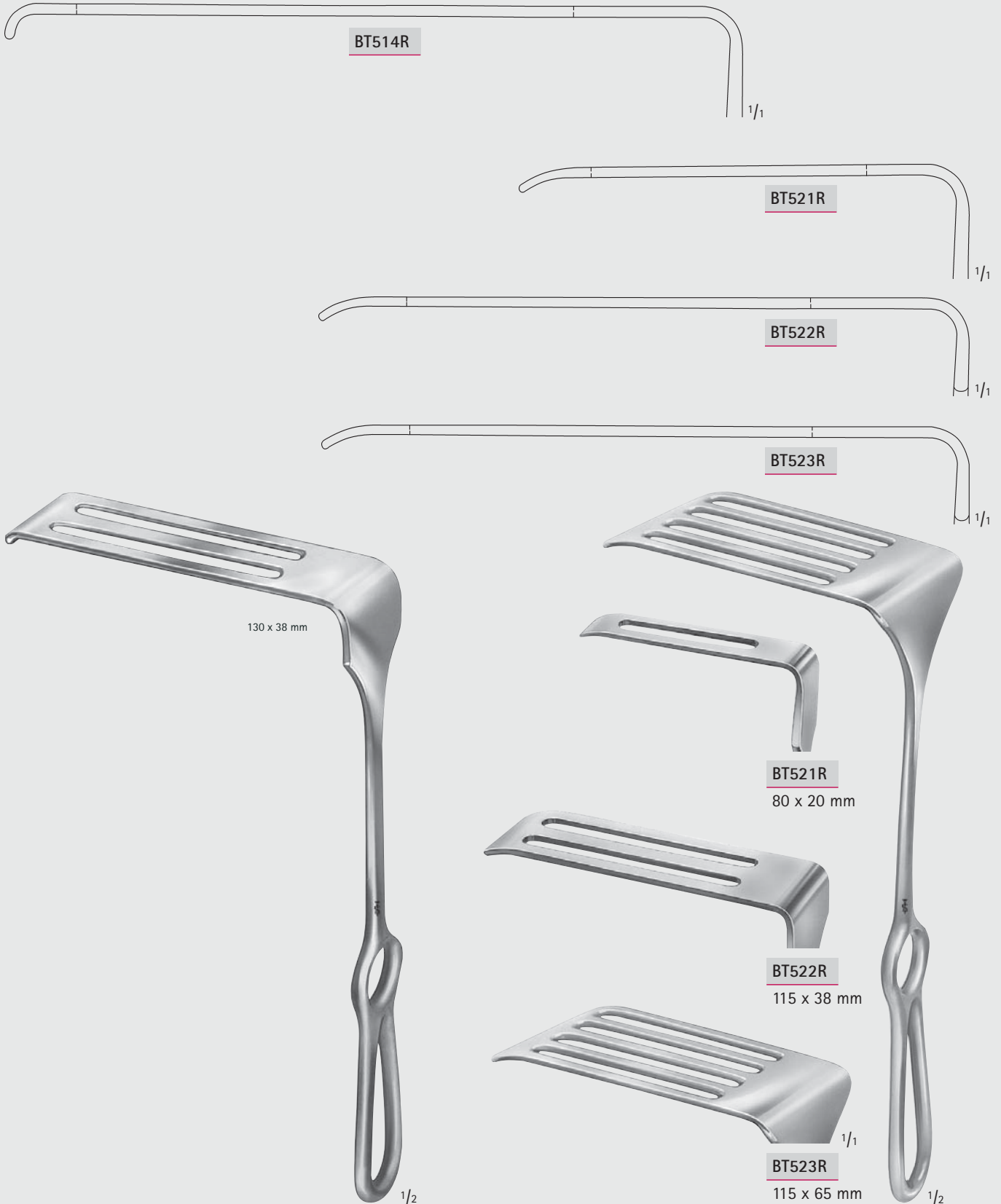

SAUERBRUCH

BT514R

260 mm, 10 $\frac{1}{4}$ "

CORYLLOS

BT521R–BT523R

255 mm, 10"

Wundhaken – Wound Retractors

Scapula Haken

Scapula Retractor

Maßangaben für Blattgrößen der Wundhaken

1. Zahl = Tiefe Beispiel: 25 x 38 mm

2. Zahl = Breite

Dimensions for blade size of retractors

1st number = depth Example: 25 x 38 mm

2nd number = width

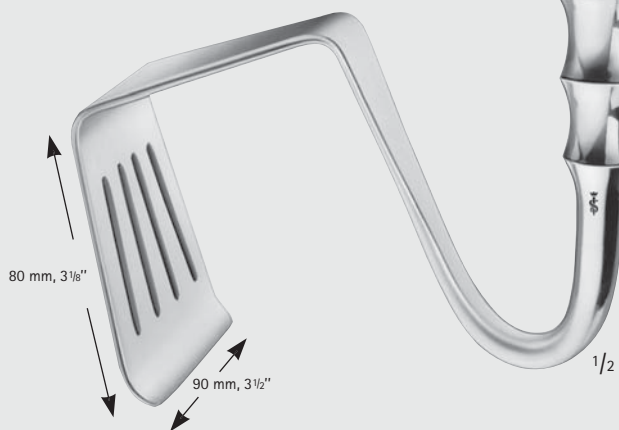
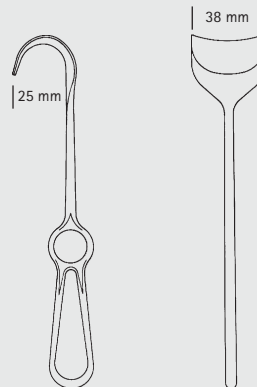

DAVIDSON

BT531R

195 mm, 7 3/4"

BT





Wundhaken – Wound Retractors

Wundhaken
Retractors

BT



Wundhaken – Wound Retractors

Wundhaken
Retractors

Maßangaben für Blattgrößen der Wundhaken

1. Zahl = Tiefe Beispiel: 25 x 38 mm

2. Zahl = Breite

Dimensions for blade size of retractors

1st number = depth Example: 25 x 38 mm

2nd number = width

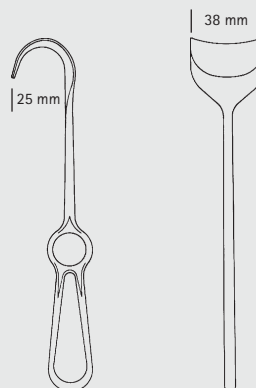

MD076

10 mm

160 mm

6 1/4"

MD077

13 mm

180 mm

7"

HASSON

MD076-MD077

BT





Wundhaken – Wound Retractors

Wundhaken
Retractors

BT

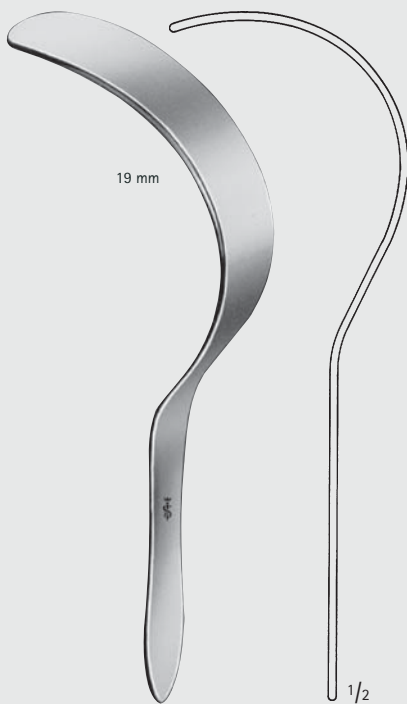

DEAVER

BT600R

180 mm, 7"
Fig. 000



DEAVER

BT601R

215 mm, 8 1/2"
Fig. 00



DEAVER

BT606R

235 mm, 9 1/4"
Fig. 0

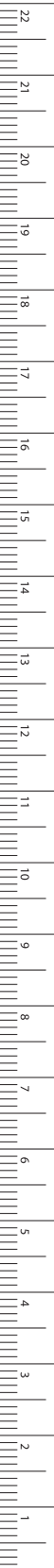

MILLIMETERS

Wundhaken – Wound Retractors

Wundhaken Retractors

Maßangaben für Blattgrößen der Wundhaken

1. Zahl = Tiefe Beispiel: 25 x 38 mm

2. Zahl = Breite

Dimensions for blade size of retractors

1st number = depth Example: 25 x 38 mm

2nd number = width

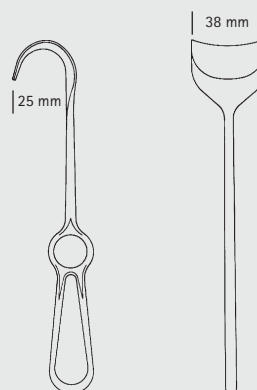

DEAVER

BT602R

Fig. 1
300 mm, 12"



DEAVER

BT603R

Fig. 2
315 mm, 12 1/2"

BT





Wundhaken – Wound Retractors

Wundhaken
Retractors

BT



DEAVER

BT607R

Fig. 2 1/2
365 mm, 14 1/2"



DEAVER

BT604R

Fig. 3
300 mm, 12"

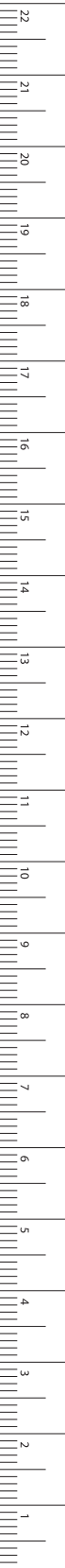

Wundhaken – Wound Retractors

Wundhaken

Retractors

Maßangaben für Blattgrößen der Wundhaken

1. Zahl = Tiefe Beispiel: 25 x 38 mm

2. Zahl = Breite

Dimensions for blade size of retractors

1st number = depth Example: 25 x 38 mm

2nd number = width

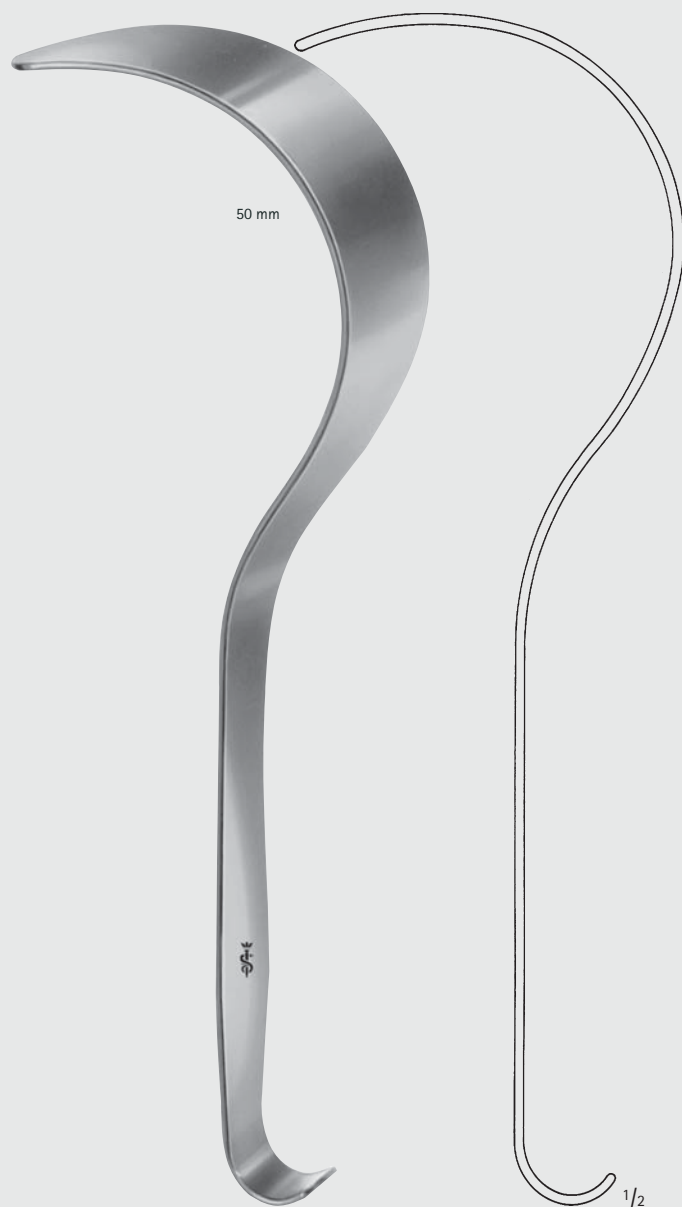
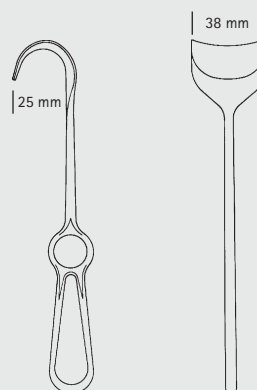

DEAVER

BT605R

Fig. 4

310 mm, 12 1/4"

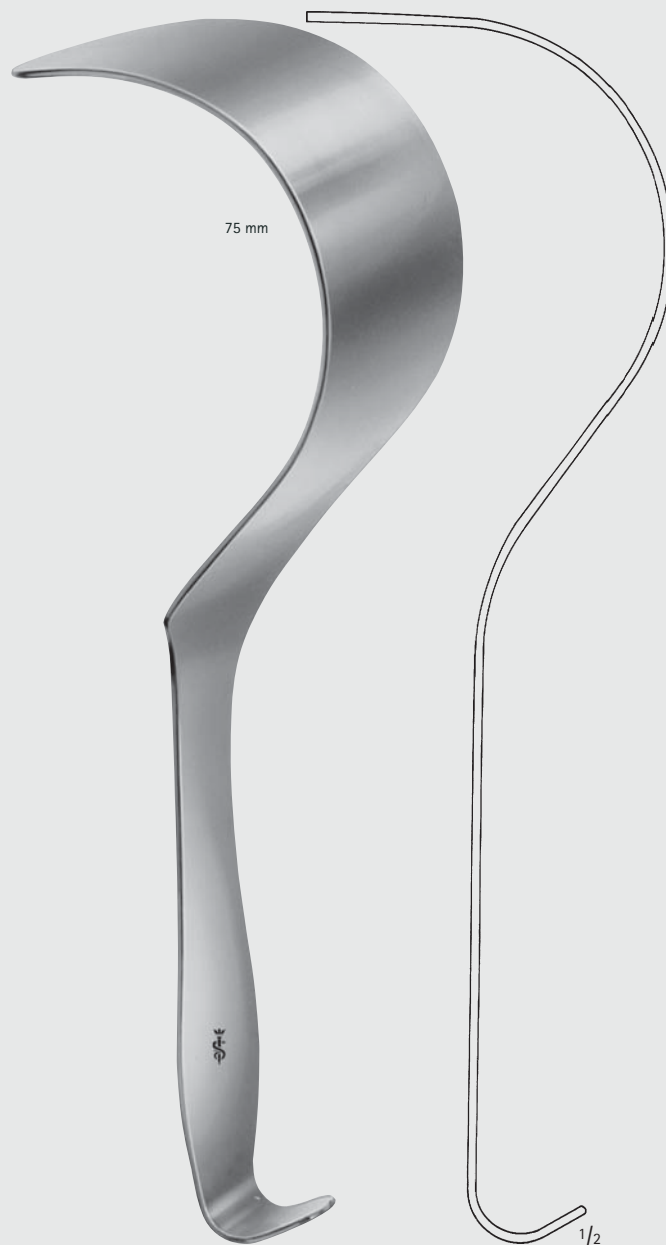

DEAVER

BT608R

Fig. 5

320 mm, 12 3/4"

BT





Wundhaken – Wound Retractors

Wundhaken
Retractors

BT



DEAVER

BT611R

Fig. 1
310 mm, 12 1/4"



DEAVER

BT613R

Fig. 3
310 mm, 12 1/4"

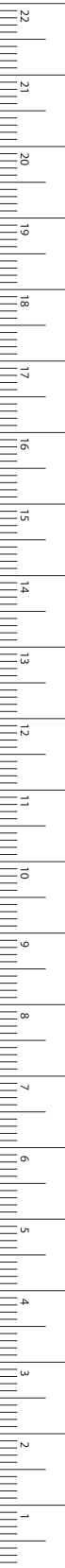

MILLIMETERS

Wundhaken – Wound Retractors

Wundhaken

Retractors

Maßangaben für Blattgrößen der Wundhaken

1. Zahl = Tiefe Beispiel: 25 x 38 mm

2. Zahl = Breite

Dimensions for blade size of retractors

1st number = depth Example: 25 x 38 mm

2nd number = width

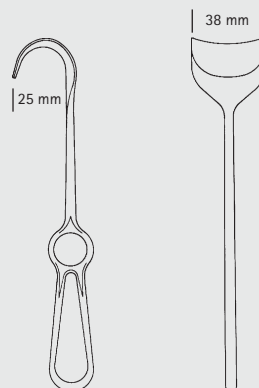

DEAVER

BT614R

Fig. 4
305 mm, 12"



DEAVER

BT615R

Fig. 5
310 mm, 12 1/4"

BT





Wundhaken – Wound Retractors

Wundhaken
Retractors

BT

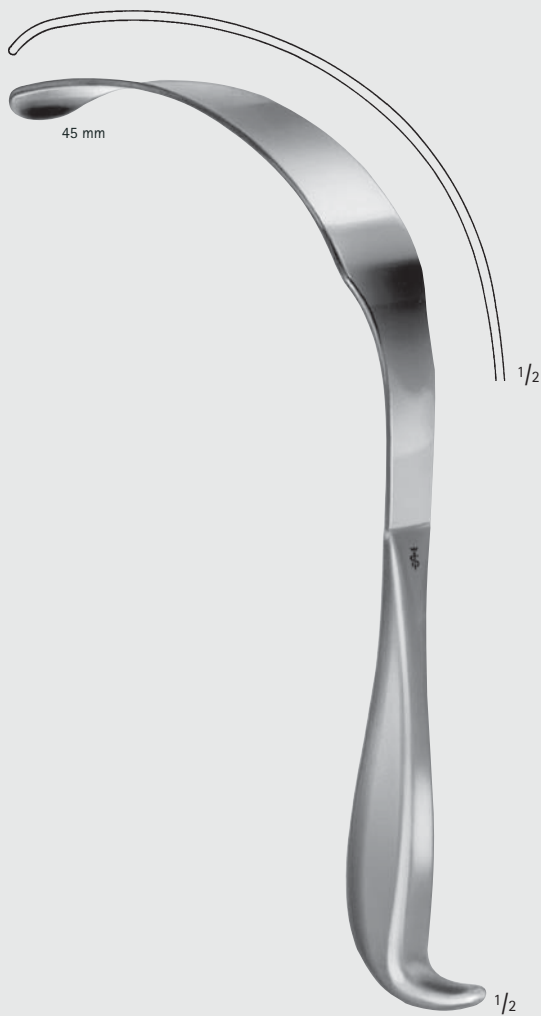

LERICHE

BT730R

255 mm, 10"



LERICHE

BT732R

275 mm, 10 3/4"

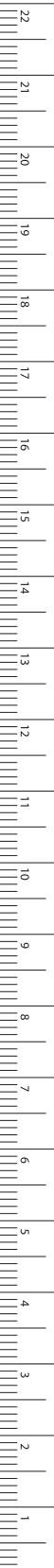

MILLIMETERS

Wundhaken – Wound Retractors

Wundhaken Retractors

Maßangaben für Blattgrößen der Wundhaken

1. Zahl = Tiefe Beispiel: 25 x 38 mm

2. Zahl = Breite

Dimensions for blade size of retractors

1st number = depth Example: 25 x 38 mm

2nd number = width

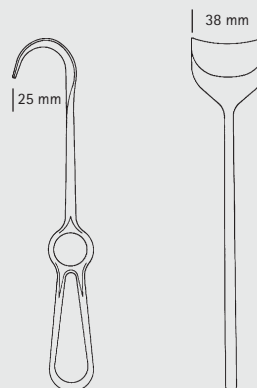

KÜMMEL

BT740R

biegsam

malleable

285 mm, 11 1/4"

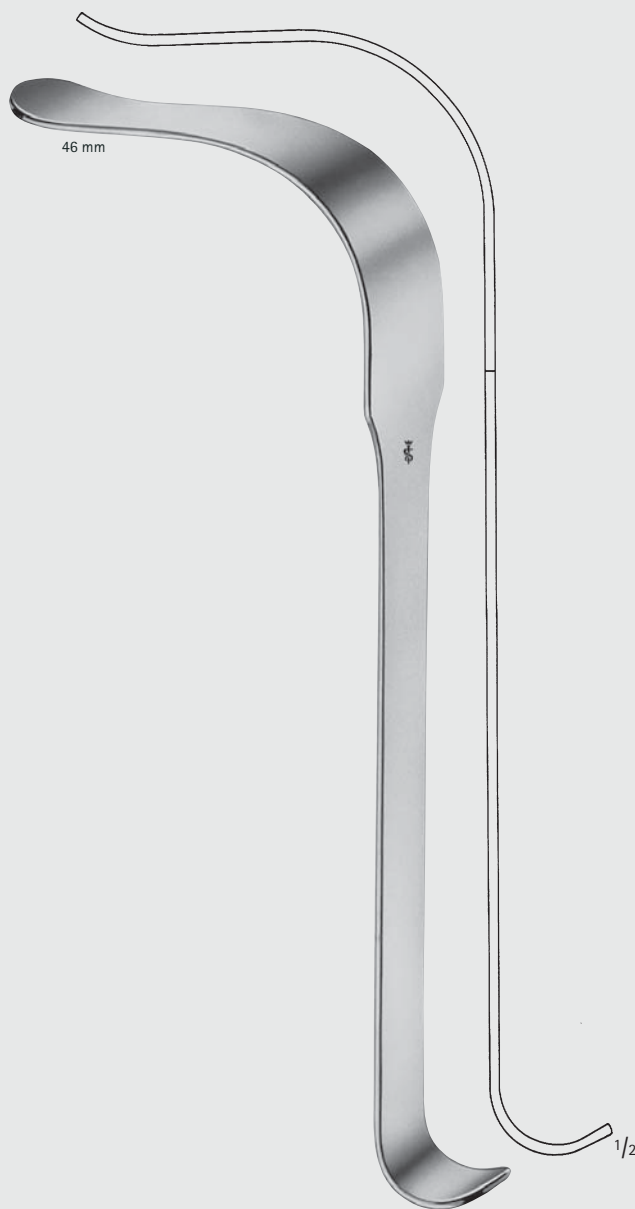

KÖRTE

BT742R

300 mm, 12"

BT





Wundhaken – Wound Retractors

Wundhaken für Eingriffe in der Tiefe (Bauchdeckenhaken)
Retractors for Deep Surgery (Abdominal Retractors)

BT

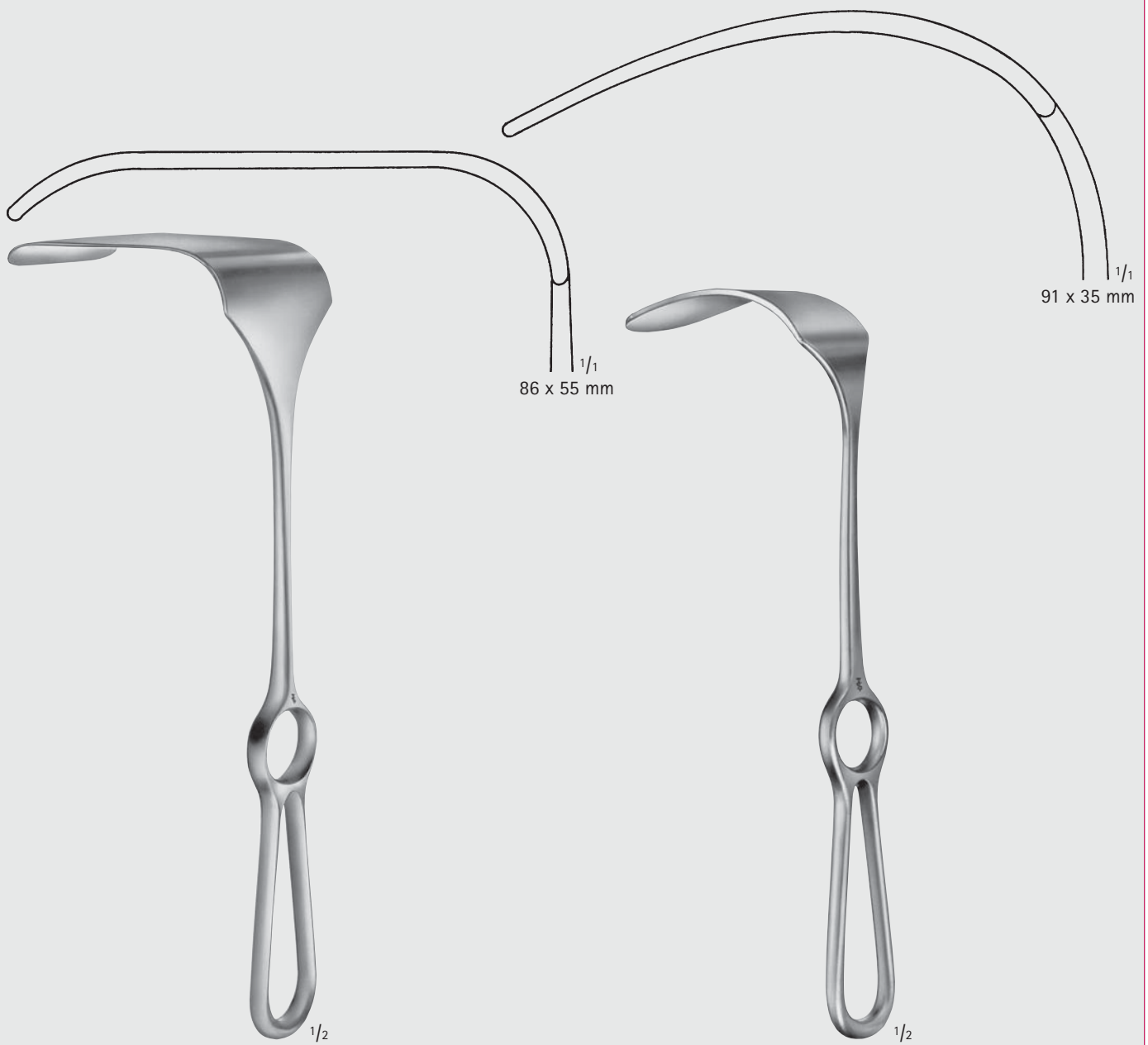

MIKULICZ

BT618R

255 mm, 10"

MIKULICZ

BT621R

240 mm, 9 1/2"

MILLIMETERS

Wundhaken – Wound Retractors

Wundhaken für Eingriffe in der Tiefe (Bauchdeckenhaken)

Retractors for Deep Surgery (Abdominal Retractors)

Maßangaben für Blattgrößen der Wundhaken

1. Zahl = Tiefe Beispiel: 25 x 38 mm

2. Zahl = Breite

Dimensions for blade size of retractors

1st number = depth Example: 25 x 38 mm

2nd number = width

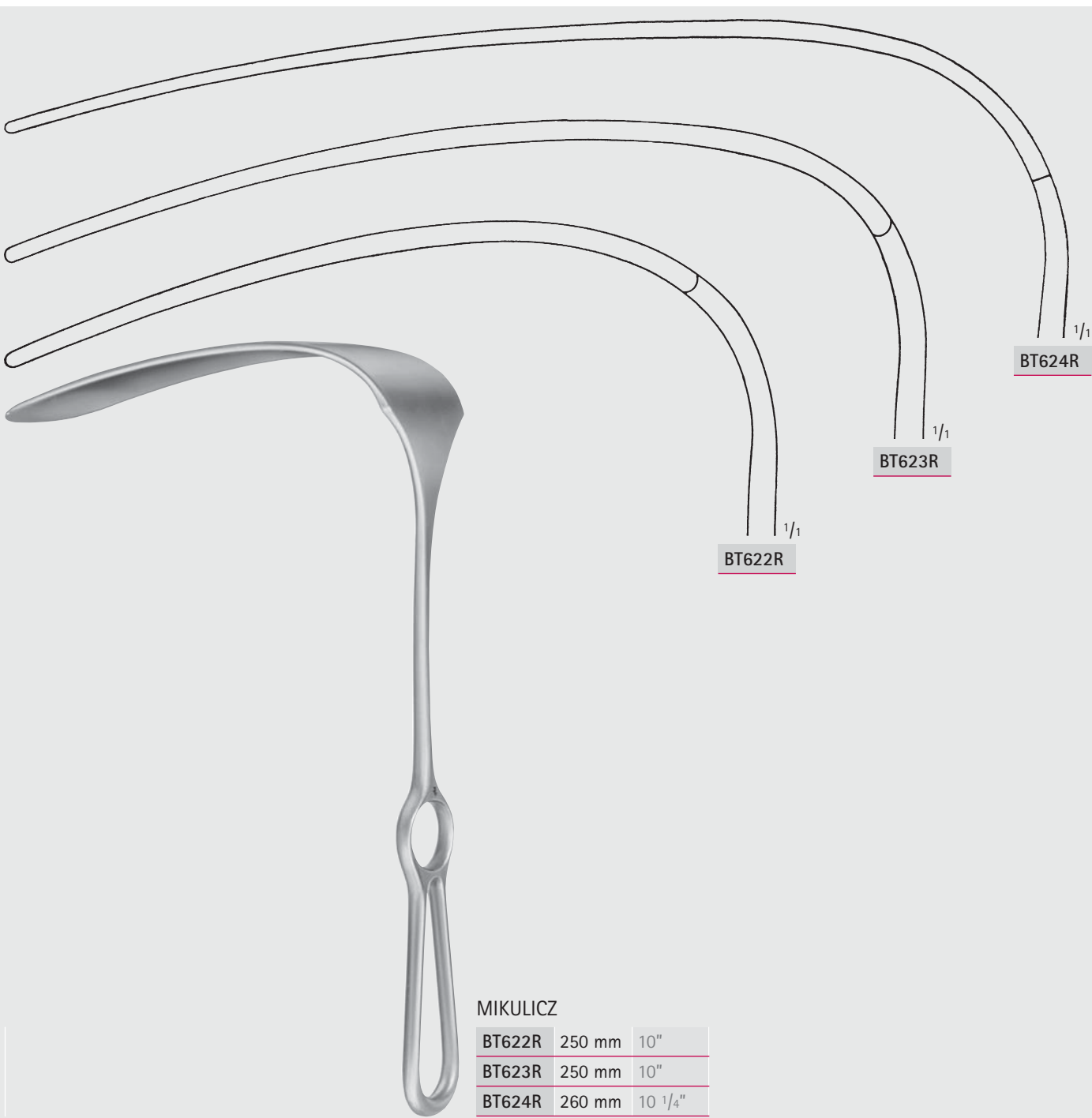
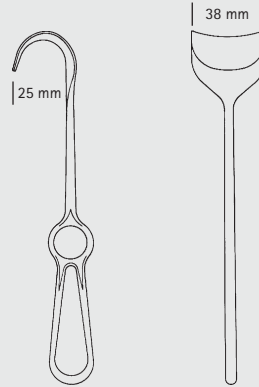

MIKULICZ

BT622R	250 mm	10"
BT623R	250 mm	10"
BT624R	260 mm	10 1/4"

BT

INCHES



Wundhaken – Wound Retractors

Wundhaken für Eingriffe in der Tiefe (Bauchdeckenhaken)
Retractors for Deep Surgery (Abdominal Retractors)

BT

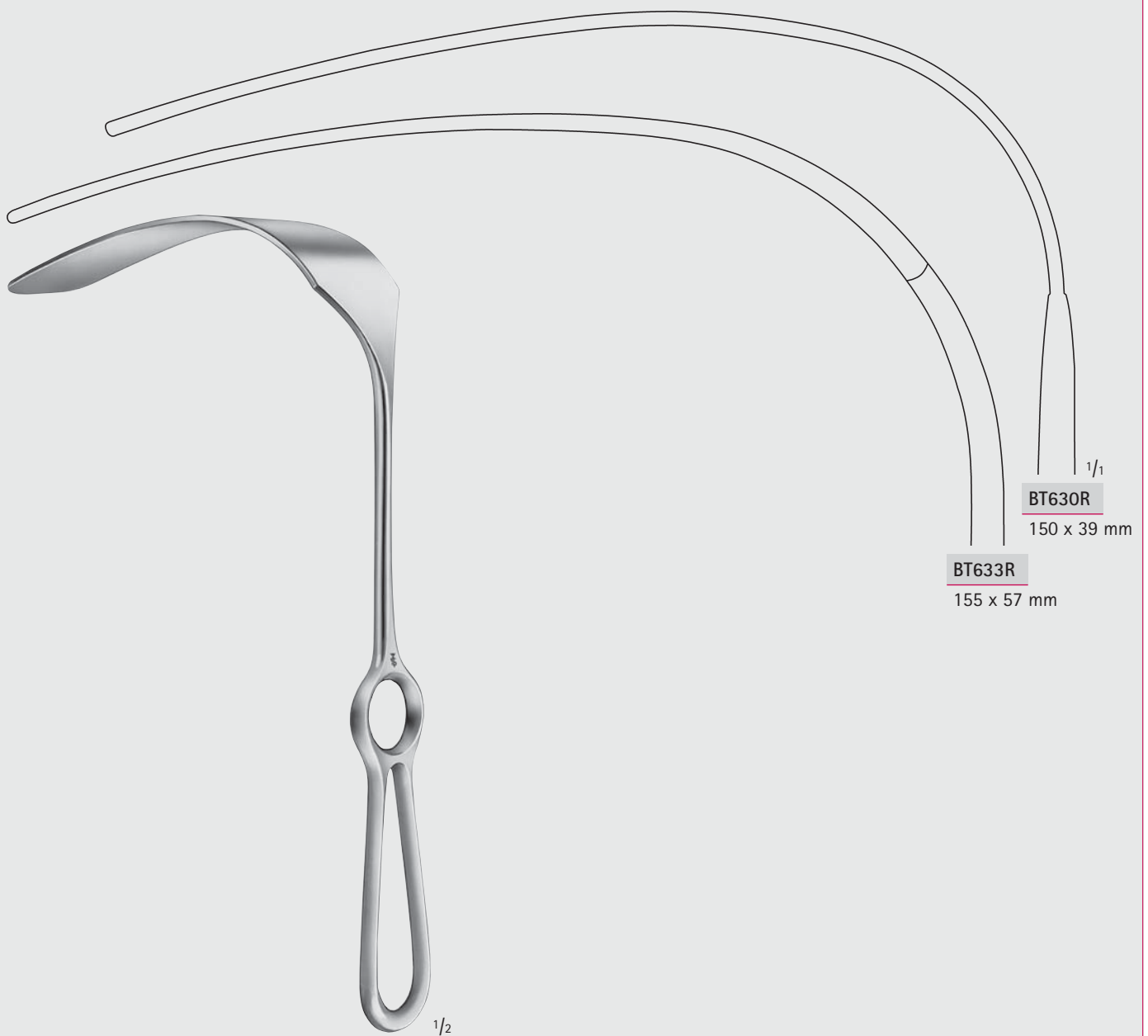

KELLY

BT630R-BT633R

260 mm, 10 1/4"

MILLIMETERS

Wundhaken – Wound Retractors

Pelvishaken

Pelvis Retractors

Maßangaben für Blattgrößen der Wundhaken

1. Zahl = Tiefe Beispiel: 25 x 38 mm

2. Zahl = Breite

Dimensions for blade size of retractors

1st number = depth Example: 25 x 38 mm

2nd number = width

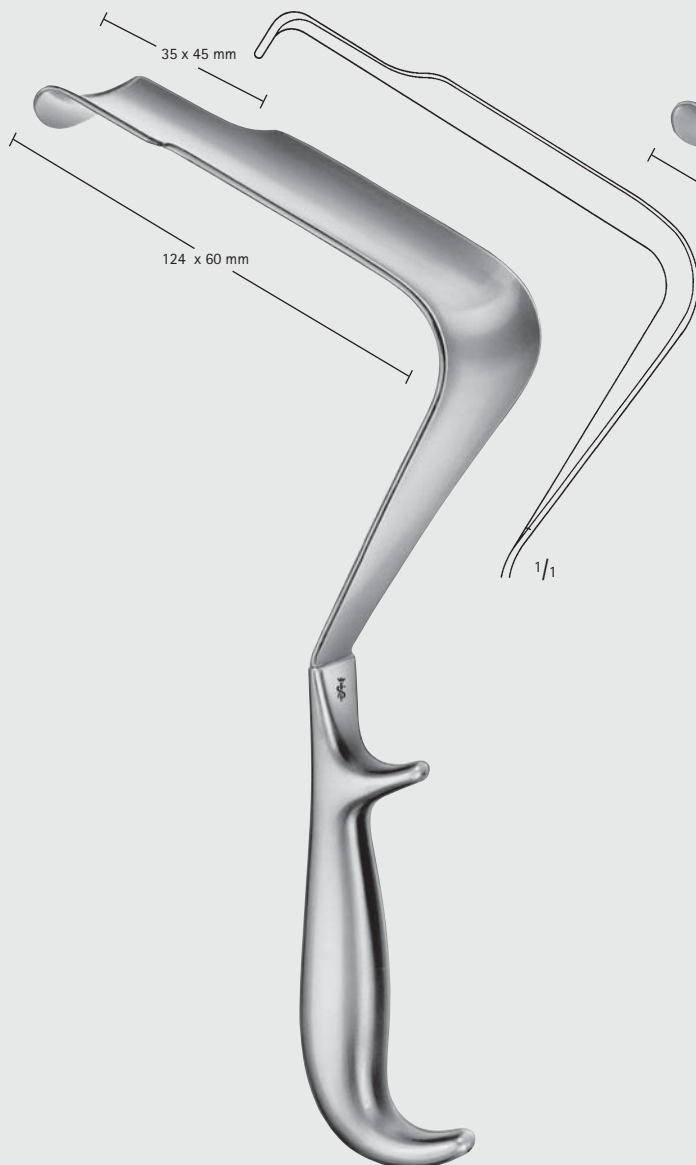
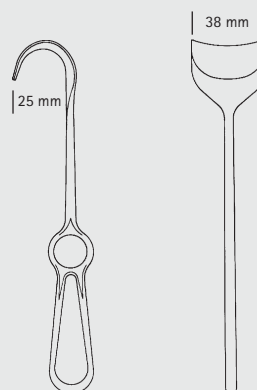

ST. MARKS

BT670R

290 mm, 11 1/2"

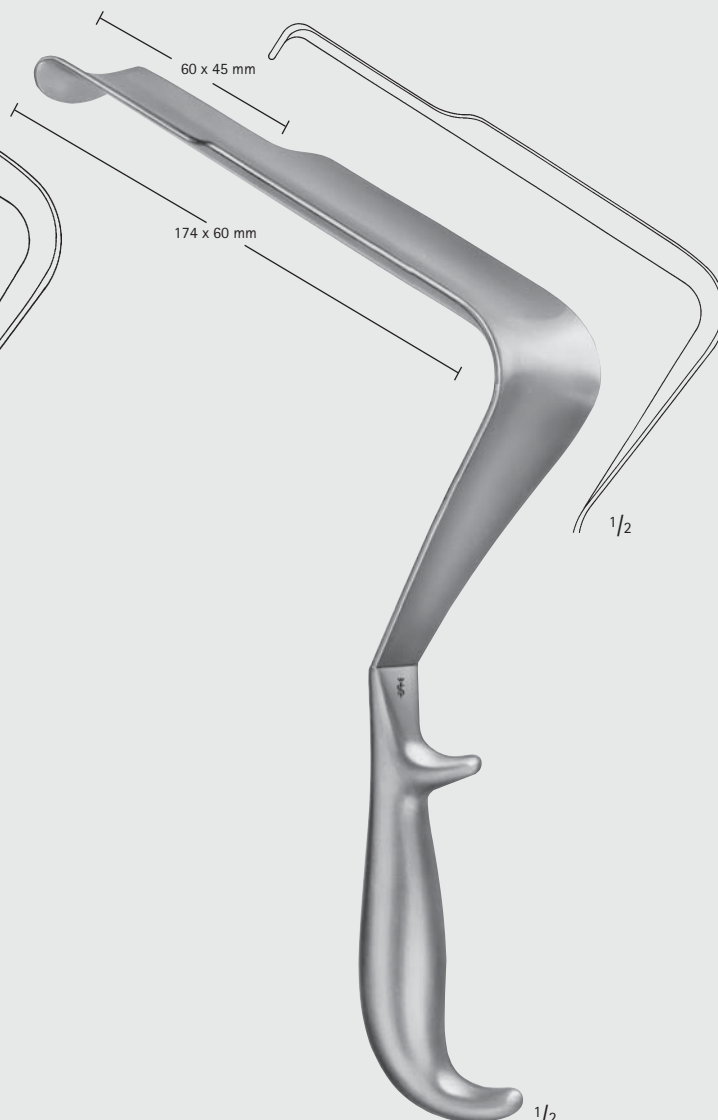

ST. MARKS

BT672R

330 mm, 13 1/8"

BT



INCHES



Wundhaken – Wound Retractors
Pelvishaken
Pelvis Retractors

BT

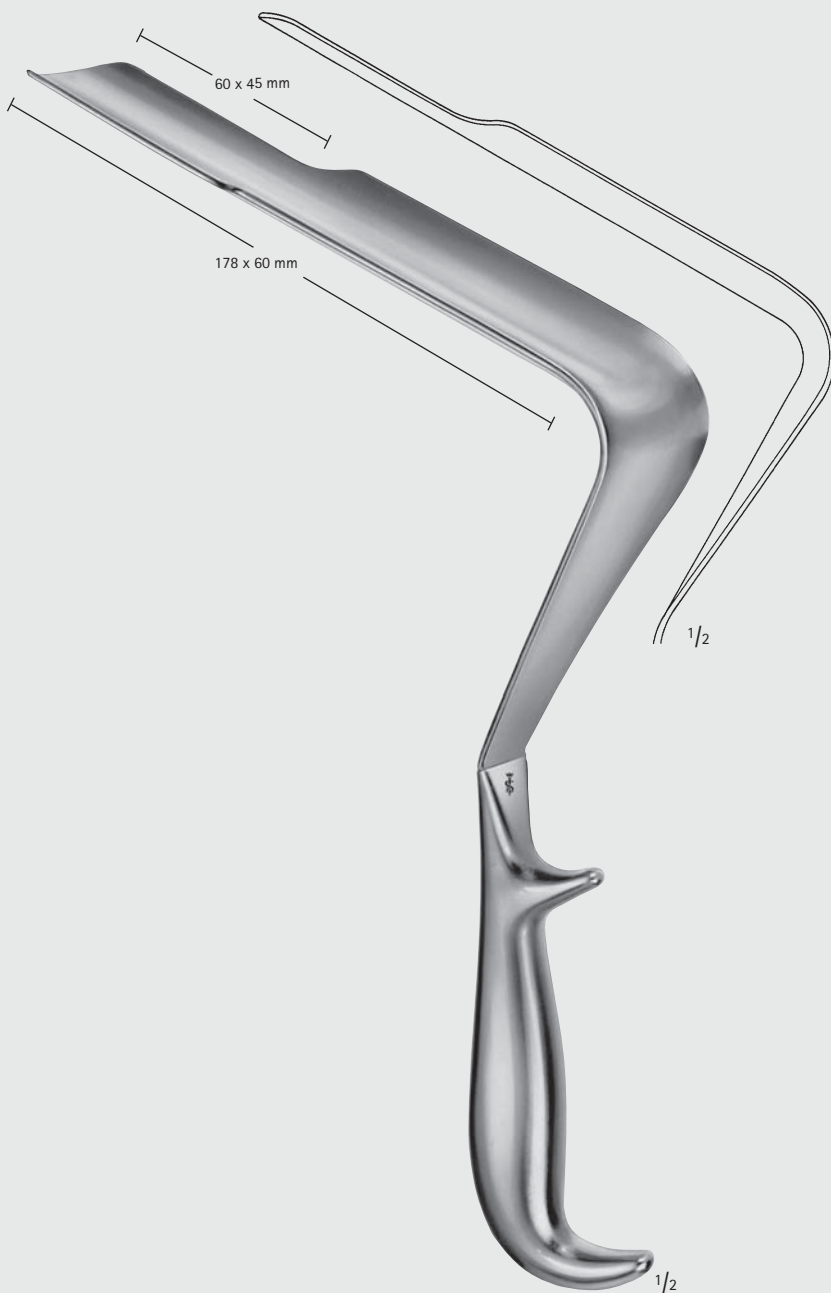

ST. MARKS

BT674R

330 mm, 13 1/8"

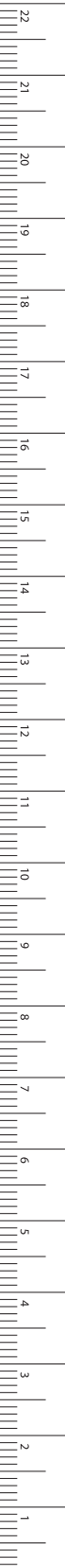

Wundhaken – Wound Retractors

Wundhaken
Retractors

Maßangaben für Blattgrößen der Wundhaken

1. Zahl = Tiefe Beispiel: 25 x 38 mm

2. Zahl = Breite

Dimensions for blade size of retractors

1st number = depth Example: 25 x 38 mm

2nd number = width



MÜLLER

BT626R

270 mm, 10 ³/₄"

INCHES



Wundhaken – Wound Retractors

Wundhaken, Bauchdeckenhaken
Retractors, Abdominal Retractors

BT



TUDOR-EDWARDS

BT500R

205 mm, 8"

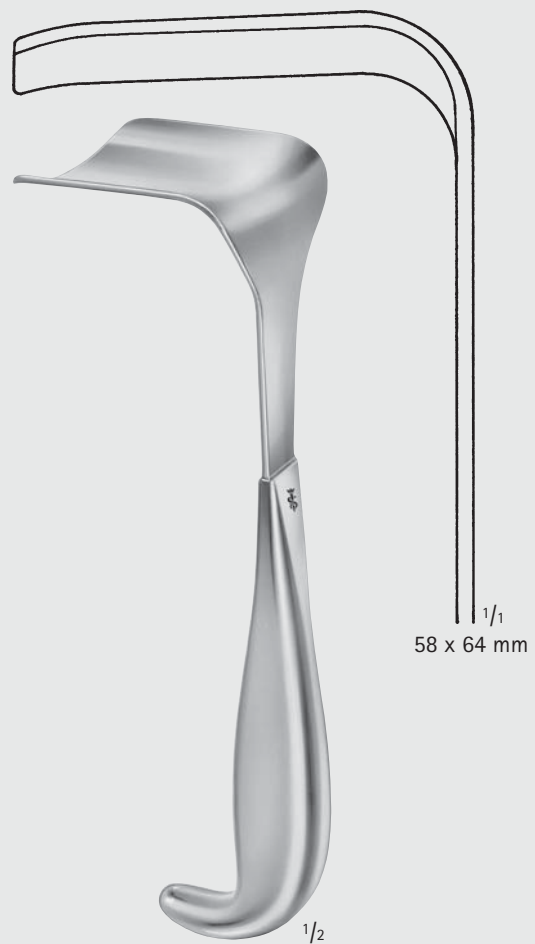

TUFFIER

BT617R

215 mm, 8 1/2"



MILLIMETERS



Wundhaken – Wound Retractors
 Bauch- und Darmspatel
 Abdominal- and Intestinal Spatulas

BT



KADER

BT746R 30 mm

BT747R 40 mm

270 mm, 10 3/4"

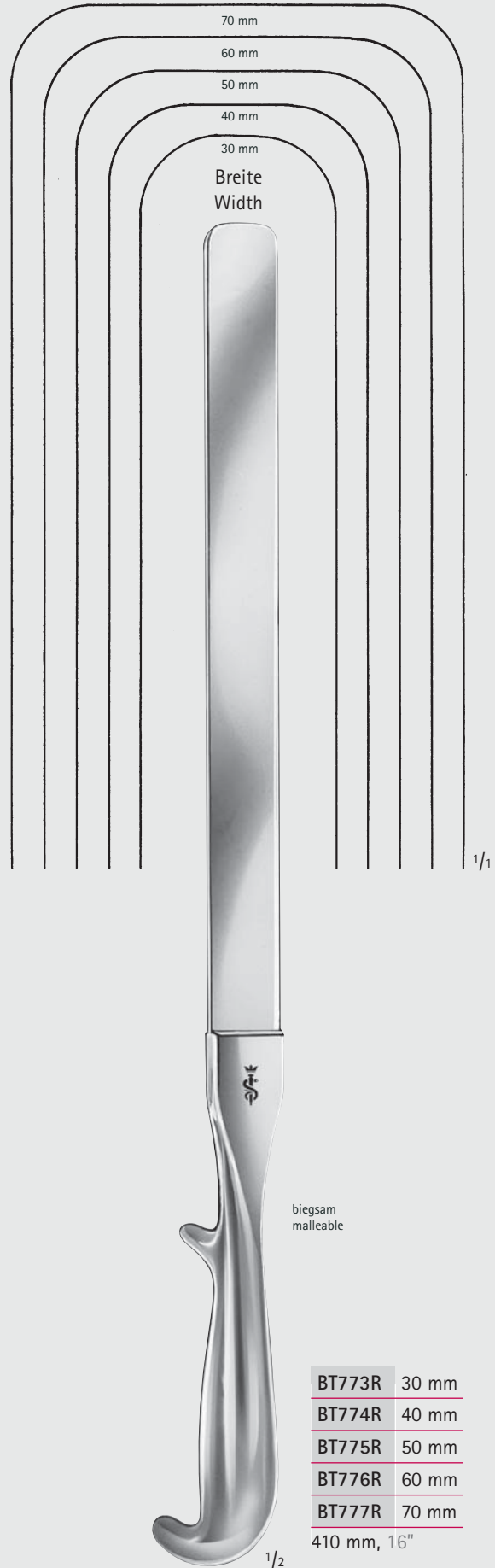

biegsam
malleable

BT773R 30 mm

BT774R 40 mm

BT775R 50 mm

BT776R 60 mm

BT777R 70 mm

410 mm, 16"

MILLIMETERS

Wundhaken – Wound Retractors

Prostata- und Urethra-Retraktoren

Prostate- and Urethral Retractors

BT



1/2

BT680R

Prostata-Retraktor

Prostate retractor

360 mm, 14 3/8"



1/2

BT681R

Urethra-Retraktor

Urethral retractor

390 mm, 15 1/2"

Wundspreizer, Bauchdeckenhalter – Self-Retaining Retractors, Abdominal Retractors

Blasenwundspreizer

Bladder Retractors



KUGELSCHNELLVERSCHLUSS
BALL SNAP CLOSURE

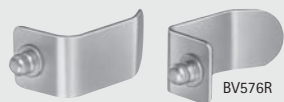

BV576R



BV577R

MILLIN

BV580R

Blasenwundspreizer komplett,
bestehend aus:

- BV575R Sperrer allein
- BV576R Blätter 57 x 25 mm
- BV577R Blätter 82 x 25 mm
- BV578R Mittelblatt 105 x 45 mm

Bladder retractor complete,
consisting of:

- BV575R Spreader only
- BV576R Blades 57 x 25 mm
- BV577R Blades 82 x 25 mm
- BV578R Center blade 105 x 45 mm

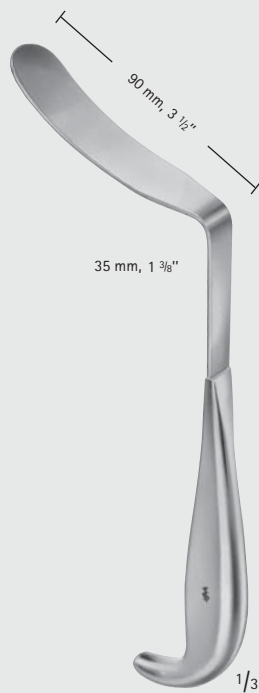

1/3

LEGUEU

BV928R

Blasenspatel

Bladder spatula

260 mm, 10 1/4"



Biopsie- und Kürettage-Instrumente – Biopsy Instruments and Curettes

Biopsieküretten, I.U.D.-Entfernungshaken
Biopsy Curettes, I.U.D. Removing Hook

ER

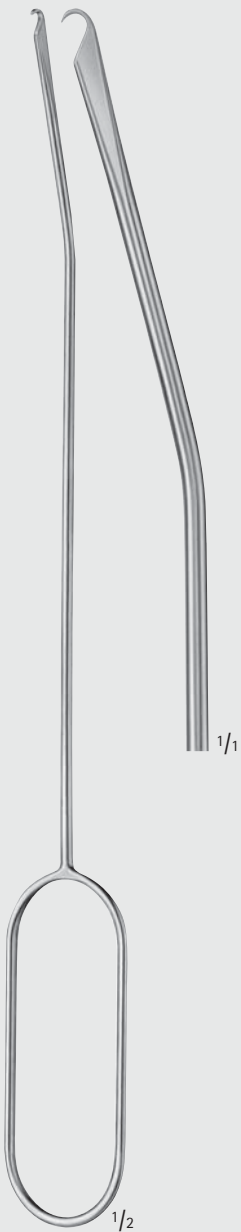

SAUNDERS

ER002R

I.U.D.-Entfernungshaken
I.U.D. Removing hook
320 mm, 12 1/2"



ASCH

ER005R

Sekretlöffel
Secretion scoop
200 mm, 8"

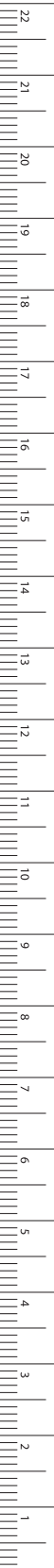

MILLIMETERS

Herz- und Gefäß-Chirurgie – Cardiovascular Surgery

Atriumhaken

Atrium Retractors

FB



45 x 48 mm

COOLEY

FB860R

rechts
right

270 mm, 10 3/4"



45 x 48 mm

COOLEY

FB861R

rechts, leicht gezahnt
right, slightly serrated

270 mm, 10 3/4"



25 x 46 mm

COOLEY

FB862R

links
left

280 mm, 11"



Herz- und Gefäß-Chirurgie – Cardiovascular Surgery
Atriumhaken
Atrium Retractors

FB

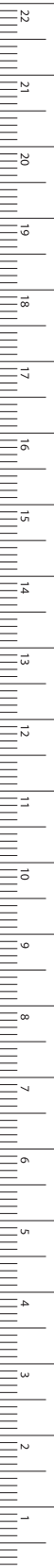

MILLIMETERS



45 x 30 mm

1/1

COOLEY MODIF. STRUCK

FB865R

leicht gezahnt
slightly serrated
265 mm, 10 1/2"



45 x 35 mm

1/1

COOLEY MODIF. STRUCK

FB866R

leicht gezahnt
slightly serrated
265 mm, 10 1/2"

Herz- und Gefäß-Chirurgie – Cardiovascular Surgery

Aortenklappenhaken

Aorta Value Retractors

FB

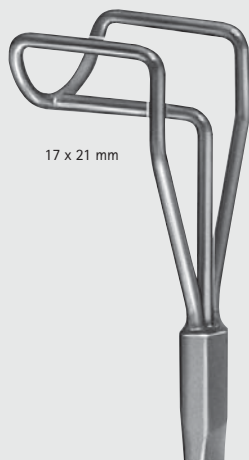

17 x 21 mm

FB971R

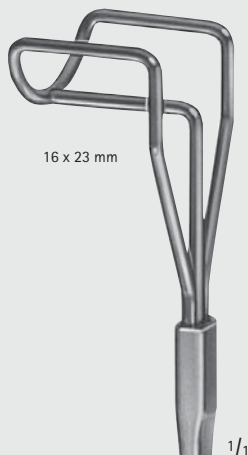

16 x 23 mm

FB972R

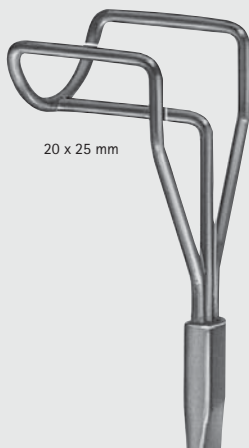

20 x 25 mm

FB973R

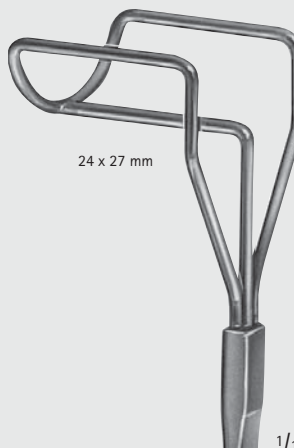

24 x 27 mm

FB974R

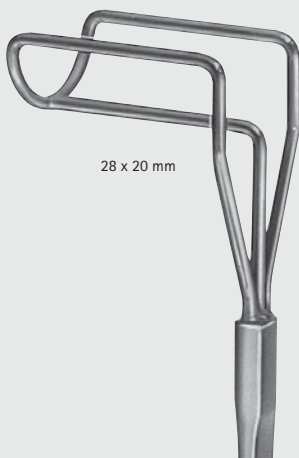

28 x 20 mm

FB975R

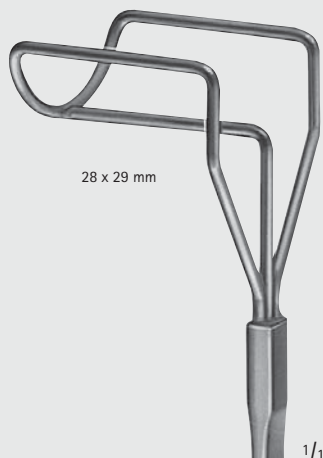

28 x 29 mm

FB976R



1/2

BOROWSKI

FB971R-FB976R

Schaft biegsam

Shaft malleable

270 mm, 10 3/4"

Knochenheber, Raspatorien, Scharfe Löffel – Bone Levers, Elevators, Bone Curettes

Retraktoren

Retractors

FK

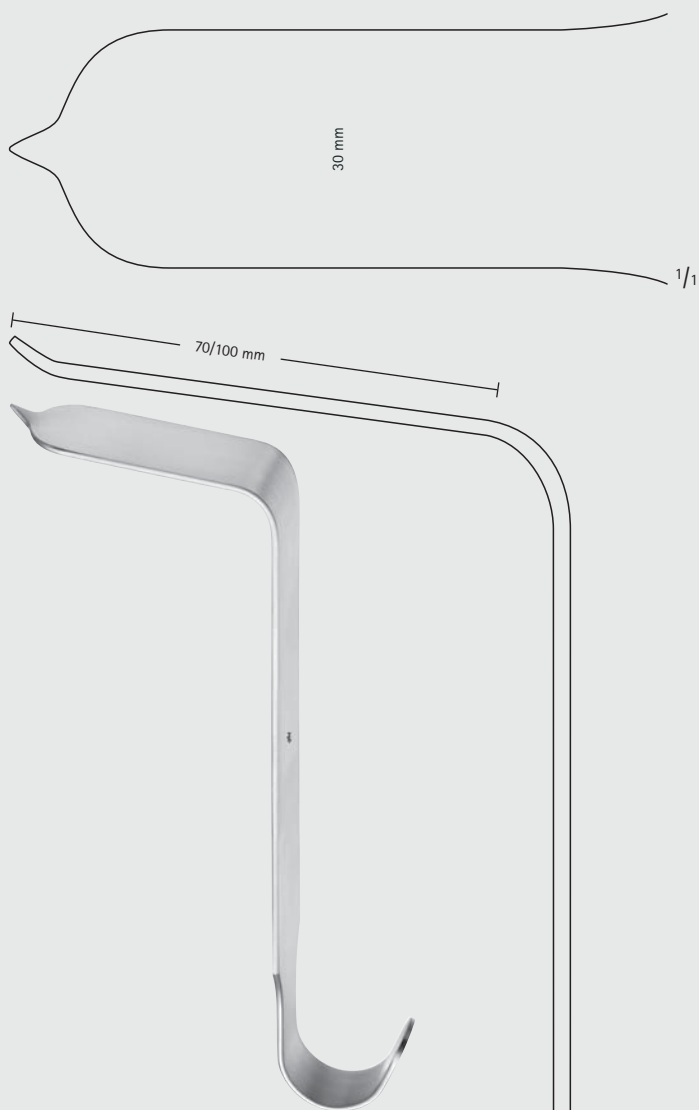

TAYLOR

Blattgröße:
Blade size:

BT501R	30 x 70 mm	185 mm	7 1/4"
BT502R	30 x 100 mm	200 mm	8"

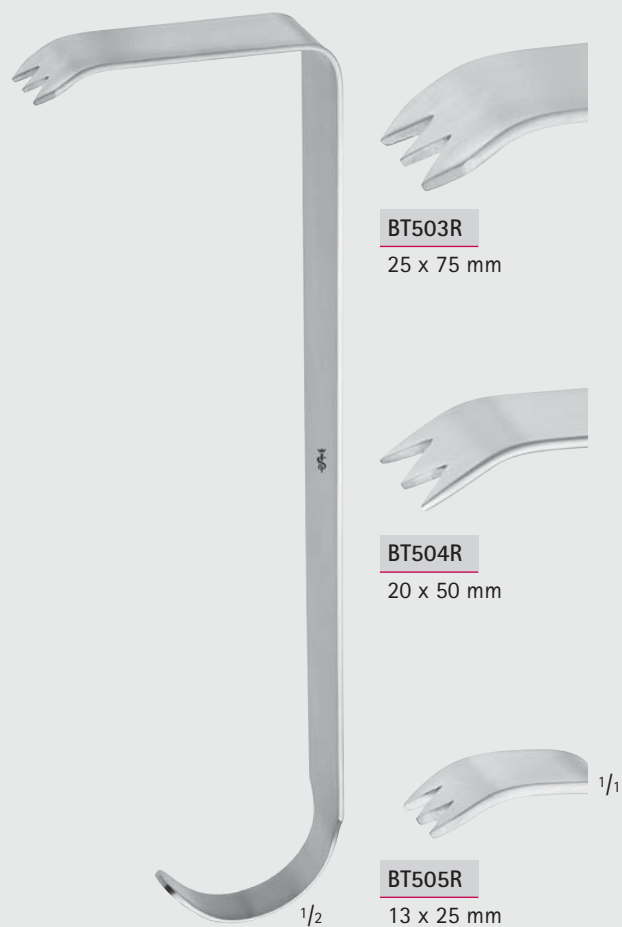

HIBBS

BT503R–BT505R

235 mm, 9 1/8"

Soft Tissue Retractors, Retractors, Cheek Retractors

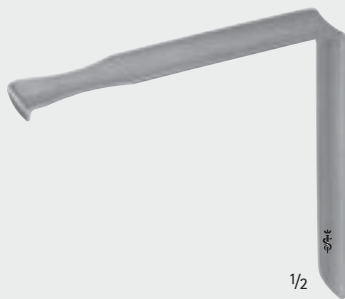

KAY (AUSTIN)
DO473R
Retractor

1/2



BOWDLER-HENRY
DO470R
Retractor
170 mm, 6 3/4"

1/2

Especially designed for upper impacted wisdom teeth. The design of the retractor enables the retraction of the cheek and mucoperiosteal flap as well as one hand simultaneous support of retractor and an additional instrument.



LASTER
DO472R
Cheek retractor
100 mm, 4"

1/2



WARD
DO471R
Cheek retractor
155 mm, 6"

1/2

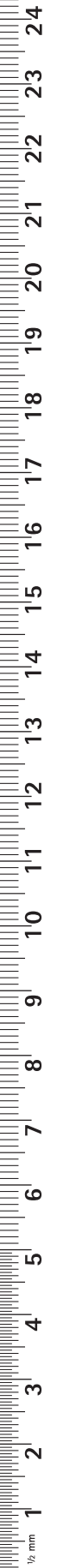



38 x 18 mm

1/1



1/2

BÜCHS
DO432R

Retractor for cheeks and soft tissue,
for surgery in the rear maxillo-dental
section
205 mm, 8"



1/2

BÜCHS
DX102R
ERGOPLANT
Soft tissue hook
200 mm, 8"



KIRSCH
DO440R – DO441R
210 mm, 8 1/4"



1/1

60 x 11 mm

DO440R

Diagonal cheek retractors for lateral region, particularly
useful for extraction of wisdom teeth for upper left and
bottom right



1/1

60 x 11 mm

DO441R

Diagonal cheek retractors for lateral region, particularly
useful for extraction of wisdom teeth for upper right and
bottom left

Soft Tissue Retractors, ERGOPLANT Soft Tissue Retractors, Diagonal Cheek Retractors, Retractors

10 x 42 mm

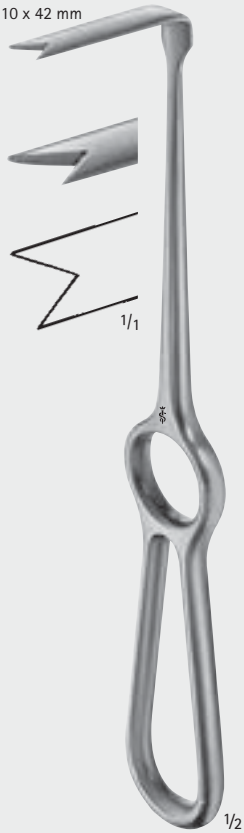

OBWEGESER
DO407R
Spina-nasalis retractor
215 mm, 8 1/2"

wide
DO420R 20 mm
DO421R 25 mm
DO422R 30 mm



DO420R - DO422R
Ramus retractor
165 mm, 6 1/2"

1/2

1/1

1/2

1/1

1/2

1/1

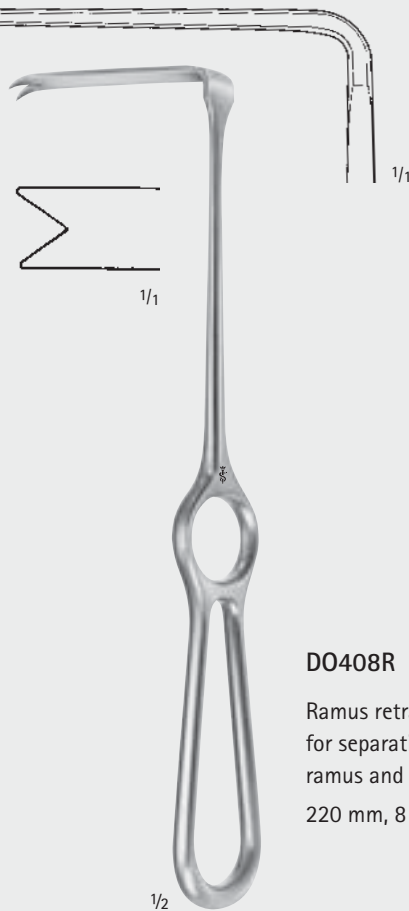

DO408R
Ramus retractor
for separation of
ramus and tissue
220 mm, 8 3/4"



DOCKHORN
DO438R - DO439R
Retractor
210 mm, 8 1/4"

1/2

1/1

1/2

1/1

1/2

1/1



WASSMUND
DO409R
Retractor
220 mm, 8 3/4"

1/2

1/1

1/2

1/1

1/2

1/1

DO438R
40 x 12 mm



DO439R
55 x 14 mm

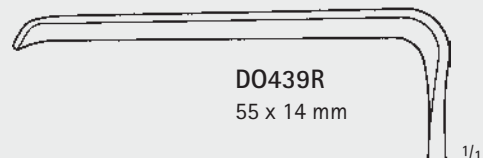



TESSIER
DO417R
Maxillary mobilizers
right
150 mm, 6"



TESSIER
DO418R
Maxillary mobilizers
left
150 mm, 6"



OBWEGESER
DO411R 8 mm
DO412R 10 mm
Channeled retractor
165 mm, 6 1/2"



OBWEGESER
DO410R
Chin retractor
155 mm, 6"

Cardiovascular

Bulldog and Micro Vessel Clamps



FB370R

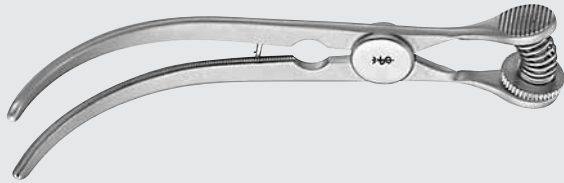

FB374R-FB376R

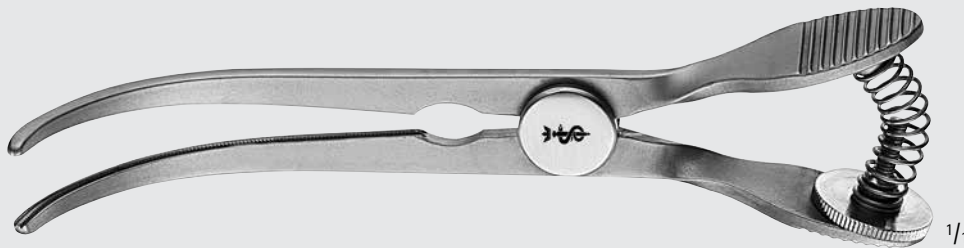

FB377R

GLOVER Atraumatic Bulldog Clamp

Catalog Number	Jaw	Jaw Length (mm)	Length (in.)
FB370R	STR	25	2
FB374R	CVD	20	1 1/2
FB375R	CVD	30	2 3/8
FB376R	CVD	45	3
FB377R	CVD	55	4 3/4

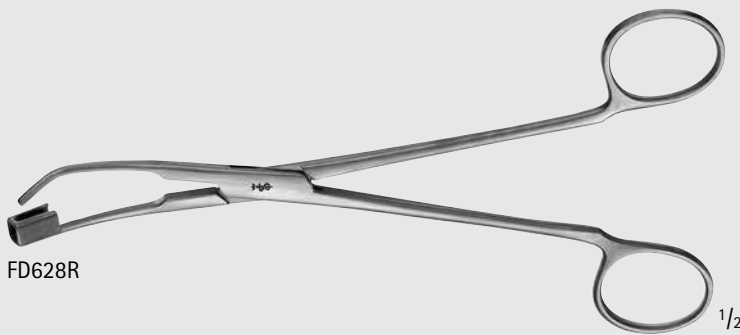

FD628R

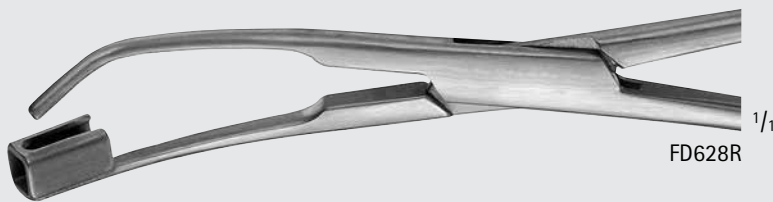

FD628R

SCHWARTZ Apply/Remove Forceps

Catalog Number	Length (in.)
FD628R	7 1/2



FD622R



FD623R



FD624R

SCHWARTZ Micro-Vessel Clamp, Cross-Serrated

Catalog Number	Jaw	Jaw Length (mm)	Closing Force	Length (in.)
FD622R	STR	8	400G	1
FD623R	25°	8	400G	1
FD624R	45°	8	400G	1

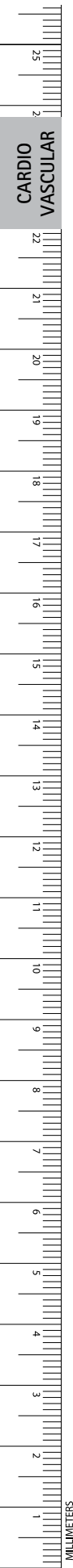

Cardiovascular

Retractors



FB923R-FB927R

1/2

COOLEY Atrium Retractor, Left

Catalog Number	Blade Size (mm)	Length (in.)
FB923R	25 x 20	9 5/8
FB924R	25 x 25	9 5/8
FB925R	25 x 30	9 5/8
FB926R	25 x 35	9 5/8
FB927R	25 x 45	9 5/8



25 x 20 mm

FB923R

1/1



25 x 25 mm

FB924R

1/1

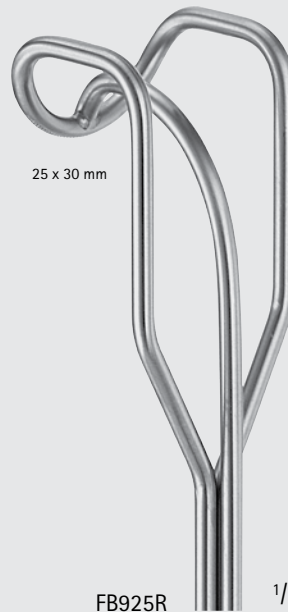

25 x 30 mm

FB925R

1/1

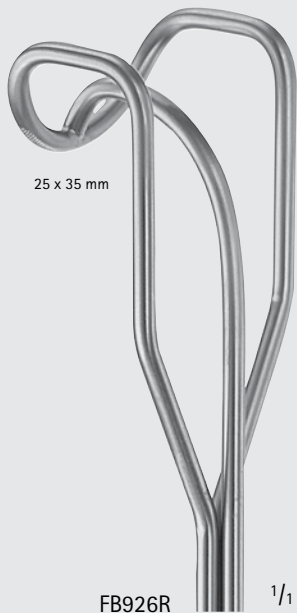

25 x 35 mm

FB926R

1/1

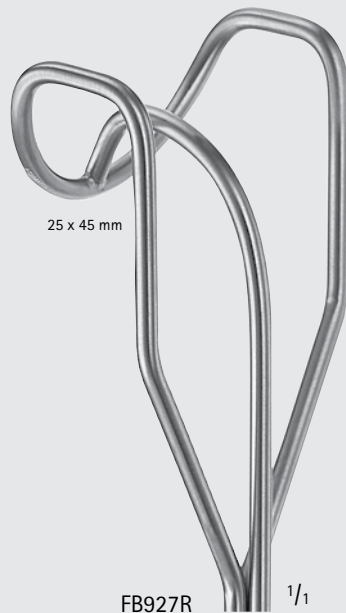

25 x 45 mm

FB927R

1/1



CARDIO
VASCULAR

INCHES

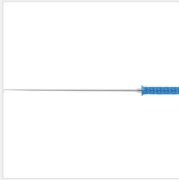

FC352R

VALVE XS Nerve And Vessel Retractor, 385 mm (15 1/4"), working length: 275 mm (10 3/4), tip length: 9 mm, non-sterile, reusable



Product search type	Nerve And Vessel Retractor
Brand name	VALVE XS
Aesculap Product	
Groups	General Surgical Instruments
Length	385.00 mm
Length (Inch)	15 1/4
Working length (mm)	275.0 mm
Working length (Inch)	10 3/4
Tip length (mm)	9.00 mm
Discipline	Cardiac Surgery, Thoracic Surgery
Surgical Step	Retraction
Type of Sterilization	not sterilized ex works
Data Matrix	No
Disposable / Reusable	reusable
Sterility	non-sterile
Product contains	
Latex	No

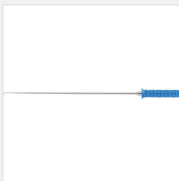

FC351R

VALVE XS Nerve And Vessel Retractor, 385 mm (15 1/4"), working length: 275 mm (10 3/4), fine, tip length: 5 mm, non-sterile, reusable

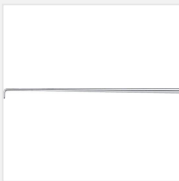

Product search type	Nerve And Vessel Retractor
Brand name	VALVE XS
Aesculap Product	
Groups	General Surgical Instruments
Shape / Form	fine
Length	385.00 mm
Length (Inch)	15 1/4
Working length (mm)	275.0 mm
Working length (Inch)	10 3/4
Tip length (mm)	5.00 mm
Discipline	Cardiac Surgery, Thoracic Surgery
Surgical Step	Retraction
Type of Sterilization	not sterilized ex works
Data Matrix	No
Disposable / Reusable	reusable
Sterility	non-sterile
Product contains	
Latex	No

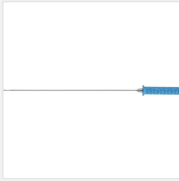
**FC358R****VALVE XS SUTURE CATCHER 390MM**

Product search type	Suture Catcher
Brand name	VALVE XS
Aesculap Product	
Groups	General Surgical Instruments
Length	390.00 mm
Length (Inch)	15 3/8
Working length (mm)	280.0 mm
Working length (Inch)	11
Discipline	Thoracic Surgery, Cardiac Surgery
Data Matrix	No
Product contains	
Latex	No
Sterility	non-sterile
Disposable / Reusable	reusable

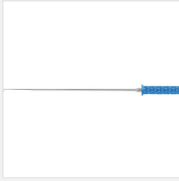
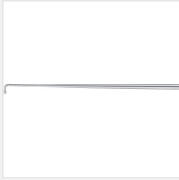
**FC350R****VALVE XS Nerve And Vessel Retractor, 385 mm (15 1/4"), working length: 275 mm (10 3/4), probe-ended, tip length: 4,50 mm, non-sterile, reusable**

Product search type	Nerve And Vessel Retractor
Brand name	VALVE XS
Aesculap Product	
Groups	General Surgical Instruments
Length	385.00 mm
Length (Inch)	15 1/4
Working length (mm)	275.0 mm
Working length (Inch)	10 3/4
Tip profile	bulb-headed tip
Tip length (mm)	4.50 mm
Discipline	Thoracic Surgery, Cardiac Surgery
Surgical Step	Retraction
Type of Sterilization	not sterilized ex works
Data Matrix	No
Disposable / Reusable	reusable
Sterility	non-sterile
Product contains	
Latex	No



FC121R

HEART XS Valve Hook, 250 mm, malleable, jaw length: 65 mm, depth: 18 mm, non-sterile, reusable

Product search type	Valve Hook
Brand name	HEART XS
Aesculap Product	
Groups	General Surgical Instruments
Shape / Form	malleable
Length	250.00 mm
Depth (mm)	18.000 mm
Jaw/Blade Length (mm)	65.00 mm
Jaw/Blade width	18.00 mm
To be used with (code)	FC140R, FC137R, FC120R, FC145R, FC143R
Discipline	Thoracic Surgery, Cardiac Surgery
Surgical Step	Retraction
Type of Sterilization	not sterilized ex works
Data Matrix	Yes
Disposable / Reusable	reusable
Sterility	non-sterile
Product contains Latex	No

Cardiovascular

Retractors



MB047R-MB048R, MB700R-MB703R

ROSS Aortic Valve Retractor

Catalog Number	Blade Size (mm)	Length (in.)
MB047R	15 x 15	10
MB048R	13 x 22	10
MB700R	17 x 24	10
MB701R	13 x 27	10
MB702R	30 x 28	10
MB703R	40 x 25	10

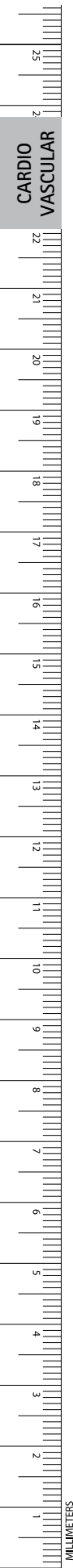
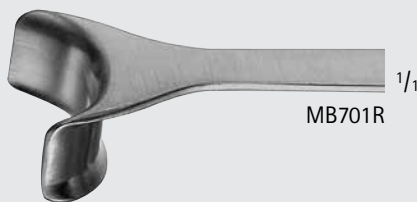

Cardiovascular Retractors

DAVIDSON Scapula Retractor

Catalog Number	Blade Size (mm)	Length (in.)
MB758R	80 x 50	7 3/4
BT531R	90 x 80	7 3/4

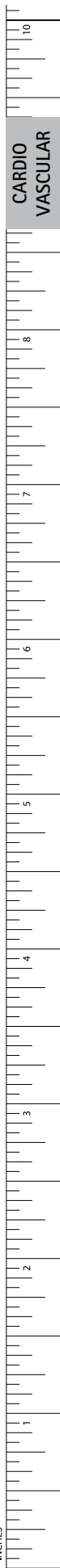
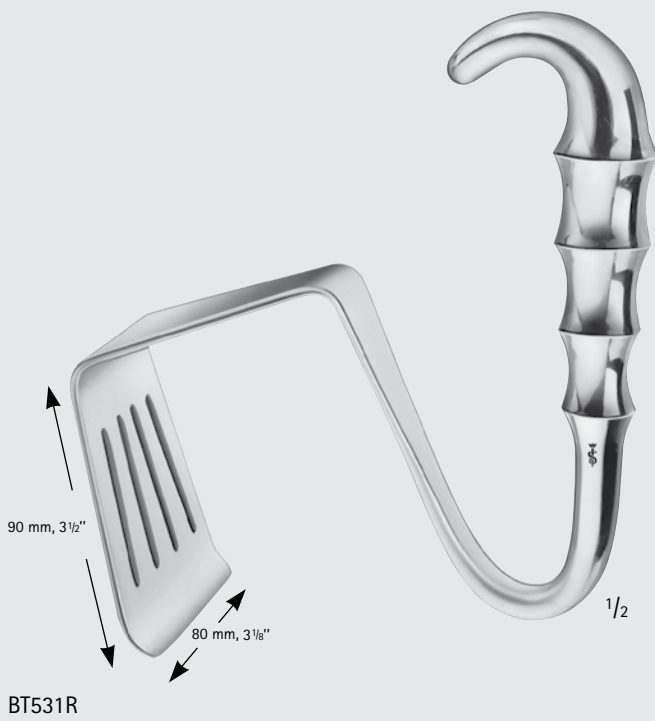
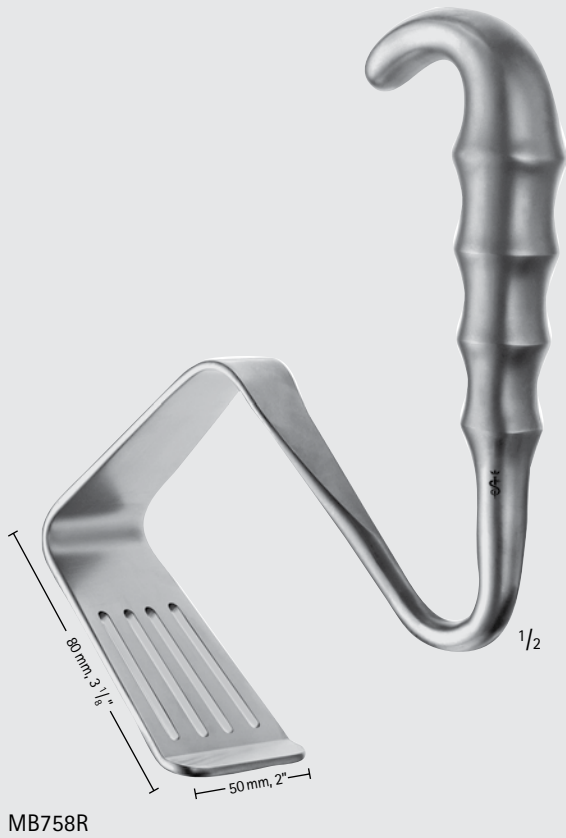



OG007R-OG014R

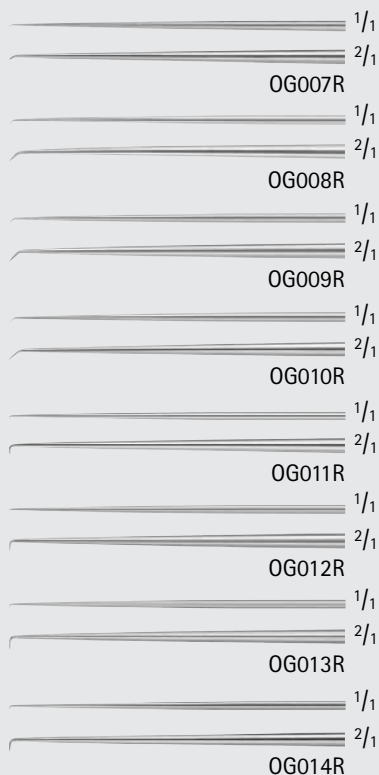

SHAMBAUGH Fen Hook

Catalog Number	Tip Size (mm)	Angle	Length (in.)
OG007R	0.4	45°	6 1/4
OG008R	0.6	45°	6 1/4
OG009R	0.8	45°	6 1/4
OG010R	1.0	45°	6 1/4
OG011R	0.4	90°	6 1/4
OG012R	0.6	90°	6 1/4
OG013R	0.8	90°	6 1/4
OG014R	1.0	90°	6 1/4



OF277R-OF279R

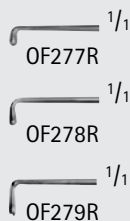

LUCAE Ear Hook Button

Catalog Number	Size	Length (in.)
OF277R	SMALL	5 1/2
OF278R	MEDIUM	5 1/2
OF279R	LARGE	5 1/2

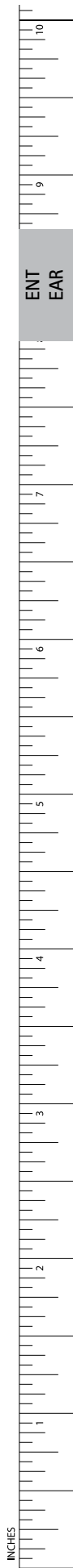



OG015R

Ear Hook, 90 °, angled, 160 mm (6 1/4"), width: 0,200 mm, non-sterile, reusable

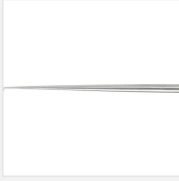

Product search type	Ear Hook
Aesculap Product	
Groups	General Surgical Instruments, ENT
Altern.	
Productname	Micro hook
Geometry	angled
Degree (°)	90.0 °
Length	160.00 mm
Length (Inch)	6 1/4
Width (mm)	0.200 mm
Discipline	Ear-Nose-Throat Surgery
Indication	Ear Microsurgery
Surgical Step	Diss.-Tissue-Others
Type of Sterilization	not sterilized ex works
Data Matrix	No
Disposable /	
Reusable	reusable
Sterility	non-sterile
Product contains	
Latex	No

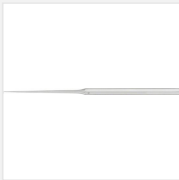

OG081R

Ear Hook, 90 °, angled, 160 mm (6 1/4"), width: 1,500 mm, non-sterile, reusable

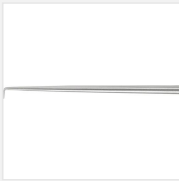

Product search type	Ear Hook
Aesculap Product	
Groups	General Surgical Instruments, ENT
Altern.	
Productname	Micro hook
Geometry	angled
Degree (°)	90.0 °
Length	160.00 mm
Length (Inch)	6 1/4
Width (mm)	1.500 mm
Discipline	Ear-Nose-Throat Surgery
Indication	Ear
Surgical Step	Diss.-Tissue-Others
Type of Sterilization	not sterilized ex works
Data Matrix	No
Disposable /	
Reusable	reusable
Sterility	non-sterile
Product contains	
Latex	No



OG016R

Ear Hook, 90 °, angled, 160 mm (6 1/4"), width: 0,600 mm, non-sterile, reusable

Product search type	Ear Hook
Aesculap Product	
Groups	General Surgical Instruments, ENT
Altern.	
Productname	Micro hook
Geometry	angled
Degree (°)	90.0 °
Length	160.00 mm
Length (Inch)	6 1/4
Width (mm)	0,600 mm
Discipline	Ear-Nose-Throat Surgery
Indication	Ear Microsurgery
Surgical Step	Diss.-Tissue-Others
Type of Sterilization	not sterilized ex works
Data Matrix	No
Disposable /	
Reusable	reusable
Sterility	non-sterile
Product contains	
Latex	No



OG035R

PLESTER Ear Hook, 90 °, angled, 160 mm (6 1/4"), oval tip, width: 0,400 mm, non-sterile, reusable



Product search type	Ear Hook
Author	PLESTER
Aesculap Product	
Groups	General Surgical Instruments, ENT
Altern.	
Productname	Micro hook
Geometry	angled
Degree (°)	90.0 °
Length	160.00 mm
Length (Inch)	6 1/4
Width (mm)	0,400 mm
Tip profile	oval tip
Recommended	
Storage System	JG326, JG325, JG318, JG317, JG316
Discipline	Ear-Nose-Throat Surgery
Indication	Ear Microsurgery
Surgical Step	Diss.-Tissue-Others
Type of Sterilization	not sterilized ex works
Data Matrix	No
Disposable /	
Reusable	reusable
Sterility	non-sterile
Product contains	
Latex	No



OG037R

PLESTER Antrum Hook, 90 °, angled, 160 mm (6 1/4"), cylindrical, blunt, non-sterile, reusable



Product search type	Antrum Hook
Author	PLESTER
Aesculap Product	
Groups	General Surgical Instruments, ENT
Altern.	
Productname	Micro hook
Geometry	angled
Shape / Form	cylindrical
Degree (°)	90.0 °
Length	160.00 mm
Length (Inch)	6 1/4
Tip profile	blunt
Recommended	
Storage System	JG317, JG318, JG316, JG326, JG325
Discipline	Ear-Nose-Throat Surgery
Indication	Ear Microsurgery
Surgical Step	Diss.-Tissue-Others
Type of Sterilization	not sterilized ex works
Data Matrix	No
Disposable /	
Reusable	reusable
Sterility	non-sterile
Product contains	
Latex	No



OG080R

Ear Hook, 90 °, angled, 160 mm (6 1/4"), width: 1,200 mm, non-sterile, reusable

Product search type	Ear Hook
Aesculap Product	
Groups	ENT, General Surgical Instruments
Altern.	
Productname	Micro hook
Geometry	angled
Degree (°)	90.0 °
Length	160.00 mm
Length (Inch)	6 1/4
Width (mm)	1.200 mm
Discipline	Ear-Nose-Throat Surgery
Indication	Ear
Surgical Step	Diss.-Tissue-Others
Type of Sterilization	not sterilized ex works
Data Matrix	No
Disposable /	
Reusable	reusable
Sterility	non-sterile
Product contains	
Latex	No



OG083R

Ear Hook, 90 °, angled, 160 mm (6 1/4"), width: 2,500 mm, non-sterile, reusable

Product search type	Ear Hook
Aesculap Product	
Groups	General Surgical Instruments, ENT
Altern.	
Productname	Micro hook
Geometry	angled
Degree (°)	90.0 °
Length	160.00 mm
Length (Inch)	6 1/4
Width (mm)	2,500 mm
Discipline	Ear-Nose-Throat Surgery
Indication	Ear
Surgical Step	Diss.-Tissue-Others
Type of Sterilization	not sterilized ex works
Data Matrix	No
Disposable /	
Reusable	reusable
Sterility	non-sterile
Product contains	
Latex	No



OG082R

Ear Hook, 90 °, angled, 160 mm (6 1/4"), width: 2 mm, non-sterile, reusable

Product search type	Ear Hook
Aesculap Product	
Groups	ENT, General Surgical Instruments
Altern.	
Productname	Micro hook
Geometry	angled
Degree (°)	90.0 °
Length	160.00 mm
Length (Inch)	6 1/4
Width (mm)	2.000 mm
Discipline	Ear-Nose-Throat Surgery
Indication	Ear
Surgical Step	Diss.-Tissue-Others
Type of Sterilization	not sterilized ex works
Data Matrix	No
Disposable /	
Reusable	reusable
Sterility	non-sterile
Product contains	
Latex	No



OG021R

Ear Hook, retrograde curved, 160 mm (6 1/4"), width: 1 mm, non-sterile, reusable



Product search type	Ear Hook
Aesculap Product	
Groups	ENT, General Surgical Instruments
Altern.	
Productname	Micro hook
Geometry	retrograde curved
Length	160.00 mm
Length (Inch)	6 1/4
Width (mm)	1.000 mm
Recommended	
Storage System	JG316, JG317, JG318, JG325, JG326
Discipline	Ear-Nose-Throat Surgery
Indication	Ear Microsurgery
Surgical Step	Diss.-Tissue-Others
Type of Sterilization	not sterilized ex works
Data Matrix	No
Disposable /	
Reusable	reusable
Sterility	non-sterile
Product contains	
Latex	No



OG034R

HOUGH Ear Hook, 165 mm (6 1/2"), non-sterile, reusable



Product search type	Ear Hook
Author	HOUGH
Aesculap Product	
Groups	ENT, General Surgical Instruments
Altern.	
Productname	Micro hook
Length	165.00 mm
Length (Inch)	6 1/2
Recommended	
Storage System	JG326, JG316, JG317, JG325, JG318
Discipline	Ear-Nose-Throat Surgery
Indication	Ear Microsurgery
Surgical Step	Diss.-Tissue-Others
Type of Sterilization	not sterilized ex works
Data Matrix	No
Disposable /	
Reusable	reusable
Sterility	non-sterile
Product contains	
Latex	No

ENT-NASAL

Retractors



COTTLE Nasal Retractor, Double Ended

Catalog Number	Blade Size (mm)	Tip	Length (in.)
OL214R	12 x 5 / 4 x 4.5	BALL END/ BLUNT	7 7/8



COTTLE Retractor

Catalog Number	Tip	Length (in.)
OL203R	BLUNT/RIGHT SHARP	5 3/4
OL204R	LEFT SHARP/BLUNT	5 3/4

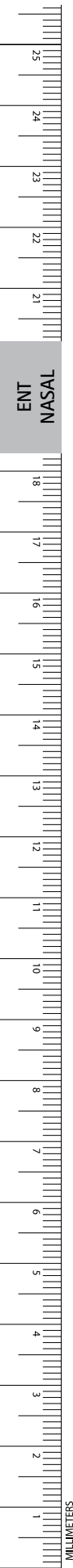

ENT
NASAL

MILLIMETERS

**OP409R**

Micro Hook, 90 °, angled, 250 mm (9 3/4"), blunt, non-sterile, reusable



Product search type **Micro Hook**
Aesculap Product
Groups **General Surgical Instruments, ENT**
Geometry **angled**
Degree (°) **90.0 °**
Length **250.00 mm**
Length (Inch) **9 3/4**
Tip profile **blunt**
Discipline **Ear-Nose-Throat Surgery**
Type of Sterilization **not sterilized ex works**
Data Matrix **No**
Disposable /
Reusable **reusable**
Sterility **non-sterile**
Product contains
Latex **No**

**OP406R**

Micro Hook, retrograde curved, 250 mm (9 3/4"), sharp, non-sterile, reusable



Product search type **Micro Hook**
Aesculap Product
Groups **ENT, General Surgical Instruments**
Geometry **retrograde curved**
Length **250.00 mm**
Length (Inch) **9 3/4**
Tip profile **sharp**
Discipline **Ear-Nose-Throat Surgery**
Type of Sterilization **not sterilized ex works**
Data Matrix **No**
Disposable /
Reusable **reusable**
Sterility **non-sterile**
Product contains
Latex **No**



OP392R

Micro Hook, 180 °, inclined backward, 250 mm (10"), blunt, non-sterile, reusable

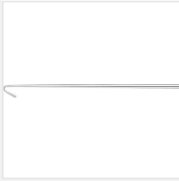

Product search type	Micro Hook
Aesculap Product	
Groups	ENT, General Surgical Instruments
Geometry	inclined backward
Degree (°)	180.0 °
Length	250.00 mm
Length (Inch)	10
Tip profile	blunt
To be used with (code)	OP380R, OP054R
Recommended	
Storage System	JG327
Discipline	Ear-Nose-Throat Surgery
Indication	Laryngology
Surgical Step	Retraction
Type of Sterilization	not sterilized ex works
Data Matrix	No
Disposable /	
Reusable	reusable
Sterility	non-sterile
Product contains	
Latex	No

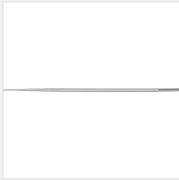

OP390R

Micro Hook, 90 °, angled, 250 mm (10"), blunt, non-sterile, reusable



Product search type	Micro Hook
Aesculap Product	
Groups	ENT, General Surgical Instruments
Geometry	angled
Degree (°)	90.0 °
Length	250.00 mm
Length (Inch)	10
Tip profile	blunt
To be used with (code)	OP380R, OP054R
Recommended	
Storage System	JG327
Discipline	Ear-Nose-Throat Surgery
Indication	Laryngology
Surgical Step	Retraction
Type of Sterilization	not sterilized ex works
Data Matrix	No
Disposable /	
Reusable	reusable
Sterility	non-sterile
Product contains	
Latex	No

Neurosurgery

Skull Opening



FF020R-FF022R

YASARGIL Spring Hook, F/ Galea Fixation W/ Bulldog Clamp

Catalog Number	Tip
FF020R	SMALL
FF022R	LARGE

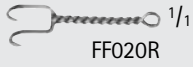

FF020R

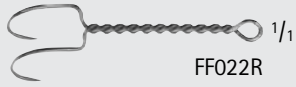

FF022R

NEURO SURGERY

9
8
7
6
5
4
3
2
1
MILLIMETERS



BT220NR

SQ.LINE Bone Hook, 240 mm (9 1/2"), 1 prong, T-handle, non-sterile, reusable

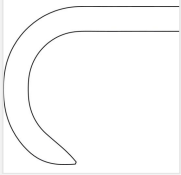

Product search type	Bone Hook
Brand name	SQ.LINE
Aesculap Product	
Groups	General Surgical Instruments
Length	240.00 mm
Length (Inch)	9 1/2
Jaw profile	1 prong
Handle	T-handle
Discipline	Orthopaedics, Traumatology
Indication	Hip
Surgical Step	Dissection-Bone
OP approach	open
Type of Sterilization	not sterilized ex works
Data Matrix	Yes
Disposable /	
Reusable	reusable
Sterility	non-sterile
Product contains	
Latex	No



BT221R

VOLKMANN Wound Retractor (With Prong), 220 mm (8 3/4"), 1 prong, sharp, non-sterile, reusable

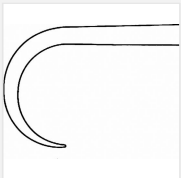

Product search type	Wound Retractor (With Prong)
Author	VOLKMANN
Aesculap Product	
Groups	General Surgical Instruments
Altern.	
Productname	Zinker, bone hook
Length	220.00 mm
Length (Inch)	8 3/4
Jaw profile	1 prong
Tip profile	sharp
Discipline	Thoracic Surgery, Traumatology, Urology, Vascular Surgery, Spine Surgery, Orthopaedics, Neurosurgery, Cardiac Surgery, Gynaecology, General Surgery
Surgical Step	Retraction
Type of Sterilization	not sterilized ex works
Data Matrix	Yes
Disposable /	
Reusable	reusable
Sterility	non-sterile
Product contains	
Latex	No

**BT222R**

VOLKMANN Wound Retractor (With Prong), 225 mm (8 7/8"), 2 prongs, sharp, depth: 9 mm, width: 8 mm, non-sterile, reusable



Product search type	Wound Retractor (With Prong)
Author	VOLKMANN
Aesculap Product	
Groups	General Surgical Instruments
Altern.	
Productname	Zinker
Length	225.00 mm
Length (Inch)	8 7/8
Width (mm)	8.000 mm
Depth (mm)	9.000 mm
Jaw profile	2 prongs
Tip profile	sharp
Discipline	General Surgery, Gynaecology, Cardiac Surgery, Neurosurgery, Orthopaedics, Spine Surgery, Thoracic Surgery, Traumatology, Urology, Vascular Surgery
Surgical Step	Retraction
Type of Sterilization	not sterilized ex works
Data Matrix	Yes
Disposable /	
Reusable	reusable
Sterility	non-sterile
Product contains	
Latex	No

**BT223R**

VOLKMANN Wound Retractor (With Prong), 225 mm (8 7/8"), 3 prongs, sharp, depth: 9 mm, width: 13 mm, non-sterile, reusable



Product search type	Wound Retractor (With Prong)
Author	VOLKMANN
Aesculap Product	
Groups	General Surgical Instruments
Altern.	
Productname	Zinker
Length	225.00 mm
Length (Inch)	8 7/8
Width (mm)	13.000 mm
Depth (mm)	9.000 mm
Jaw profile	3 prongs
Tip profile	sharp
Discipline	General Surgery, Neurosurgery, Cardiac Surgery, Gynaecology, Vascular Surgery, Urology, Orthopaedics, Spine Surgery, Thoracic Surgery, Traumatology
Surgical Step	Retraction
Type of Sterilization	not sterilized ex works
Data Matrix	Yes
Disposable /	
Reusable	reusable
Sterility	non-sterile
Product contains	
Latex	No



BT224R

VOLKMANN Wound Retractor (With Prong), 225 mm (8 7/8"), 4 prongs, sharp, depth: 9 mm, width: 19 mm, non-sterile, reusable



Product search type	Wound Retractor (With Prong)
Author	VOLKMANN
Aesculap Product	
Groups	General Surgical Instruments
Altern.	
Productname	Zinker
Length	225.00 mm
Length (Inch)	8 7/8
Width (mm)	19.000 mm
Depth (mm)	9.000 mm
Jaw profile	4 prongs
Tip profile	sharp
Discipline	Traumatology, Gynaecology, Neurosurgery, Orthopaedics, Spine Surgery, Thoracic Surgery, General Surgery, Vascular Surgery, Cardiac Surgery, Urology
Surgical Step	Retraction
Type of Sterilization	not sterilized ex works
Data Matrix	Yes
Disposable /	
Reusable	reusable
Sterility	non-sterile
Product contains	
Latex	No



BT225R

VOLKMANN Wound Retractor (With Prong), 225 mm (8 7/8"), 6 prongs, sharp, depth: 9 mm, width: 29 mm, non-sterile, reusable

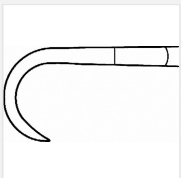

Product search type	Wound Retractor (With Prong)
Author	VOLKMANN
Aesculap Product	
Groups	General Surgical Instruments
Altern.	
Productname	Zinker
Length	225.00 mm
Length (Inch)	8 7/8
Width (mm)	29.000 mm
Depth (mm)	9.000 mm
Jaw profile	6 prongs
Tip profile	sharp
Discipline	Neurosurgery, Cardiac Surgery, Spine Surgery, Orthopaedics, Gynaecology, General Surgery, Vascular Surgery, Urology, Traumatology, Thoracic Surgery
Surgical Step	Retraction
Type of Sterilization	not sterilized ex works
Data Matrix	Yes
Disposable /	
Reusable	reusable
Sterility	non-sterile
Product contains	
Latex	No

**BT227R**

VOLKMANN Wound Retractor (With Prong), 225 mm (8 7/8"), 2 prongs, blunt, depth: 8,500 mm, width: 8 mm, non-sterile, reusable



Product search type	Wound Retractor (With Prong)
Author	VOLKMANN
Aesculap Product	
Groups	General Surgical Instruments
Altern.	
Productname	Zinker
Length	225.00 mm
Length (Inch)	8 7/8
Width (mm)	8.000 mm
Depth (mm)	8.500 mm
Jaw profile	2 prongs
Tip profile	blunt
Discipline	General Surgery, Gynaecology, Vascular Surgery, Urology, Traumatology, Thoracic Surgery, Spine Surgery, Cardiac Surgery, Orthopaedics, Neurosurgery
Surgical Step	Retraction
Type of Sterilization	not sterilized ex works
Data Matrix	Yes
Disposable /	
Reusable	reusable
Sterility	non-sterile
Product contains	
Latex	No

**BT228R**

VOLKMANN Wound Retractor (With Prong), 225 mm (8 7/8"), 3 prongs, blunt, depth: 8,500 mm, width: 13 mm, non-sterile, reusable



Product search type	Wound Retractor (With Prong)
Author	VOLKMANN
Aesculap Product	
Groups	General Surgical Instruments
Altern.	
Productname	Zinker
Length	225.00 mm
Length (Inch)	8 7/8
Width (mm)	13.000 mm
Depth (mm)	8.500 mm
Jaw profile	3 prongs
Tip profile	blunt
Discipline	Urology, Traumatology, Gynaecology, Vascular Surgery, General Surgery, Thoracic Surgery, Cardiac Surgery, Spine Surgery, Neurosurgery, Orthopaedics
Surgical Step	Retraction
Type of Sterilization	not sterilized ex works
Data Matrix	Yes
Disposable /	
Reusable	reusable
Sterility	non-sterile
Product contains	
Latex	No



BT229R

VOLKMANN Wound Retractor (With Prong), 225 mm (8 7/8"), 4 prongs, blunt, depth: 8,500 mm, width: 19 mm, non-sterile, reusable



Product search type	Wound Retractor (With Prong)
Author	VOLKMANN
Aesculap Product	
Groups	General Surgical Instruments
Altern.	
Productname	Zinker
Length	225.00 mm
Length (Inch)	8 7/8
Width (mm)	19.000 mm
Depth (mm)	8.500 mm
Jaw profile	4 prongs
Tip profile	blunt
Discipline	Spine Surgery, General Surgery, Thoracic Surgery, Traumatology, Urology, Vascular Surgery, Gynaecology, Orthopaedics, Neurosurgery, Cardiac Surgery
Surgical Step	Retraction
Type of Sterilization	not sterilized ex works
Data Matrix	Yes
Disposable /	
Reusable	reusable
Sterility	non-sterile
Product contains	
Latex	No



BT230R

VOLKMANN Wound Retractor (With Prong), 225 mm (8 7/8"), 6 prongs, blunt, depth: 8,500 mm, width: 29 mm, non-sterile, reusable



Product search type	Wound Retractor (With Prong)
Author	VOLKMANN
Aesculap Product	
Groups	General Surgical Instruments
Altern.	
Productname	Zinker
Length	225.00 mm
Length (Inch)	8 7/8
Width (mm)	29.000 mm
Depth (mm)	8.500 mm
Jaw profile	6 prongs
Tip profile	blunt
Discipline	General Surgery, Gynaecology, Vascular Surgery, Cardiac Surgery, Urology, Traumatology, Thoracic Surgery, Neurosurgery, Spine Surgery, Orthopaedics
Surgical Step	Retraction
Type of Sterilization	not sterilized ex works
Data Matrix	Yes
Disposable /	
Reusable	reusable
Sterility	non-sterile
Product contains	
Latex	No

**BT232R**

Wound Retractor (With Prong), 245 mm (9 5/8"), 1 prong, sharp, non-sterile, reusable

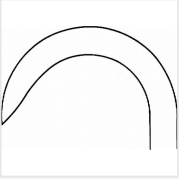

Product search type Wound Retractor (With Prong)
Aesculap Product
Groups General Surgical Instruments
Altern.
Productname bone hook, Zinker
Length 245.00 mm
Length (Inch) 9 5/8
Jaw profile 1 prong
Tip profile sharp
Discipline Traumatology, Orthopaedics
Surgical Step Retraction
Type of Sterilization not sterilized ex works
Data Matrix Yes
Disposable /
Reusable reusable
Sterility non-sterile
Product contains
Latex No

**BT234R**

KOCHER Wound Retractor (With Prong), 205 mm (8"), 1 prong, sharp, non-sterile, reusable

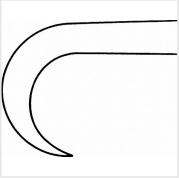

Product search type Wound Retractor (With Prong)
Author KOCHER
Aesculap Product
Groups General Surgical Instruments
Altern.
Productname bone hook, Zinker
Length 205.00 mm
Length (Inch) 8
Jaw profile 1 prong
Tip profile sharp
Discipline Traumatology, Orthopaedics, Hand / Foot Surgery
Surgical Step Retraction
Type of Sterilization not sterilized ex works
Data Matrix Yes
Disposable /
Reusable reusable
Sterility non-sterile
Product contains
Latex No

**BT238R**

KOCHER Wound Retractor (With Prong), 220 mm (8 3/4"), 1 prong, sharp, non-sterile, reusable

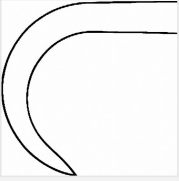

Product search type	Wound Retractor (With Prong)
Author	KOCHER
Aesculap Product	
Groups	General Surgical Instruments
Altern.	
Productname	bone hook, Zinker
Length	220.00 mm
Length (Inch)	8 3/4
Jaw profile	1 prong
Tip profile	sharp
Discipline	Traumatology, Orthopaedics, Hand / Foot Surgery
Surgical Step	Retraction
Type of Sterilization	not sterilized ex works
Data Matrix	Yes
Disposable /	
Reusable	reusable
Sterility	non-sterile
Product contains	
Latex	No

**BT239R**

KOCHER Wound Retractor (With Prong), 220 mm (8 3/4"), 1 prong, blunt, non-sterile, reusable

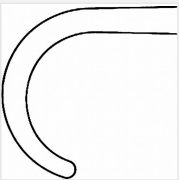

Product search type	Wound Retractor (With Prong)
Author	KOCHER
Aesculap Product	
Groups	General Surgical Instruments
Altern.	
Productname	bone hook, Zinker
Length	220.00 mm
Length (Inch)	8 3/4
Jaw profile	1 prong
Tip profile	blunt
Discipline	Traumatology, Orthopaedics
Surgical Step	Retraction
Type of Sterilization	not sterilized ex works
Data Matrix	Yes
Disposable /	
Reusable	reusable
Sterility	non-sterile
Product contains	
Latex	No

**BT240R**

VOLKMANN Wound Retractor (With Prong), 220 mm (8 3/4"), 1 prong, sharp, non-sterile, reusable

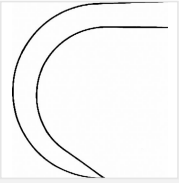

Product search type	Wound Retractor (With Prong)
Author	VOLKMANN
Aesculap Product	
Groups	General Surgical Instruments
Altern.	
Productname	Zinker, bone hook
Length	220.00 mm
Length (Inch)	8 3/4
Jaw profile	1 prong
Tip profile	sharp
Discipline	Orthopaedics, Traumatology
Surgical Step	Retraction
Type of Sterilization	not sterilized ex works
Data Matrix	Yes
Disposable /	
Reusable	reusable
Sterility	non-sterile
Product contains	
Latex	No

**BT241R**

VOLKMANN Wound Retractor (With Prong), 220 mm (8 3/4"), 1 prong, blunt, non-sterile, reusable

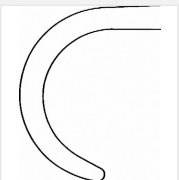

Product search type	Wound Retractor (With Prong)
Author	VOLKMANN
Aesculap Product	
Groups	General Surgical Instruments
Altern.	
Productname	bone hook, Zinker
Length	220.00 mm
Length (Inch)	8 3/4
Jaw profile	1 prong
Tip profile	blunt
Discipline	Traumatology, Orthopaedics
Surgical Step	Retraction
Type of Sterilization	not sterilized ex works
Data Matrix	Yes
Disposable /	
Reusable	reusable
Sterility	non-sterile
Product contains	
Latex	No



BT126R

Wound- And Trachea Retractor, large curve, 165 mm (6 1/2"), 1 prong, blunt, non-sterile, reusable

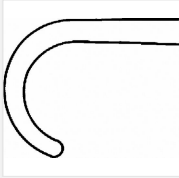
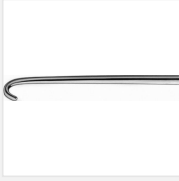

Product search type Wound- And Trachea Retractor

Aesculap Product

Groups General Surgical Instruments

Geometry large curve

Length 165.00 mm

Length (Inch) 6 1/2

Jaw profile 1 prong

Tip profile blunt

Discipline Plastic Surgery, General Surgery, Gynaecology, Hand / Foot Surgery, Cardiac Surgery, Maxillo-Facial Surgery, Traumatology, Orthopaedics, Pediatric Surgery, Thoracic Surgery, Urology, Ear-Nose-Throat Surgery, Vascular Surgery

Surgical Step Retraction

Type of Sterilization not sterilized ex works

Data Matrix Yes

Disposable /

Reusable reusable

Sterility non-sterile

Product contains

Latex No



BT129R

Wound- And Trachea Retractor, large curve, 165 mm (6 1/2"), 4 prongs, blunt, depth: 6,800 mm, width: 14 mm, non-sterile, reusable



Product search type Wound- And Trachea Retractor

Aesculap Product

Groups General Surgical Instruments

Geometry large curve

Length 165.00 mm

Length (Inch) 6 1/2

Width (mm) 14.000 mm

Depth (mm) 6.800 mm

Jaw profile 4 prongs

Tip profile blunt

Discipline Traumatology, Plastic Surgery, Pediatric Surgery, Orthopaedics, Maxillo-Facial Surgery, Hand / Foot Surgery, Gynaecology, General Surgery, Ear-Nose-Throat Surgery

Surgical Step Retraction

Type of Sterilization not sterilized ex works

Data Matrix Yes

Disposable /

Reusable reusable

Sterility non-sterile

Product contains

Latex No



BT120R

Retractor, 175 mm (6 7/8"), 1 prong, blunt, depth: 3,800 mm, non-sterile, reusable



Product search type **Retractor**
Aesculap Product
Groups **General Surgical Instruments**
Length **175.00 mm**
Length (Inch) **6 7/8**
Depth (mm) **3.800 mm**
Jaw profile **1 prong**
Tip profile **blunt**
Discipline **Plastic Surgery, Traumatology, Pediatric Surgery, Orthopaedics, Maxillo-Facial Surgery, Hand / Foot Surgery, Gynaecology, General Surgery, Ear-Nose-Throat Surgery**
Type of Sterilization **not sterilized ex works**
Data Matrix **Yes**
Disposable /
Reusable **reusable**
Sterility **non-sterile**
Product contains
Latex **No**



BT121R

Wound- And Trachea Retractor, large curve, 165 mm (6 1/2"), 1 prong, sharp, non-sterile, reusable

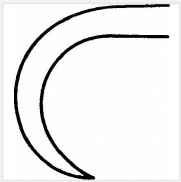

Product search type **Wound- And Trachea Retractor**
Aesculap Product
Groups **General Surgical Instruments**
Geometry **large curve**
Length **165.00 mm**
Length (Inch) **6 1/2**
Jaw profile **1 prong**
Tip profile **sharp**
Discipline **Ear-Nose-Throat Surgery, General Surgery, Gynaecology, Hand / Foot Surgery, Maxillo-Facial Surgery, Orthopaedics, Pediatric Surgery, Plastic Surgery, Traumatology, Urology**
Surgical Step **Retraction**
Type of Sterilization **not sterilized ex works**
Data Matrix **Yes**
Disposable /
Reusable **reusable**
Sterility **non-sterile**
Product contains
Latex **No**



BT123R

Wound- And Trachea Retractor, large curve, 165 mm (6 1/2"), 3 prongs, sharp, depth: 7,500 mm, width: 10 mm, non-sterile, reusable



Product search type	Wound- And Trachea Retractor
Aesculap Product	
Groups	General Surgical Instruments
Geometry	large curve
Length	165.00 mm
Length (Inch)	6 1/2
Width (mm)	10.000 mm
Depth (mm)	7.500 mm
Jaw profile	3 prongs
Tip profile	sharp
Discipline	Gynaecology, Pediatric Surgery, Plastic Surgery, Traumatology, Urology, Orthopaedics, Ear-Nose-Throat Surgery, General Surgery, Hand / Foot Surgery, Maxillo-Facial Surgery
Surgical Step	Retraction
Type of Sterilization	not sterilized ex works
Data Matrix	Yes
Disposable /	
Reusable	reusable
Sterility	non-sterile
Product contains	
Latex	No



BT128R

Wound- And Trachea Retractor, large curve, 165 mm (6 1/2"), 3 prongs, blunt, depth: 6,800 mm, width: 10 mm, non-sterile, reusable



Product search type	Wound- And Trachea Retractor
Aesculap Product	
Groups	General Surgical Instruments
Geometry	large curve
Length	165.00 mm
Length (Inch)	6 1/2
Width (mm)	10.000 mm
Depth (mm)	6.800 mm
Jaw profile	3 prongs
Tip profile	blunt
Discipline	Gynaecology, Traumatology, Plastic Surgery, Pediatric Surgery, General Surgery, Ear-Nose-Throat Surgery, Hand / Foot Surgery, Maxillo-Facial Surgery, Orthopaedics
Surgical Step	Retraction
Type of Sterilization	not sterilized ex works
Data Matrix	Yes
Disposable /	
Reusable	reusable
Sterility	non-sterile
Product contains	
Latex	No



BT122R

Wound- And Trachea Retractor, large curve, 165 mm (6 1/2"), 2 prongs, sharp, depth: 7,500 mm, width: 7,500 mm, non-sterile, reusable



Product search type	Wound- And Trachea Retractor
Aesculap Product	
Groups	General Surgical Instruments
Geometry	large curve
Length	165.00 mm
Length (Inch)	6 1/2
Width (mm)	7.500 mm
Depth (mm)	7.500 mm
Jaw profile	2 prongs
Tip profile	sharp
Discipline	Ear-Nose-Throat Surgery, General Surgery, Plastic Surgery, Traumatology, Gynaecology, Urology, Hand / Foot Surgery, Maxillo-Facial Surgery, Orthopaedics, Pediatric Surgery
Surgical Step	Retraction
Type of Sterilization	not sterilized ex works
Data Matrix	Yes
Disposable /	
Reusable	reusable
Sterility	non-sterile
Product contains	
Latex	No



BT124R

Wound- And Trachea Retractor, large curve, 165 mm (6 1/2"), 4 prongs, sharp, depth: 7,500 mm, width: 14 mm, non-sterile, reusable



Product search type	Wound- And Trachea Retractor
Aesculap Product	
Groups	General Surgical Instruments
Geometry	large curve
Length	165.00 mm
Length (Inch)	6 1/2
Width (mm)	14.000 mm
Depth (mm)	7.500 mm
Jaw profile	4 prongs
Tip profile	sharp
Discipline	Urology, Traumatology, Plastic Surgery, Pediatric Surgery, Orthopaedics, Maxillo-Facial Surgery, Hand / Foot Surgery, Gynaecology, General Surgery, Ear-Nose-Throat Surgery
Surgical Step	Retraction
Type of Sterilization	not sterilized ex works
Data Matrix	Yes
Disposable /	
Reusable	reusable
Sterility	non-sterile
Product contains	
Latex	No



BT127R

Wound- And Trachea Retractor, large curve, 165 mm (6 1/2"), 2 prongs, blunt, depth: 6,800 mm, width: 7,500 mm, non-sterile, reusable



Product search type	Wound- And Trachea Retractor
Aesculap Product	
Groups	General Surgical Instruments
Geometry	large curve
Length	165.00 mm
Length (Inch)	6 1/2
Width (mm)	7.500 mm
Depth (mm)	6.800 mm
Jaw profile	2 prongs
Tip profile	blunt
Discipline	Pediatric Surgery, Orthopaedics, Plastic Surgery, Traumatology, Maxillo-Facial Surgery, Hand / Foot Surgery, Gynaecology, Ear-Nose-Throat Surgery, General Surgery
Surgical Step	Retraction
Type of Sterilization	not sterilized ex works
Data Matrix	Yes
Disposable /	
Reusable	reusable
Sterility	non-sterile
Product contains	
Latex	No



MB736R

JACKSON Skin Hook, 136 mm (5 1/4"), non-sterile, reusable



Product search type	Skin Hook
Author	JACKSON
Aesculap Product	
Groups	General Surgical Instruments
Length	136.00 mm
Length (Inch)	5 1/4
Discipline	Ear-Nose-Throat Surgery, General Surgery, Plastic Surgery
Surgical Step	Diss.-Tissue-Others
Type of Sterilization	not sterilized ex works
Data Matrix	Yes
Disposable /	
Reusable	reusable
Sterility	non-sterile
Product contains	
Latex	No

Urology

Retractors



BT210R-BT217R

1/2

GIL VERNET Vein Retractor

Catalog Number	Blade Size (mm)	Length (in.)
BT210R	10 x 4	9 1/2
BT211R	10 x 6	9 1/2
BT212R	10 x 8	9 1/2
BT213R	10 x 11	9 1/2
BT214R	13 x 15	9 1/2
BT215R	13 x 17	9 1/2
BT216R	14 x 20	9 1/2
BT217R	16 x 23	9 1/2



BT210R



BT211R



BT212R



BT213R



BT214R



BT215R



BT216R



BT217R

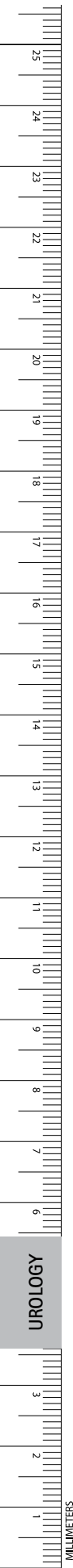

UROLOGY

MILLIMETERS



OL210R

Wound Retractor (Double Ended), 195 mm (7 3/4"), depth: 10 mm, width: 12 mm, 3 mm, non-sterile, reusable



Product search type	Wound Retractor (Double Ended)
Aesculap Product	
Groups	General Surgical Instruments
Length	195.00 mm
Length (Inch)	7 3/4
Width (mm)	12.000 mm
Depth (mm)	10.000 mm
Dimenions	3 mm
Discipline	Ear-Nose-Throat Surgery, Plastic Surgery, Maxillo-Facial Surgery
Type of Sterilization	not sterilized ex works
Data Matrix	No
Disposable /	
Reusable	reusable
Sterility	non-sterile
Product contains	
Latex	No



OL211R

MASING Wound Retractor, 140 mm (5 1/2"), depth: 6 mm, width: 12 mm, non-sterile, reusable



Product search type	Wound Retractor
Author	MASING
Aesculap Product	
Groups	General Surgical Instruments, ENT
Length	140.00 mm
Length (Inch)	5 1/2
Width (mm)	12.000 mm
Depth (mm)	6.000 mm
Discipline	Ear-Nose-Throat Surgery, Maxillo-Facial Surgery, Plastic Surgery
Surgical Step	Retraction
Type of Sterilization	not sterilized ex works
Data Matrix	Yes
Disposable /	
Reusable	reusable
Sterility	non-sterile
Product contains	
Latex	No



OL212R

COTTLE Wound Retractor, 140 mm (5 1/2"), depth: 10 mm, width: 12 mm, non-sterile, reusable



Product search type	Wound Retractor
Author	COTTLE
Aesculap Product	
Groups	General Surgical Instruments, ENT
Length	140.00 mm
Length (Inch)	5 1/2
Width (mm)	12.000 mm
Depth (mm)	10.000 mm
Discipline	Plastic Surgery, Ear-Nose-Throat Surgery, Maxillo-Facial Surgery
Surgical Step	Retraction
Type of Sterilization	not sterilized ex works
Data Matrix	Yes
Disposable /	
Reusable	reusable
Sterility	non-sterile
Product contains	
Latex	No



OL214R

COTTLE Wound Retractor, 200 mm (7 7/8"), double ended, blunt, non-sterile, reusable



Product search type	Wound Retractor
Author	COTTLE
Aesculap Product	
Groups	General Surgical Instruments, ENT
Shape / Form	double ended
Length	200.00 mm
Length (Inch)	7 7/8
Tip profile	blunt
Recommended	
Storage System	JG326, JG325
Discipline	Plastic Surgery, Maxillo-Facial Surgery, Ear-Nose-Throat Surgery
Indication	Rhinoplasty
Surgical Step	Retraction
Type of Sterilization	not sterilized ex works
Data Matrix	Yes
Disposable /	
Reusable	reusable
Sterility	non-sterile
Product contains	
Latex	No

По вопросам продаж и поддержки обращайтесь:

Алматы (7273)495-231	Казань (843)206-01-48	Новокузнецк (3843)20-46-81	Смоленск (4812)29-41-54
Архангельск (8182)63-90-72	Калининград (4012)72-03-81	Новосибирск (383)227-86-73	Сочи (862)225-72-31
Астрахань (8512)99-46-04	Калуга (4842)92-23-67	Омск (3812)21-46-40	Ставрополь (8652)20-65-13
Барнаул (3852)73-04-60	Кемерово (3842)65-04-62	Орел (4862)44-53-42	Сургут (3462)77-98-35
Белгород (4722)40-23-64	Киров (8332)68-02-04	Оренбург (3532)37-68-04	Тверь (4822)63-31-35
Брянск (4832)59-03-52	Краснодар (861)203-40-90	Пенза (8412)22-31-16	Томск (3822)98-41-53
Владивосток (423)249-28-31	Красноярск (391)204-63-61	Пермь (342)205-81-47	Тула (4872)74-02-29
Волгоград (844)278-03-48	Курск (4712)77-13-04	Ростов-на-Дону (863)308-18-15	Тюмень (3452)66-21-18
Вологда (8172)26-41-59	Липецк (4742)52-20-81	Рязань (4912)46-61-64	Ульяновск (8422)24-23-59
Воронеж (473)204-51-73	Магнитогорск (3519)55-03-13	Самара (846)206-03-16	Уфа (347)229-48-12
Екатеринбург (343)384-55-89	Москва (495)268-04-70	Санкт-Петербург (812)309-46-40	Хабаровск (4212)92-98-04
Иваново (4932)77-34-06	Мурманск (8152)59-64-93	Саратов (845)249-38-78	Челябинск (351)202-03-61
Ижевск (3412)26-03-58	Набережные Челны (8552)20-53-41	Севастополь (8692)22-31-93	Череповец (8202)49-02-64
Иркутск (395)279-98-46	Нижний Новгород (831)429-08-12	Симферополь (3652)67-13-56	Ярославль (4852)69-52-93
Россия (495)268-04-70	Киргизия (996)312-96-26-47	Казахстан (7172)727-132	