

Технические характеристики

По вопросам продаж и поддержки обращайтесь:

Алматы (7273)495-231	Казань (843)206-01-48	Новокузнецк (3843)20-46-81	Смоленск (4812)29-41-54
Архангельск (8182)63-90-72	Калининград (4012)72-03-81	Новосибирск (383)227-86-73	Сочи (862)225-72-31
Астрахань (8512)99-46-04	Калуга (4842)92-23-67	Омск (3812)21-46-40	Ставрополь (8652)20-65-13
Барнаул (3852)73-04-60	Кемерово (3842)65-04-62	Орел (4862)44-53-42	Сургут (3462)77-98-35
Белгород (4722)40-23-64	Киров (8332)68-02-04	Оренбург (3532)37-68-04	Тверь (4822)63-31-35
Брянск (4832)59-03-52	Краснодар (861)203-40-90	Пенза (8412)22-31-16	Томск (3822)98-41-53
Владивосток (423)249-28-31	Красноярск (391)204-63-61	Пермь (342)205-81-47	Тула (4872)74-02-29
Волгоград (844)278-03-48	Курск (4712)77-13-04	Ростов-на-Дону (863)308-18-15	Тюмень (3452)66-21-18
Вологда (8172)26-41-59	Липецк (4742)52-20-81	Рязань (4912)46-61-64	Ульяновск (8422)24-23-59
Воронеж (473)204-51-73	Магнитогорск (3519)55-03-13	Самара (846)206-03-16	Уфа (347)229-48-12
Екатеринбург (343)384-55-89	Москва (495)268-04-70	Санкт-Петербург (812)309-46-40	Хабаровск (4212)92-98-04
Иваново (4932)77-34-06	Мурманск (8152)59-64-93	Саратов (845)249-38-78	Челябинск (351)202-03-61
Ижевск (3412)26-03-58	Набережные Челны (8552)20-53-41	Севастополь (8692)22-31-93	Череповец (8202)49-02-64
Иркутск (395)279-98-46	Нижний Новгород (831)429-08-12	Симферополь (3652)67-13-56	Ярославль (4852)69-52-93
Россия (495)268-04-70	Киргизия (996)312-96-26-47	Казахстан (7172)727-132	



Arterienklemmen – Hemostatic Forceps

Arterienklemmen
Hemostatic Forceps

BH

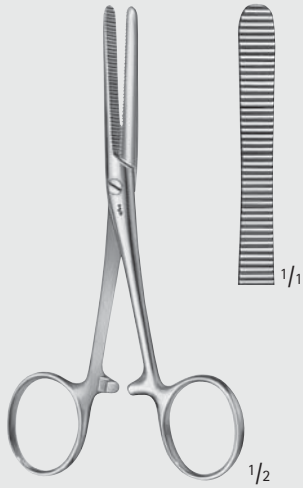
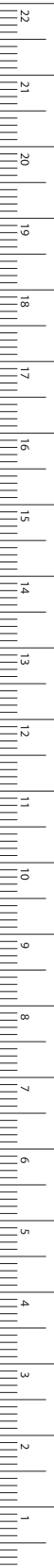

PEAN

BH410R

125 mm, 5"



KRÖNLEIN

BH300R

130 mm, 5 1/8"



PEAN

BH302R-BH304R

BH302R	BH304R
125 mm	140 mm
5"	5 1/2"

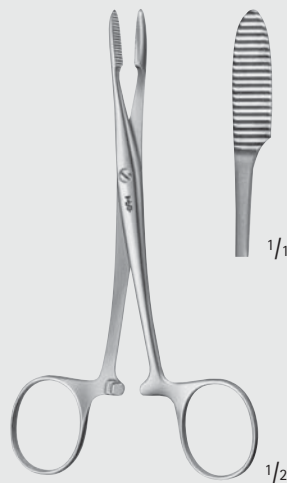

PEAN

BH312R

125 mm, 5"

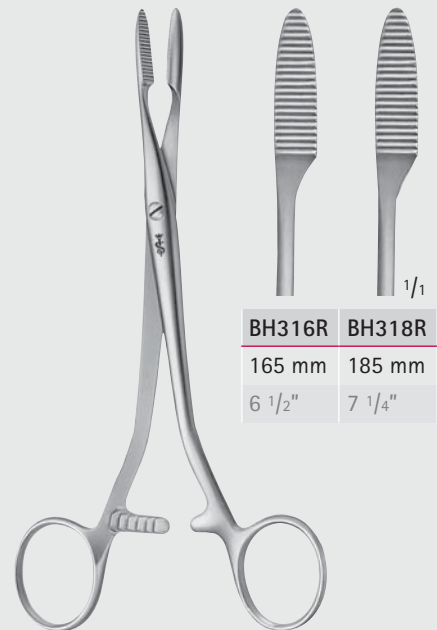

PEAN

BH316R-BH318R

BH316R	BH318R
165 mm	185 mm
6 1/2"	7 1/4"

MILLIMETERS

Arterienklemmen – Hemostatic Forceps

Arterienklemmen

Hemostatic Forceps

BH

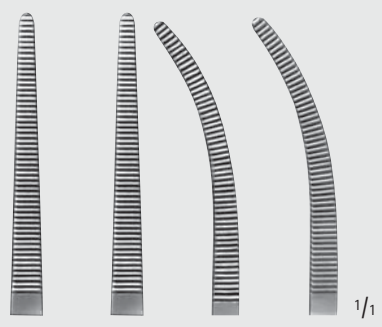

BH412R	BH414R	BH413R	BH415R
130 mm	140 mm	130 mm	140 mm
5 1/8"	5 1/2"	5 1/8"	5 1/2"

PEAN

BH412R-BH415R

grazile Form
slender type

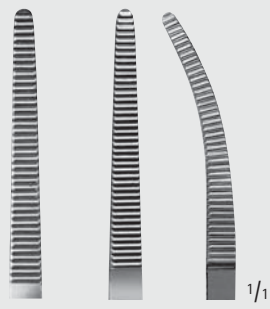

BH422R	BH424R	BH425R
130 mm	140 mm	140 mm
5 1/8"	5 1/2"	5 1/2"

PEAN

BH422R-BH425R

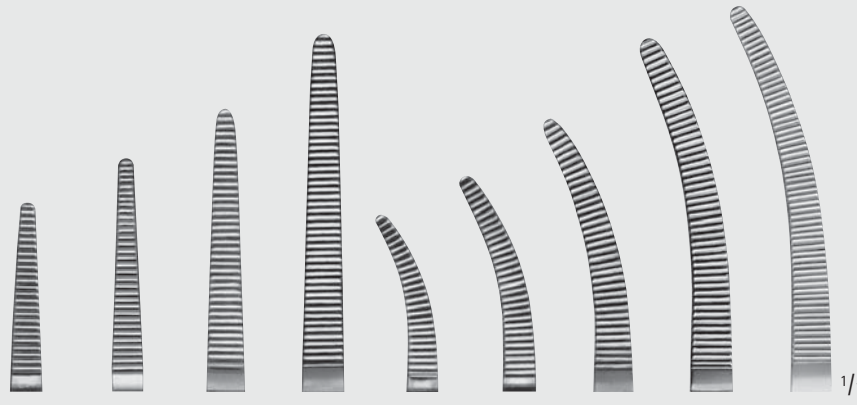

BH332R	BH334R	BH336R	BH338R	BH333R	BH335R	BH337R	BH339R	BH361R
130 mm	150 mm	175 mm	200 mm	130 mm	150 mm	175 mm	200 mm	230 mm
5 1/8"	6"	7"	8"	5 1/8"	6"	7"	8"	9"

SPENCER-WELLS

BH332R-BH361R



Arterienklemmen – Hemostatic Forceps

Arterienklemmen

Hemostatic Forceps

BH

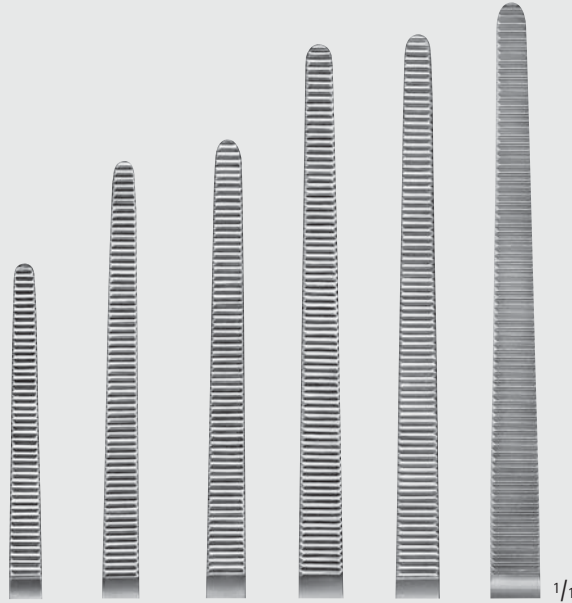

BH442R	BH444R	BH446R	BH448R	BH450R	BH456R
160 mm	185 mm	200 mm	225 mm	240 mm	350 mm
6 1/4"	7 1/4"	8"	9"	9 1/2"	14"

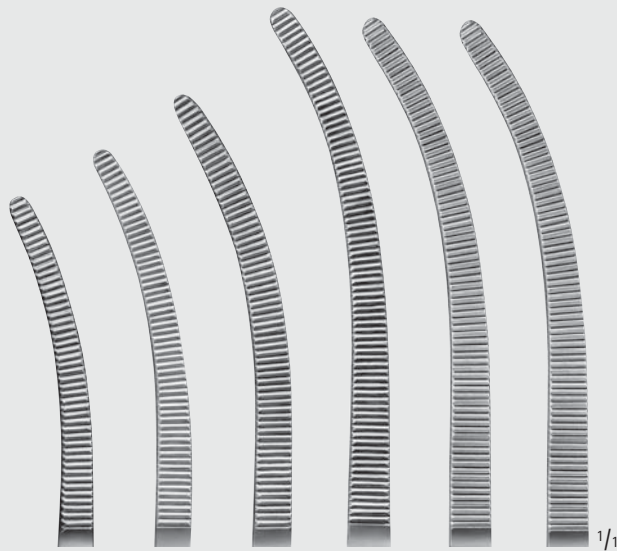

BH443R	BH445R	BH447R	BH449R	BH451R	BH457R
160 mm	185 mm	200 mm	225 mm	240 mm	350 mm
6 1/4"	7 1/4"	8"	9"	9 1/2"	14"



ROCHESTER-PEAN

BH442R-BH457R

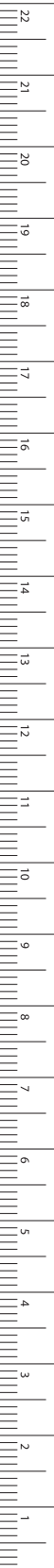

MILLIMETERS

Arterienklemmen – Hemostatic Forceps

Arterienklemmen

Hemostatic Forceps

BH



PEAN

BH470R-BH475R

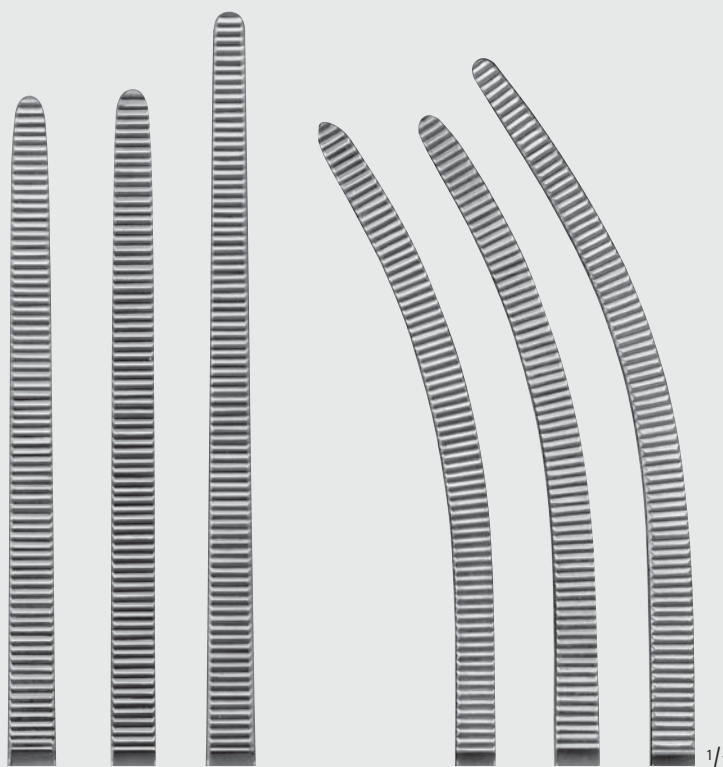

BH470R	BH472R	BH474R
240 mm	260 mm	280 mm
9 1/2"	10 1/4"	11"

BH471R	BH473R	BH475R
240 mm	260 mm	280 mm
9 1/2"	10 1/4"	11"

1/1



Arterienklemmen – Hemostatic Forceps

Arterienklemmen

Hemostatic Forceps

BH



KOCHER

BH610R

kräftiges Modell
strong pattern
145 mm, 5 3/4"

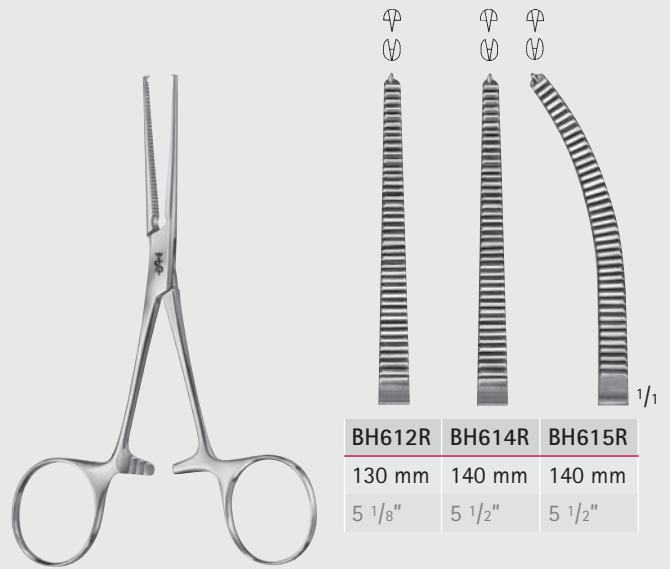

KOCHER

BH612R–BH615R

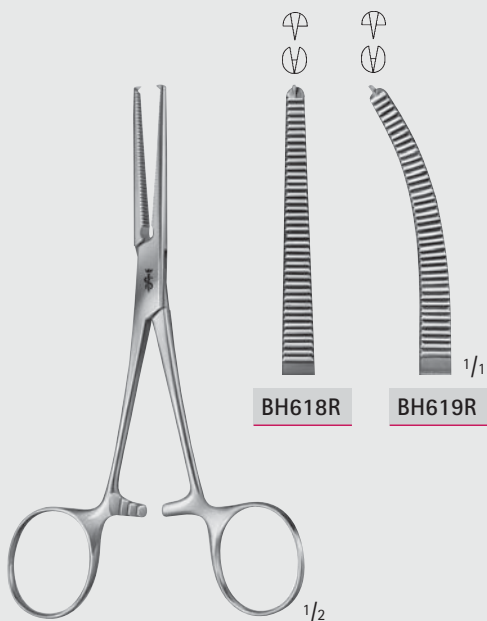

ROCHESTER-OCHSNER

BH618R–BH619R

140 mm, 5 1/2"



KOCHER

BH630R–BH631R

150 mm, 6"

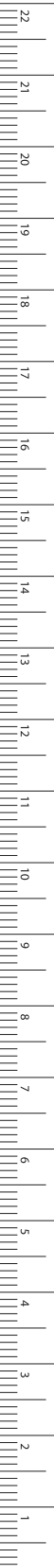

MILLIMETERS

Arterienklemmen – Hemostatic Forceps

Arterienklemmen

Hemostatic Forceps

BH

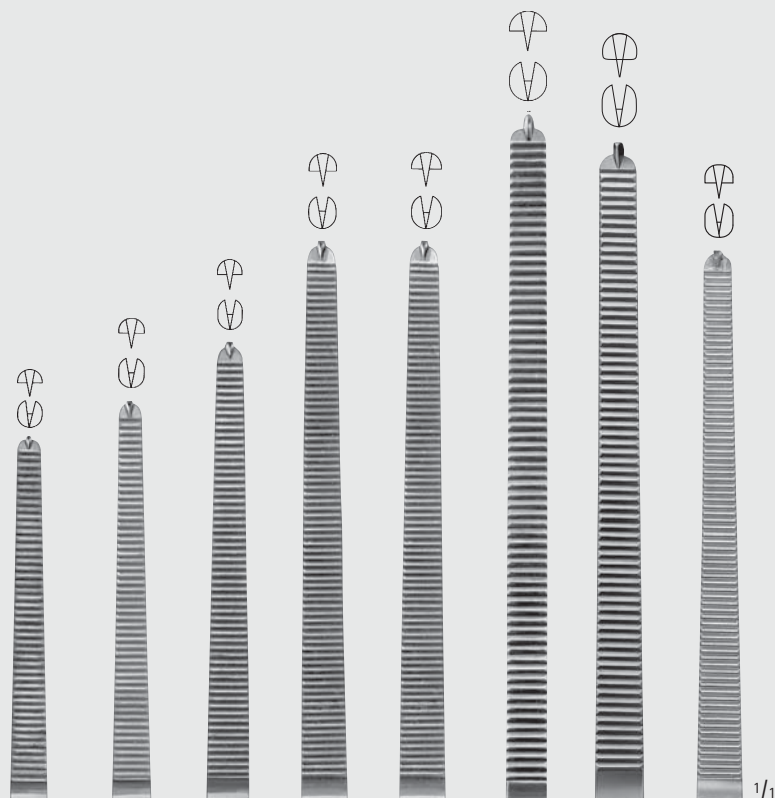

BH642R	BH644R	BH646R	BH648R	BH650R	BH652R	BH654R	BH658R
160 mm	185 mm	200 mm	225 mm	240 mm	260 mm	280 mm	350 mm
6 1/4"	7 1/4"	8"	9"	9 1/2"	10 1/4"	11"	14"



KOCHER-OCHSNER

BH642R-BH659R

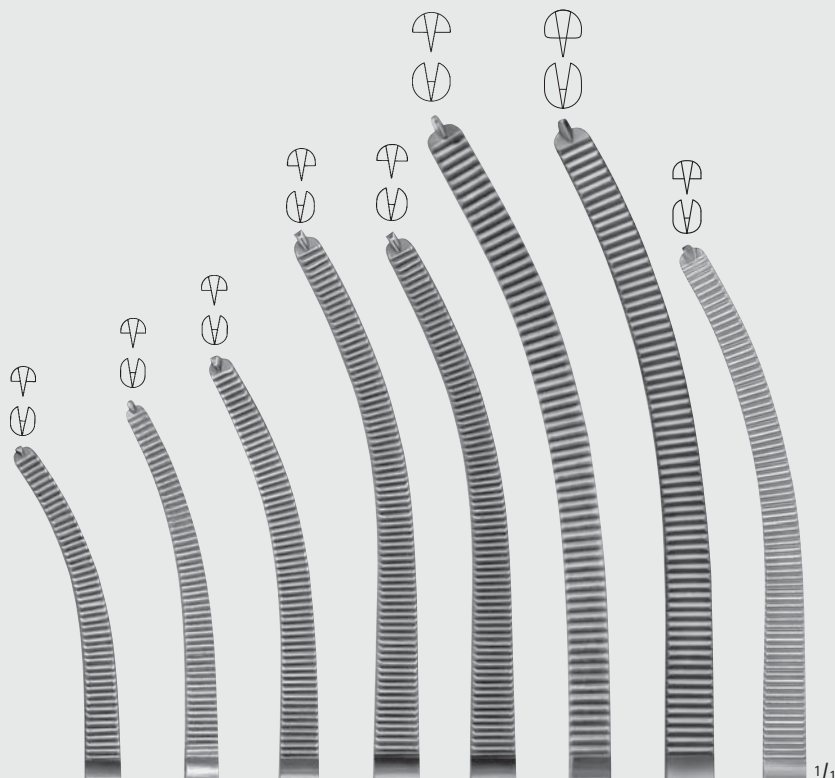

BH643R	BH645R	BH647R	BH649R	BH651R	BH653R	BH655R	BH659R
160 mm	185 mm	200 mm	225 mm	240 mm	260 mm	280 mm	350 mm
6 1/4"	7 1/4"	8"	9"	9 1/2"	10 1/4"	11"	14"

INCHES



Arterienklemmen – Hemostatic Forceps

Arterienklemmen, Spezial-Modelle
Hemostatic Forceps, Special Patterns

BH

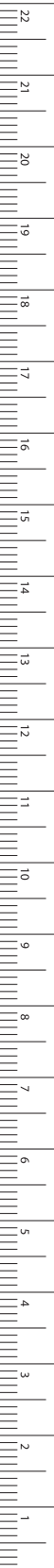

MILLIMETERS

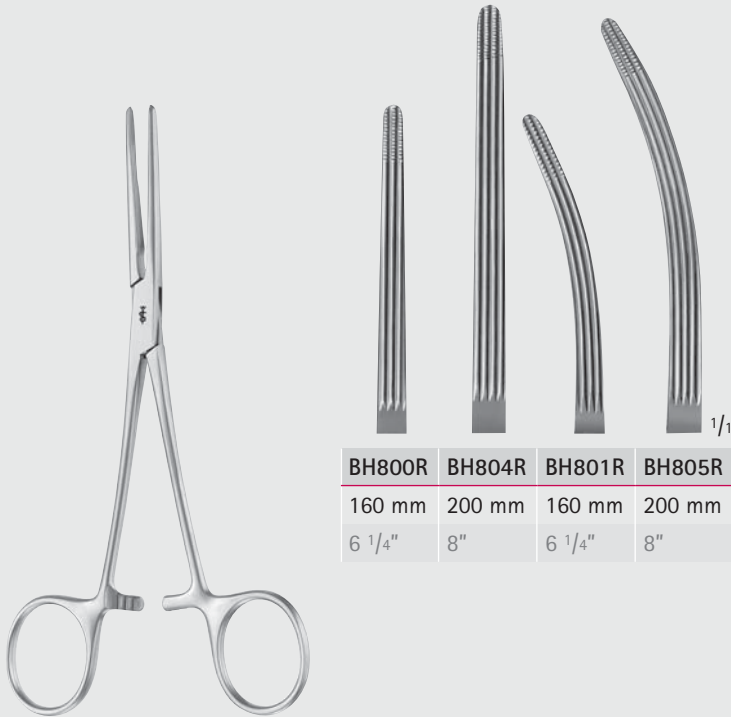

BH800R	BH804R	BH801R	BH805R
160 mm	200 mm	160 mm	200 mm
6 1/4"	8"	6 1/4"	8"

ROCHESTER-CARMALT

BH800R-BH805R

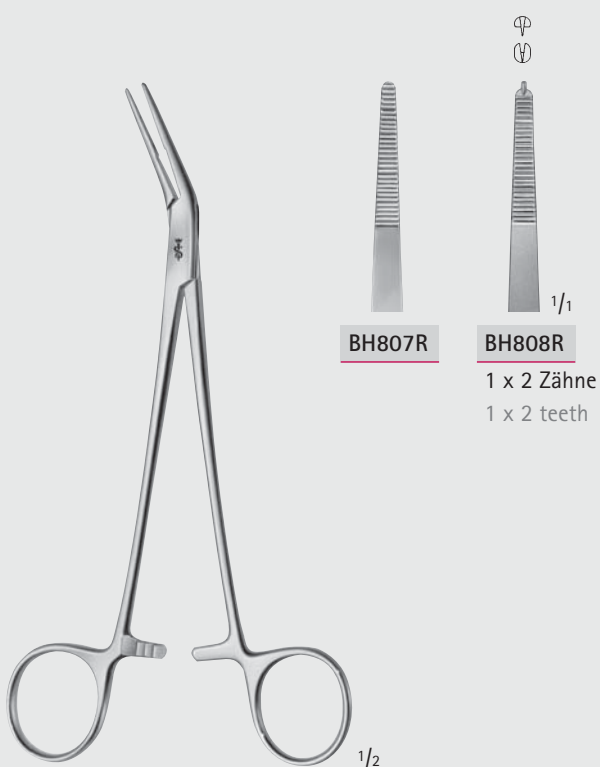

BH807R

BH808R

1 x 2 Zähne
1 x 2 teeth

FICKLING

BH807R-BH808R

180 mm, 7"

Arterienklemmen – Hemostatic Forceps

Arterienklemmen, Spezial-Modelle

Hemostatic Forceps, Special Patterns

BH

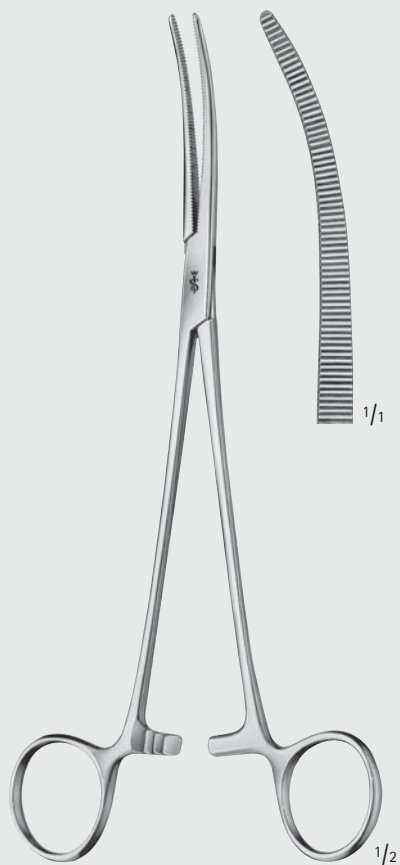

ROBERTS

BH814R

225 mm, 9"



ROBERTS

BH812R-BH813R

250 mm, 10"



SAROT

BH226R

250 mm, 9 3/4"



Arterienklemmen – Hemostatic Forceps

Arterienklemmen, Spezial-Modelle
Hemostatic Forceps, Special Patterns

BH

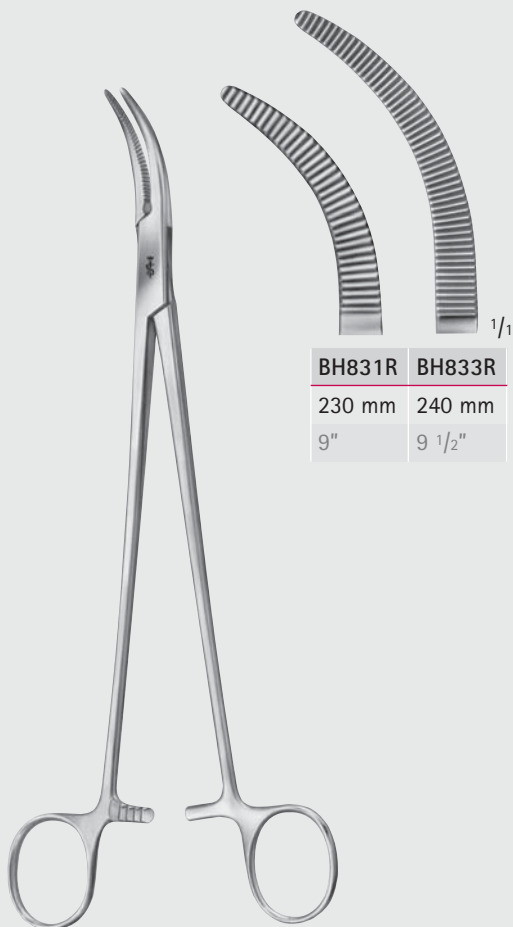

BH831R	BH833R
230 mm	240 mm
9"	9 1/2"

MOYNIHAN

BH831R-BH833R

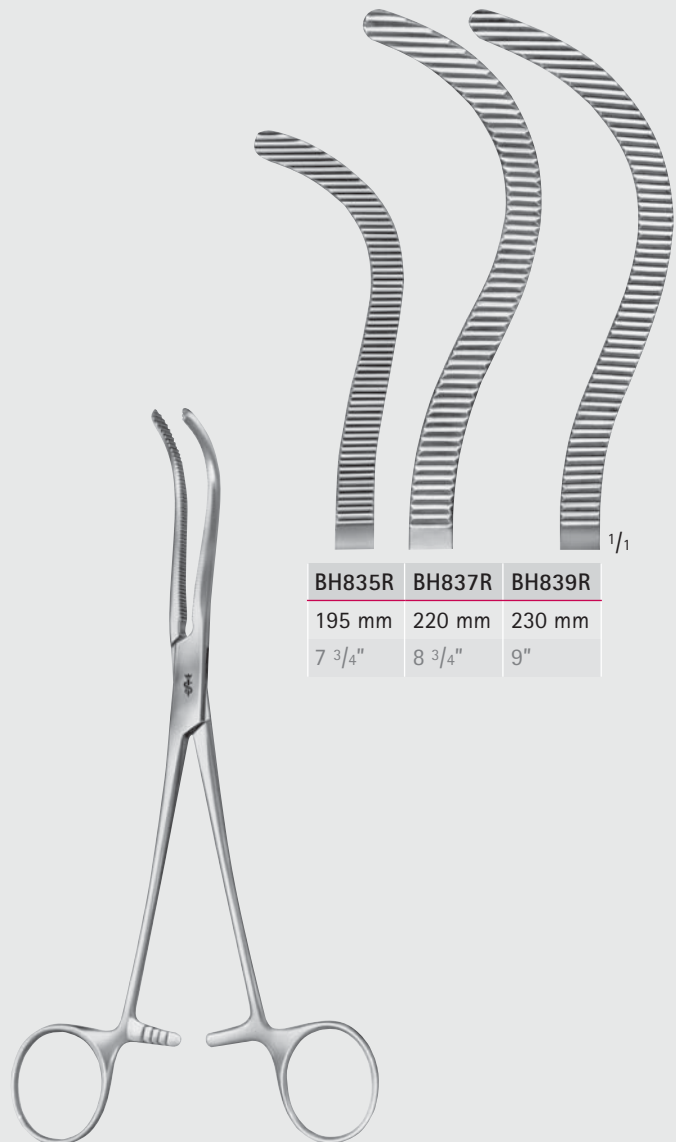

BH835R	BH837R	BH839R
195 mm	220 mm	230 mm
7 3/4"	8 3/4"	9"

PEAN

BH835R-BH839R



MILLIMETERS

Arterienklemmen – Hemostatic Forceps

Arterienklemmen, Tonsillenklemmen

Hemostatic Forceps, Tonsil Forceps

BH

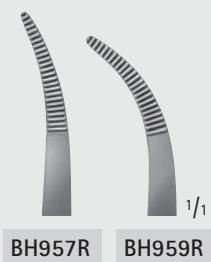

BH957R BH959R

SCHNIDT

BH957R-BH959R

185 mm, 7 1/4"

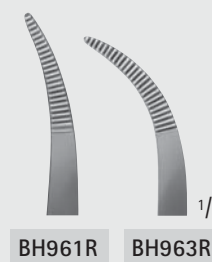

BH961R BH963R

SCHNIDT

BH961R-BH963R

185 mm, 7 1/4"

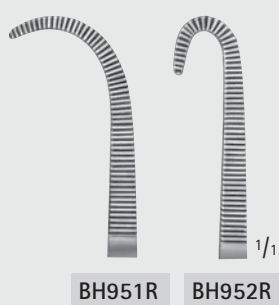

BH951R BH952R

NEGUS

BH951R-BH952R

190 mm, 7 1/2"

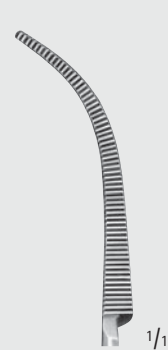
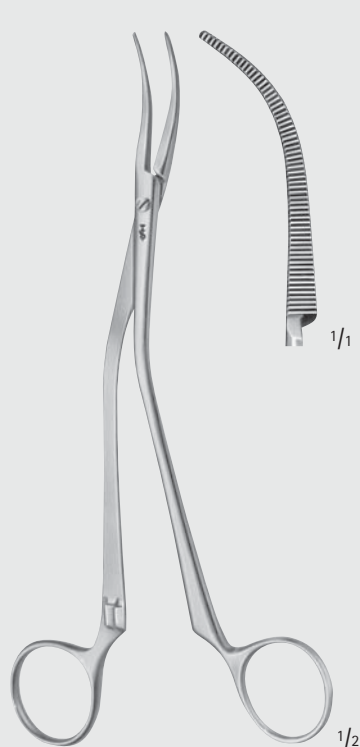

BH965R

WILSON

BH965R

190 mm, 7 1/2"



BH949R

MIKULICZ

BH949R

185 mm, 7 1/4"



Arterienklemmen – Hemostatic Forceps

Arterienklemmen, Spezial-Modelle
Hemostatic Forceps, Special Patterns

BH

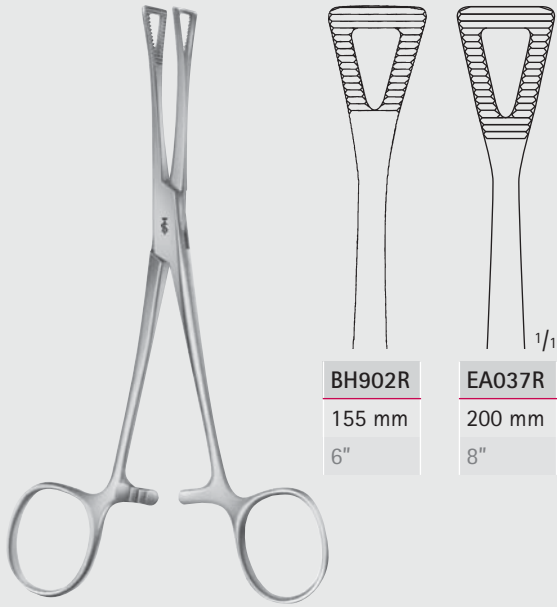

BH902R
155 mm
6"

EA037R
200 mm
8"

PENNINGTON

BH902R-EA037R

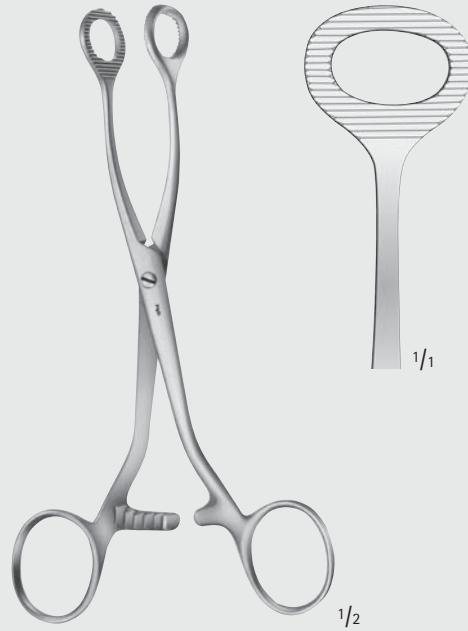

COLLIN

BH906R

160 mm, 6 1/4"

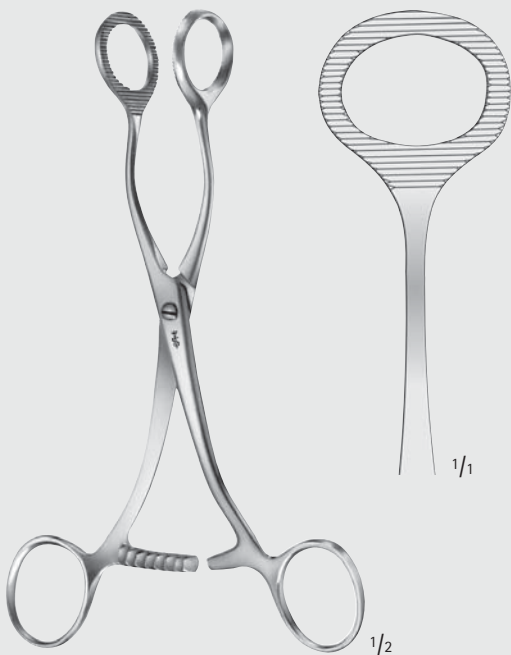

COLLIN

AN709R

170 mm, 6 3/4"

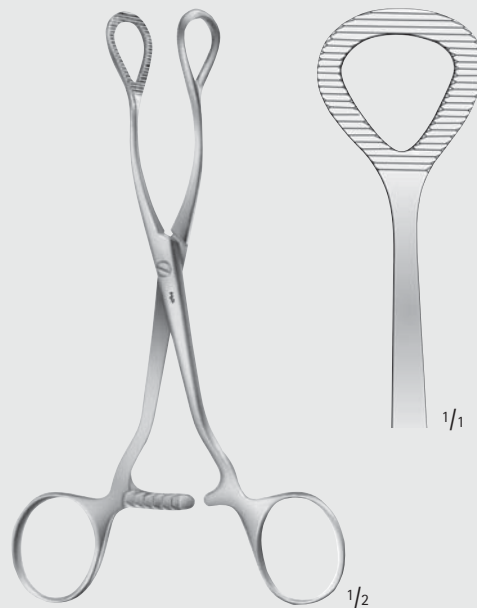

COLLIN

BH908R

160 mm, 6 1/4"

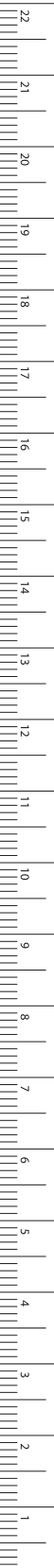

MILLIMETERS

Cardiovascular

Vascular Clamps

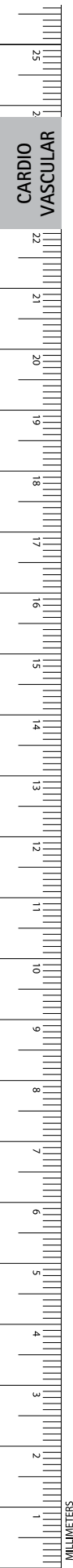

CARDIO
VASCULAR

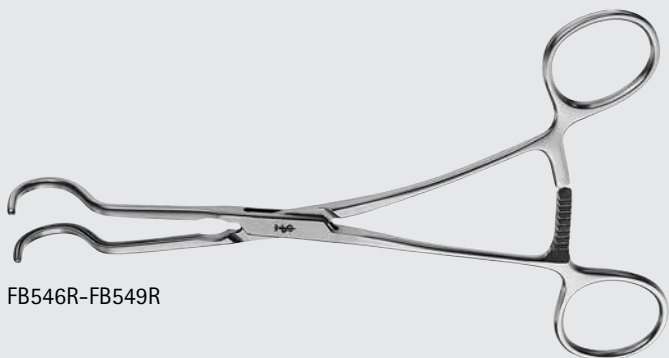

FB546R-FB549R

DALE Femoral Popliteal Clamp

Catalog Number	Jaw	Length (in.)
FB546R	SMALL	6 7/8
FB547R	MEDIUM	7
FB548R	LARGE	7
FB549R	-	7

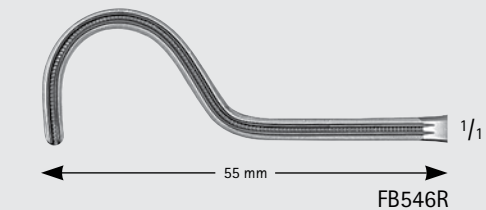

FB546R

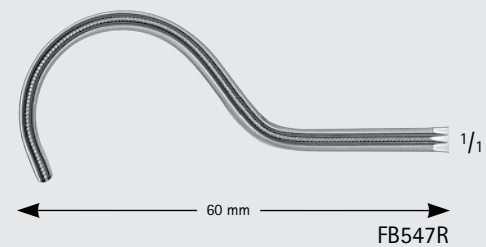

FB547R

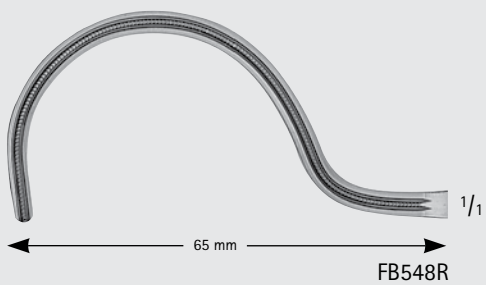

FB548R

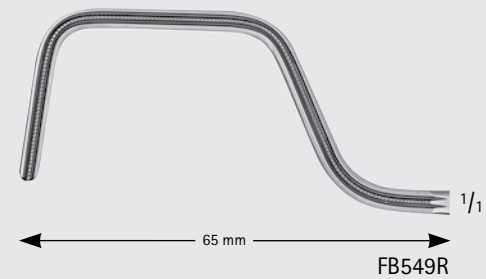

FB549R



Arterienklemmen – Hemostatic Forceps

Feine Arterienklemmen

Delicate Hemostatic Forceps

BH

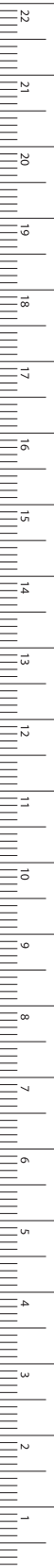

MILLIMETERS

JACOBSON
BH106R-MB229R
 125 mm, 5"

PROVIDENCE-HOSPITAL
BH130R-BH131R
 140 mm, 5 1/2"

KELLY
BH134R-BH135R
 140 mm, 5 1/2"

DANDY
BH139R-BH143R
 seitwärts gebogen
 curved to side
 140 mm, 5 1/2"

Arterienklemmen – Hemostatic Forceps

Feine Arterienklemmen

Delicate Hemostatic Forceps

BH



BH164R

BH165R

1/2

RANKIN

BH164R-BH165R

160 mm, 6 1/4"

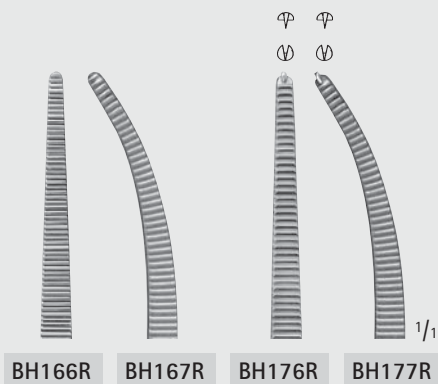

BH166R

BH167R

BH176R

BH177R

1/2

CRILE

BH166R-BH177R

160 mm, 6 1/4"



MD464

140 mm

5 1/2"

MD466R

165 mm

6 1/2"

MD468

185 mm

7 1/4"

MD465R

140 mm

5 1/2"

MD467R

165 mm

6 1/2"

MD469

185 mm

7 1/4"

COLLER

MD464-MD469

**XG120R**

HAEMOSTATIC FORCEPS CVD.125MM

Data Matrix	No
Sterility	non-sterile
Disposable /	
Reusable	reusable

**XG239R**

HAEMOSTATIC FORCEPS CVD.140MM

Data Matrix	No
Sterility	non-sterile
Disposable /	
Reusable	reusable

**XG249R**

HAEMOSTATIC FORCEPS CVD.180MM

Data Matrix	No
Sterility	non-sterile
Disposable /	
Reusable	reusable



XJ163R

KELLY Hemostatic Forceps, strongly curved, 200 mm, japanese design



Data Matrix	Yes
Sterility	non-sterile
Disposable /	
Reusable	reusable



XJ162R

KELLY Hemostatic Forceps, strongly curved, 170 mm, japanese design



Data Matrix	Yes
Sterility	non-sterile
Disposable /	
Reusable	reusable



XJ155R

KELLY Hemostatic Forceps, slightly curved, 190 mm, japanese design, no teeth

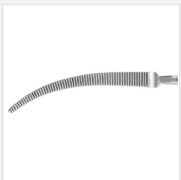

Data Matrix	Yes
Sterility	non-sterile
Product contains	
Latex	No
Disposable /	
Reusable	reusable



XJ156R

KELLY Hemostatic Forceps, curved, 190 mm, japanese design, no teeth

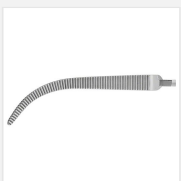

Data Matrix	Yes
Sterility	non-sterile
Disposable /	
Reusable	reusable



XJ157R

KELLY Hemostatic Forceps, strongly curved, 190 mm, japanese design, no teeth



Data Matrix	Yes
Sterility	non-sterile
Disposable /	
Reusable	reusable



XJ158R

KELLY Hemostatic Forceps, slightly curved, 220 mm, japanese design, no teeth



Data Matrix	Yes
Sterility	non-sterile
Product contains	
Latex	No
Disposable /	
Reusable	reusable



XJ159R

KELLY Hemostatic Forceps, curved, 220 mm, japanese design, no teeth



Data Matrix	Yes
Sterility	non-sterile
Disposable /	
Reusable	reusable



XJ160R

KELLY Hemostatic Forceps, strongly curved, 220 mm, japanese design, no teeth



Data Matrix	Yes
Sterility	non-sterile
Product contains	
Latex	No
Disposable /	
Reusable	reusable



XJ151R

PEAN Hemostatic Forceps, straight, 145 mm, japanese design, no teeth



Data Matrix	Yes
Sterility	non-sterile
Product contains	
Latex	No
Disposable /	
Reusable	reusable



XJ152R

PEAN Hemostatic Forceps, curved, 145 mm, japanese design, no teeth, Fig. 1

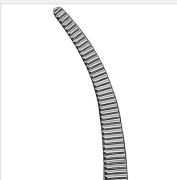

Data Matrix	Yes
Sterility	non-sterile
Product contains	
Latex	No
Disposable /	
Reusable	reusable

ROCHESTER-CARMALT Forceps

Catalog Number	Jaw	Length (in.)
BH800R	STR	6 1/4
BH804R	STR	7 7/8
MG196R	STR	9
MG431R	STR	10 1/4
BH801R	CVD	6 1/4
BH805R	CVD	7 7/8
MG197R	CVD	9
MG432R	CVD	10 1/4

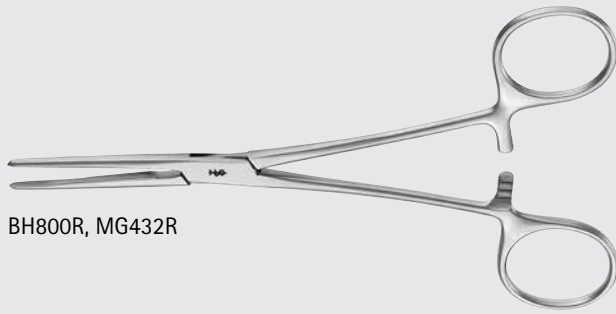

BH800R, MG432R



BH800R



BH804R



MG196R



MG431R



BH801R



BH805R



MG197R



MG432R

STOREY Forceps

Catalog Number	Tip	Length (in.)
MG353R	STRONG-CVD	8 3/4
MG354R	RIGHT-ANG	8 3/4

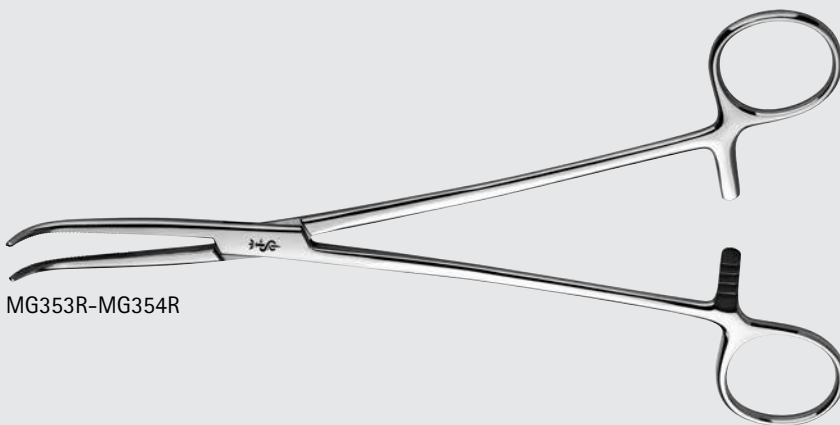

MG353R-MG354R

1/2



MG353R



MG354R

Arterienklemmen – Hemostatic Forceps

Feine Arterieklemmen

Delicate Hemostatic Forceps

BH



CARREL

BH100R

85 mm, 3 3/8"

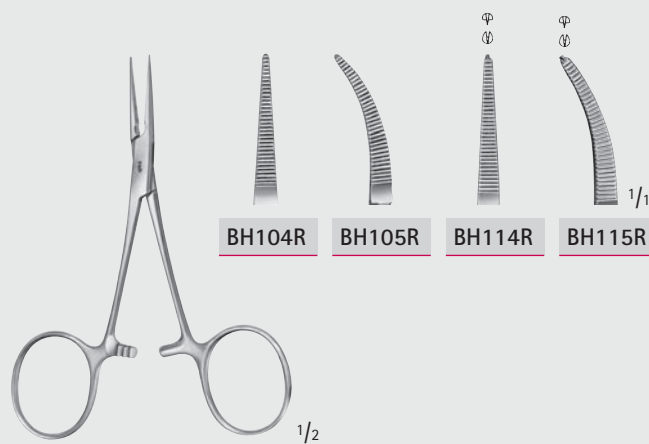

BABY-MOSQUITO
(HARTMANN)

BH104R-BH115R

100 mm, 4"

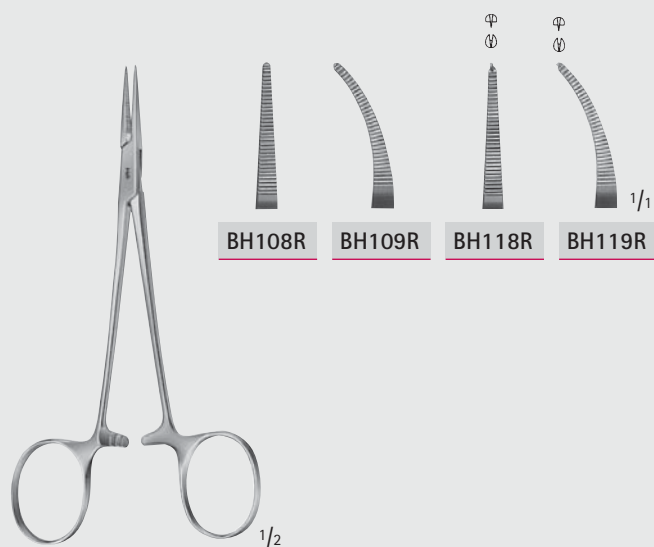

MICRO-HALSTED

BH108R-BH119R

125 mm, 5"

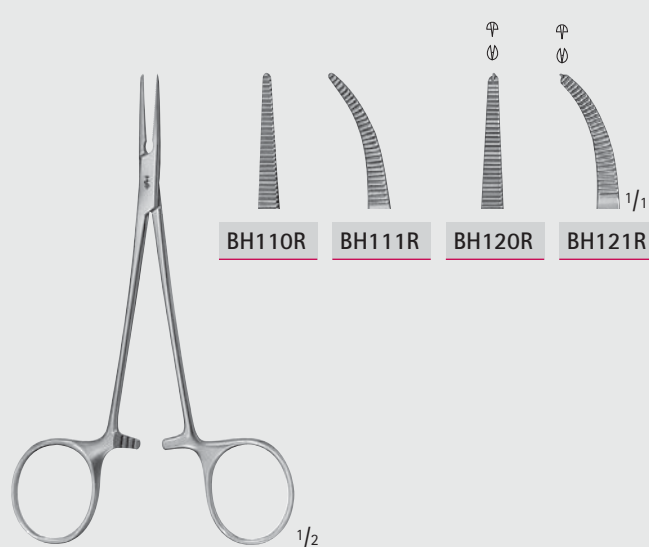

HALSTED-MOSQUITO

BH110R-BH121R

125 mm, 5"

Arterienklemmen – Hemostatic Forceps

Feine Arterienklemmen

Delicate Hemostatic Forceps

BH

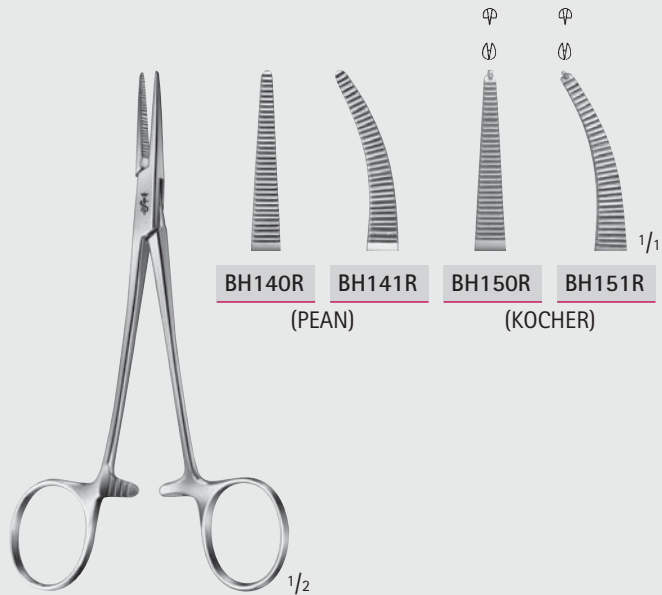

BH140R

BH141R

BH150R

BH151R

(PEAN)

(KOCHER)

BABY-CRILE

BH140R-BH151R

140 mm, 5 1/2"

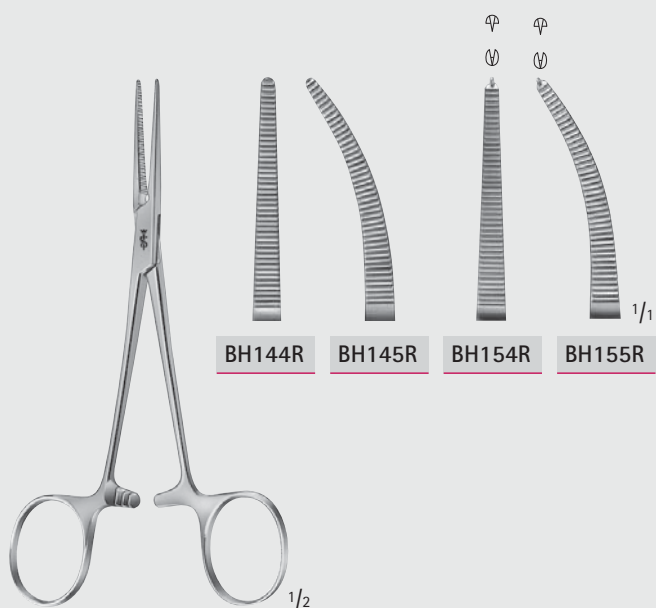

BH144R

BH145R

BH154R

BH155R

CRILE

BH144R-BH155R

140 mm, 5 1/2"



DUNHILL

BH123R

125 mm, 5"



Arterienklemmen – Hemostatic Forceps

Feine Arterienklemmen

Delicate Hemostatic Forceps

BH



CAIRNS

BH124R-BH125R

150 mm, 6"

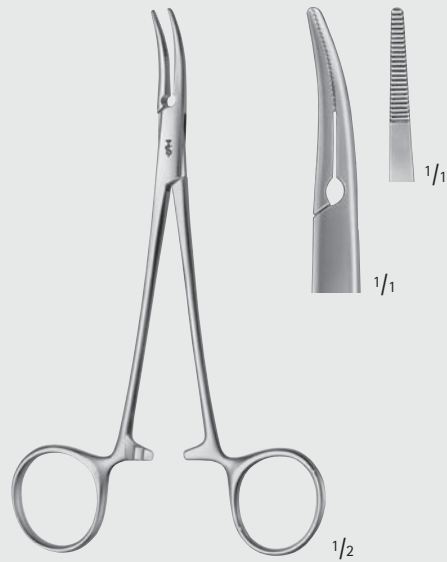

CAIRNS

BH126R

seitwärts gebogen
curved to side
145 mm, 5 3/4"

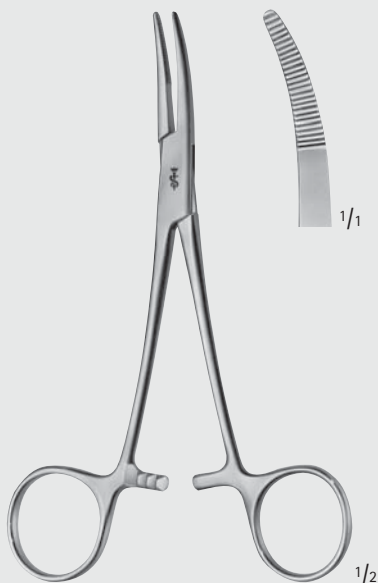

MOYNIHAN

BH127R

150 mm, 6"

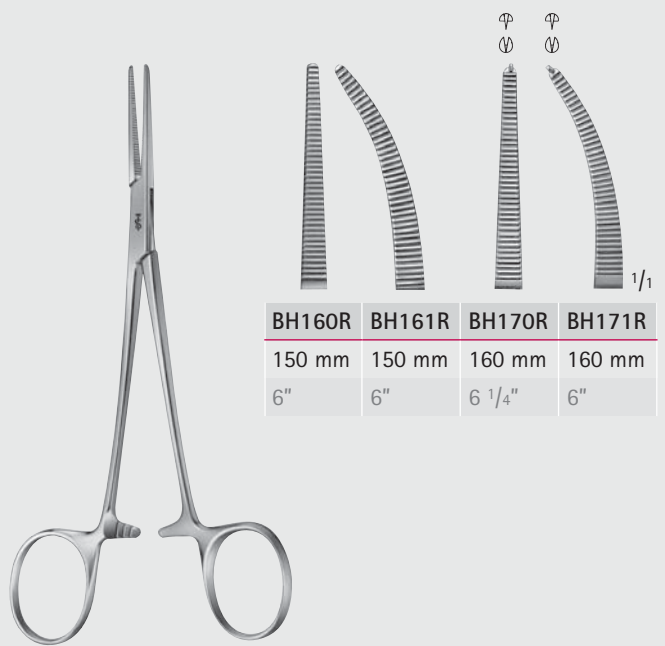

LERICHE

BH160R-BH171R

BH160R	BH161R	BH170R	BH171R
150 mm	150 mm	160 mm	160 mm
6"	6"	6 1/4"	6"



MILLIMETERS

Arterienklemmen – Hemostatic Forceps

Feine Arterienklemmen

Delicate Hemostatic Forceps

BH

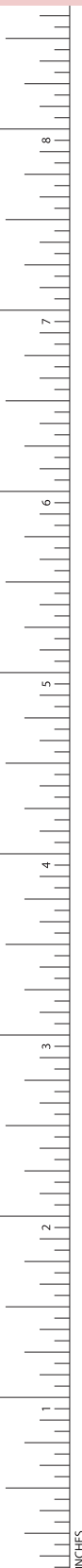

BH164R BH165R

1/2

RANKIN

BH164R-BH165R

160 mm, 6 1/4"

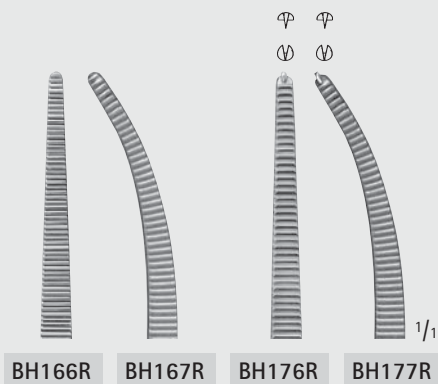

BH166R BH167R BH176R BH177R

1/2

CRILE

BH166R-BH177R

160 mm, 6 1/4"

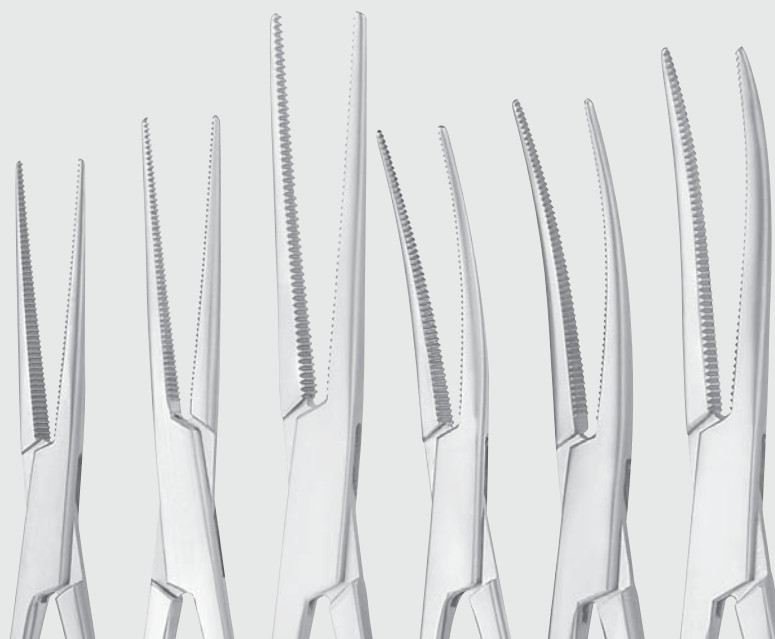

MD464	MD466R	MD468	MD465R	MD467R	MD469
140 mm	165 mm	185 mm	140 mm	165 mm	185 mm
5 1/2"	6 1/2"	7 1/4"	5 1/2"	6 1/2"	7 1/4"

COLLER

MD464-MD469

INCHES



Arterienklemmen – Hemostatic Forceps

Feine Arterienklemmen

Delicate Hemostatic Forceps

BH



BH168R

BH178R

DIXON-LOVELACE

BH168R-BH178R

160 mm, 6 1/4"



FUCHSIG

BH198R

195 mm, 7 3/4"

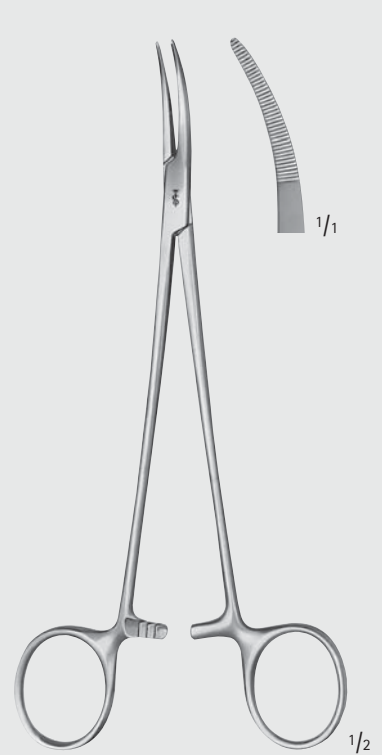

NISSEN

BH199R

185 mm, 7 1/4"

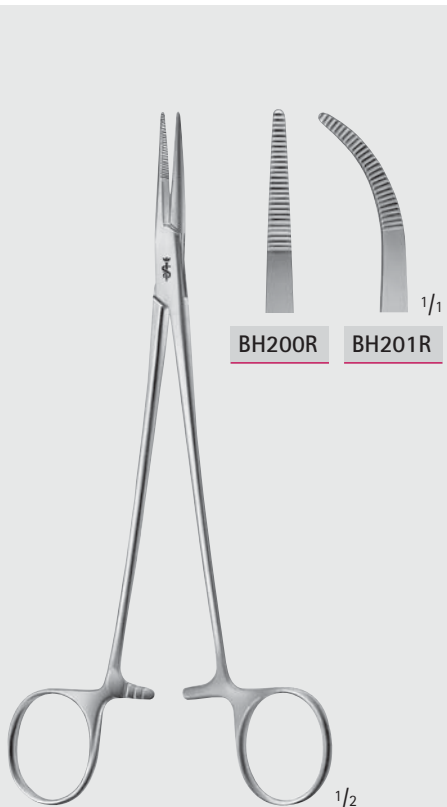

BH200R

BH201R

ADSON

BH200R-BH201R

185 mm, 7 1/4"

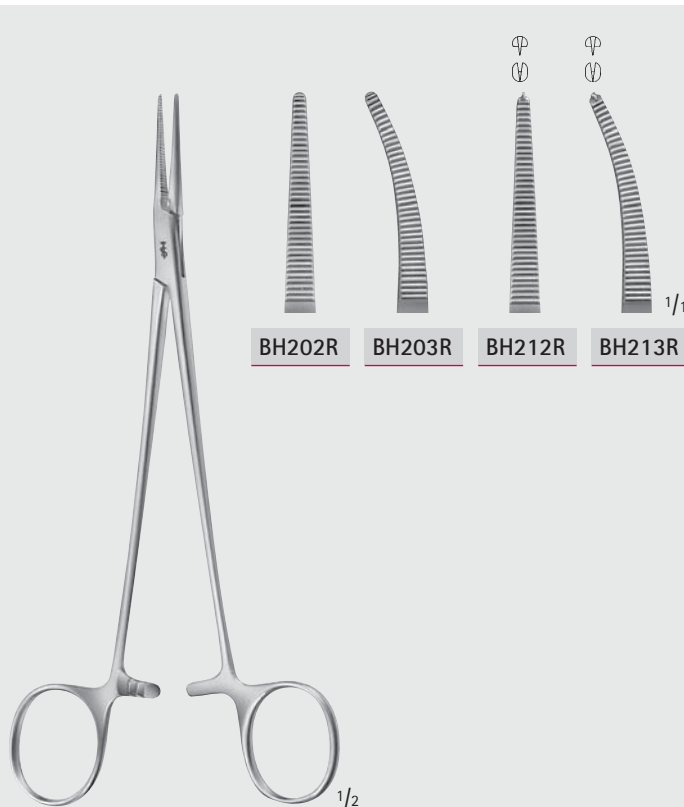

BH202R

BH203R

BH212R

BH213R

HALSTED

BH202R-BH213R

185 mm, 7 1/4"

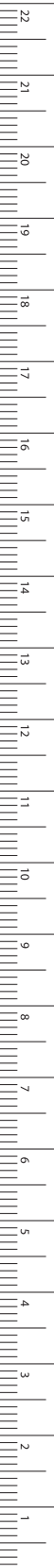

Arterienklemmen – Hemostatic Forceps

Feine Arterienklemmen

Delicate Hemostatic Forceps

BH



BH210R

BH211R

BH214R

BH215R

1/2

HALSTED-MOSQUITO

BH210R-BH215R

200 mm, 8"

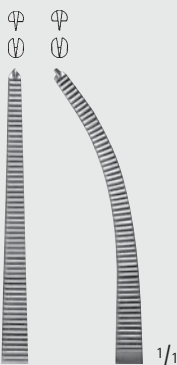

1/1

1/2

JACOBSON

BH187R

190 mm, 7 1/2"



1/1

1/2

ADSON

BH205R

215 mm, 8 1/2"



1/1

1/2

FRASER-KELLY (CRILE)

BH183R

180 mm, 7"



Arterienklemmen – Hemostatic Forceps

Feine Arterienklemmen

Delicate Hemostatic Forceps

BH

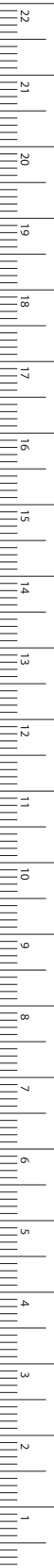

DUNHILL

BH191R

190 mm, 7 1/2"

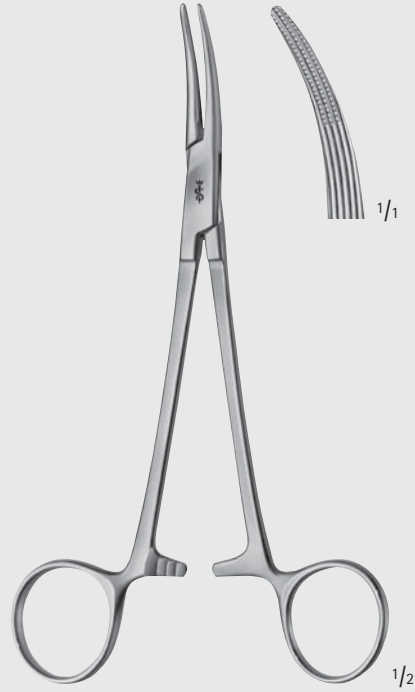

GREY-TURNER

BH193R

180 mm, 7"

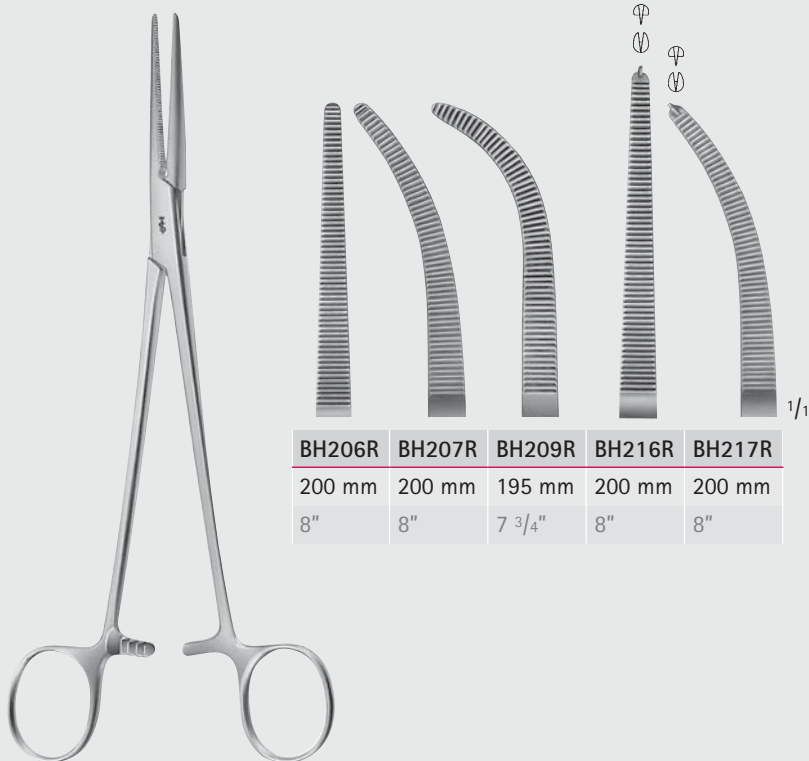

HEISS

BH206R-BH217R

BH206R	BH207R	BH209R	BH216R	BH217R
200 mm	200 mm	195 mm	200 mm	200 mm
8"	8"	7 3/4"	8"	8"

Arterienklemmen – Hemostatic Forceps

Feine Arterienklemmen

Delicate Hemostatic Forceps

BH



BH196R

BH197R ^{1/1}

^{1/2}

BIRKETT

BH196R-BH197R

185 mm, 7 1/4"

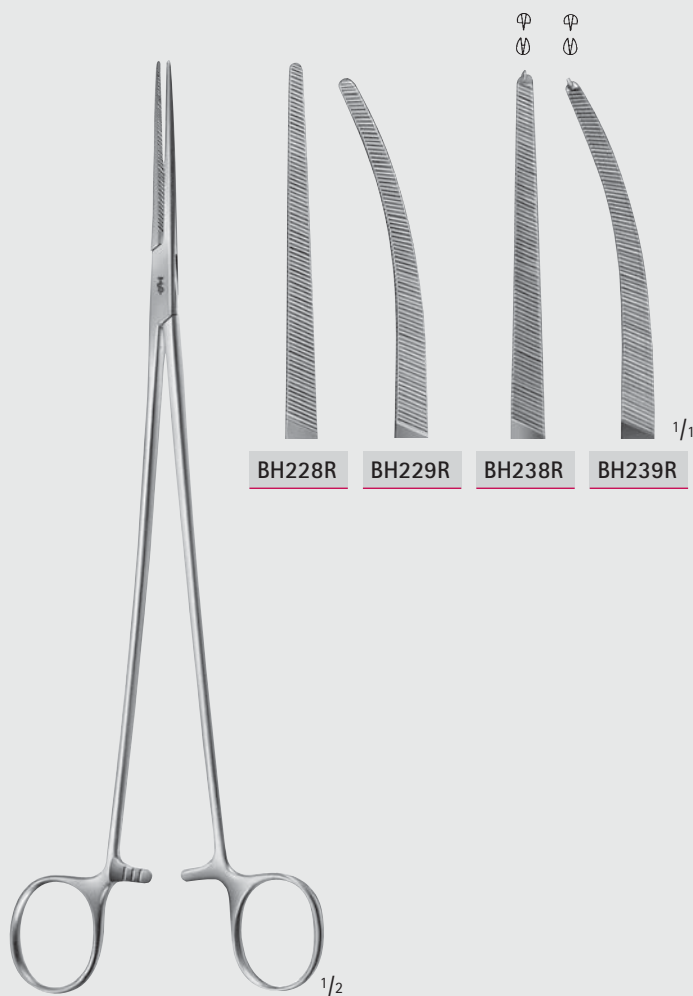

BH228R

BH229R

BH238R

BH239R ^{1/1}

^{1/2}

BENGOLEA

BH228R-BH239R

245 mm, 9 3/4"



Arterienklemmen – Hemostatic Forceps

Feine Arterienklemmen
Delicate Hemostatic Forceps

BH

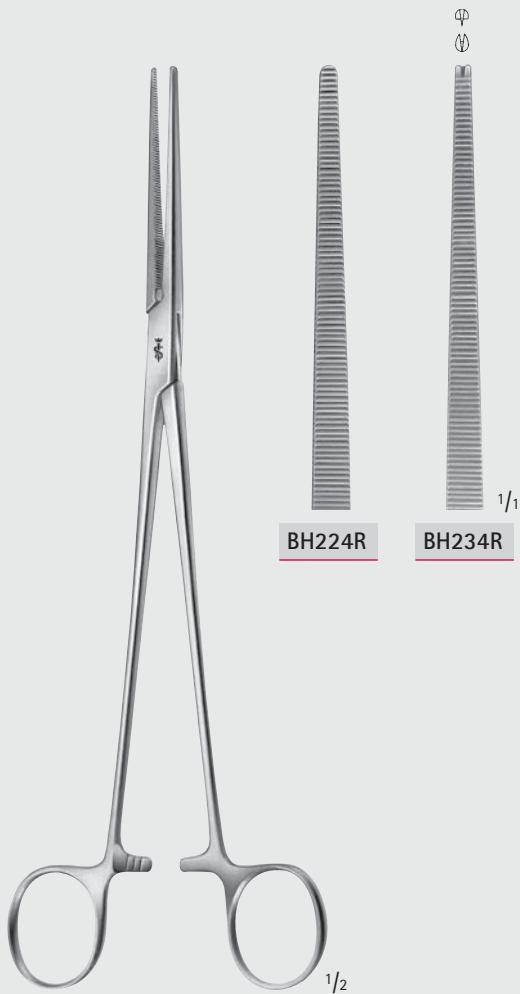

SAROT

BH224R-BH234R

240 mm, 9 1/2"



CRAFOORD

BH225R

245 mm, 9 3/4"

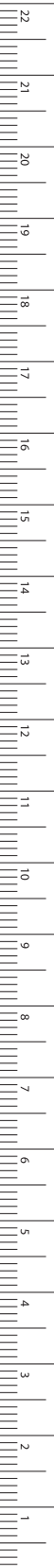

Arterienklemmen – Hemostatic Forceps

Feine Arterienklemmen

Delicate Hemostatic Forceps

BH

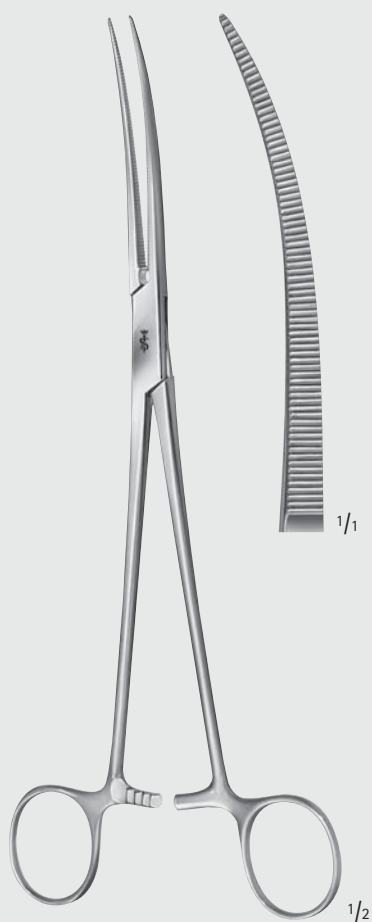

CRAFOORD, MOD.

BH227R

240 mm, 9 1/2"

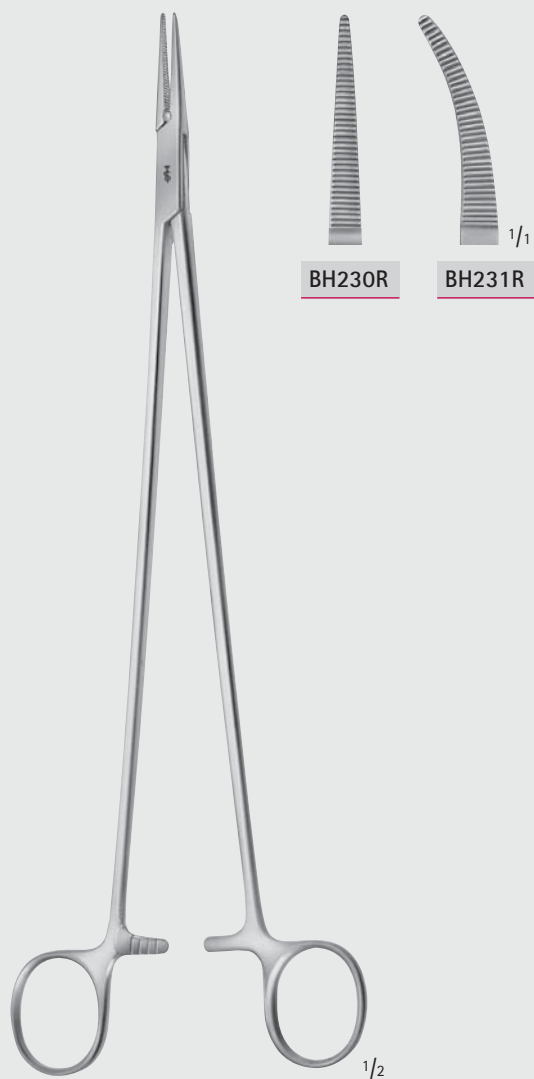

BRIDGE

BH230R-BH231R

275 mm, 10 3/4"

По вопросам продаж и поддержки обращайтесь:

Алматы (7273)495-231	Казань (843)206-01-48	Новокузнецк (3843)20-46-81	Смоленск (4812)29-41-54
Архангельск (8182)63-90-72	Калининград (4012)72-03-81	Новосибирск (383)227-86-73	Сочи (862)225-72-31
Астрахань (8512)99-46-04	Калуга (4842)92-23-67	Омск (3812)21-46-40	Ставрополь (8652)20-65-13
Барнаул (3852)73-04-60	Кемерово (3842)65-04-62	Орел (4862)44-53-42	Сургут (3462)77-98-35
Белгород (4722)40-23-64	Киров (8332)68-02-04	Оренбург (3532)37-68-04	Тверь (4822)63-31-35
Брянск (4832)59-03-52	Краснодар (861)203-40-90	Пенза (8412)22-31-16	Томск (3822)98-41-53
Владивосток (423)249-28-31	Красноярск (391)204-63-61	Пермь (342)205-81-47	Тула (4872)74-02-29
Волгоград (844)278-03-48	Курск (4712)77-13-04	Ростов-на-Дону (863)308-18-15	Тюмень (3452)66-21-18
Вологда (8172)26-41-59	Липецк (4742)52-20-81	Рязань (4912)46-61-64	Ульяновск (8422)24-23-59
Воронеж (473)204-51-73	Магнитогорск (3519)55-03-13	Самара (846)206-03-16	Уфа (347)229-48-12
Екатеринбург (343)384-55-89	Москва (495)268-04-70	Санкт-Петербург (812)309-46-40	Хабаровск (4212)92-98-04
Иваново (4932)77-34-06	Мурманск (8152)59-64-93	Саратов (845)249-38-78	Челябинск (351)202-03-61
Ижевск (3412)26-03-58	Набережные Челны (8552)20-53-41	Севастополь (8692)22-31-93	Череповец (8202)49-02-64
Иркутск (395)279-98-46	Нижний Новгород (831)429-08-12	Симферополь (3652)67-13-56	Ярославль (4852)69-52-93
Россия (495)268-04-70	Киргизия (996)312-96-26-47	Казахстан (7172)727-132	