

# DUROTIP

## Технические характеристики

### По вопросам продаж и поддержки обращайтесь:

Алматы (7273)495-231	Казань (843)206-01-48	Новокузнецк (3843)20-46-81	Смоленск (4812)29-41-54
Архангельск (8182)63-90-72	Калининград (4012)72-03-81	Новосибирск (383)227-86-73	Сочи (862)225-72-31
Астрахань (8512)99-46-04	Калуга (4842)92-23-67	Омск (3812)21-46-40	Ставрополь (8652)20-65-13
Барнаул (3852)73-04-60	Кемерово (3842)65-04-62	Орел (4862)44-53-42	Сургут (3462)77-98-35
Белгород (4722)40-23-64	Киров (8332)68-02-04	Оренбург (3532)37-68-04	Тверь (4822)63-31-35
Брянск (4832)59-03-52	Краснодар (861)203-40-90	Пенза (8412)22-31-16	Томск (3822)98-41-53
Владивосток (423)249-28-31	Красноярск (391)204-63-61	Пермь (342)205-81-47	Тула (4872)74-02-29
Волгоград (844)278-03-48	Курск (4712)77-13-04	Ростов-на-Дону (863)308-18-15	Тюмень (3452)66-21-18
Вологда (8172)26-41-59	Липецк (4742)52-20-81	Рязань (4912)46-61-64	Ульяновск (8422)24-23-59
Воронеж (473)204-51-73	Магнитогорск (3519)55-03-13	Самара (846)206-03-16	Уфа (347)229-48-12
Екатеринбург (343)384-55-89	Москва (495)268-04-70	Санкт-Петербург (812)309-46-40	Хабаровск (4212)92-98-04
Иваново (4932)77-34-06	Мурманск (8152)59-64-93	Саратов (845)249-38-78	Челябинск (351)202-03-61
Ижевск (3412)26-03-58	Набережные Челны (8552)20-53-41	Севастополь (8692)22-31-93	Череповец (8202)49-02-64
Иркутск (395)279-98-46	Нижний Новгород (831)429-08-12	Симферополь (3652)67-13-56	Ярославль (4852)69-52-93
Россия (495)268-04-70	Киргизия (996)312-96-26-47	Казахстан (7172)727-132	

## Scheren – Scissors

DUROTIP® Feine Scheren

DUROTIP® Delicate Scissors



DUROTIP®-Scheren  
mit eingesetzten Hartmetall-Schneiden

- 3 Jahre Garantie!
- Hervorragende Schnitthaltigkeit
- Lange Lebensdauer
- Vergoldete Ring

DUROTIP® Scissors  
with inserted carbide cutting edges

- 3 years guarantee!
- Excellent cutting accuracy
- Long working life
- Gold-plated rings

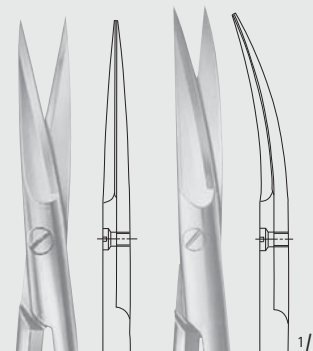

BC210R

BC211R



BC210R-BC211R

Fadenscheren  
Ligature scissors  
110 mm, 4 3/8"

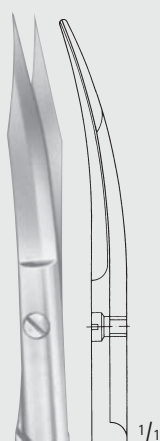

1 Schneide gezahnt  
1 blade serrated



GOLDMAN-FOX

DO250R

130 mm, 5 1/8"

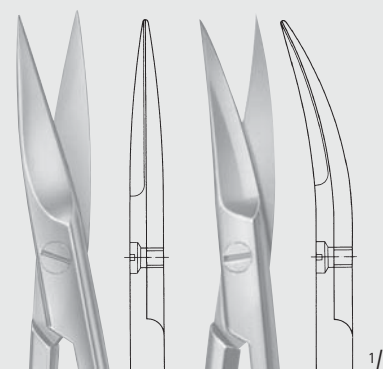

DO208R

DO209R



DO208R-DO209R

120 mm, 4 3/4"

BC



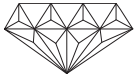

**Scheren – Scissors**  
 DUROTIP® Chirurgische Scheren  
 DUROTIP® Surgical Scissors

**BC**

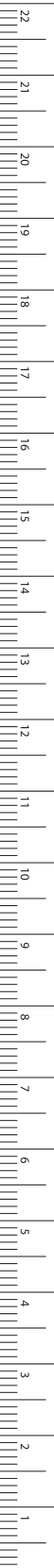

**BC224R**

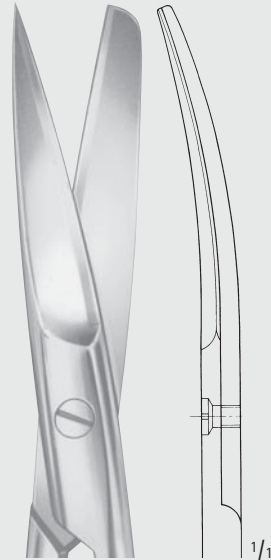

**BC234R**

**BC224R-BC234R**  
 145 mm, 5 3/4"

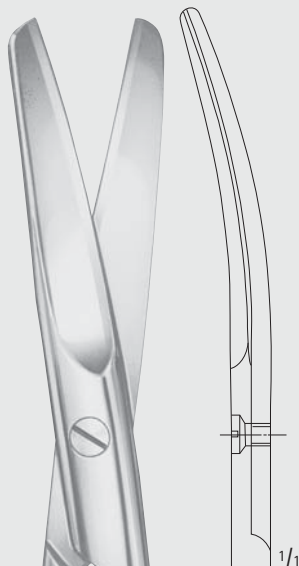

**BC231R**  
 145 mm, 5 3/4"

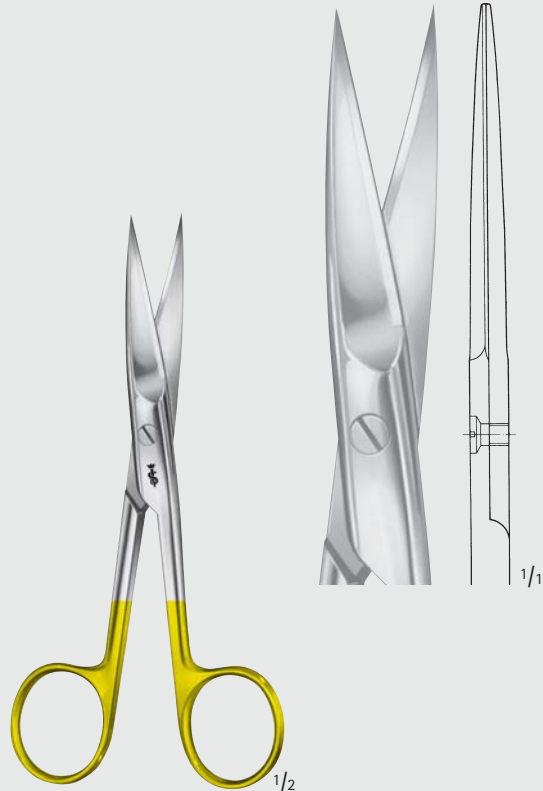

**BC228R**  
 145 mm, 5 3/4"

MILLIMETERS

## Scheren – Scissors

DUROTIP® Präparierscheren

DUROTIP® Dissecting Scissors

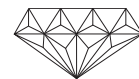

BC



MAYO

BC250R-BC253R

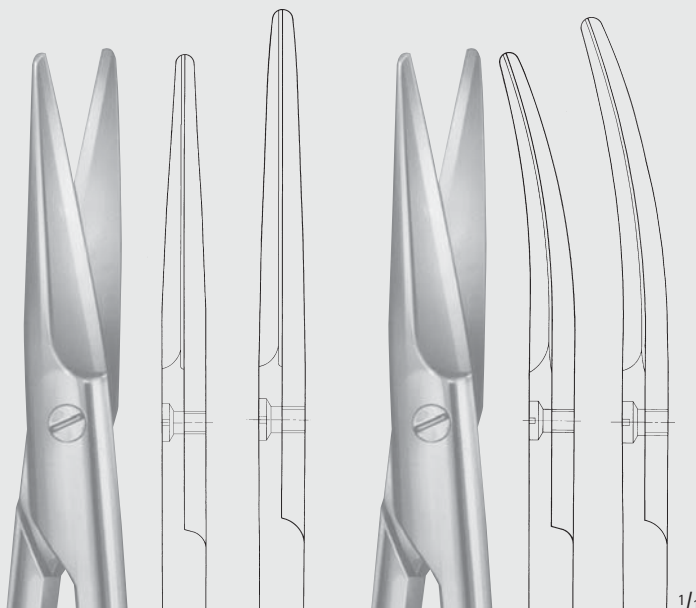

BC250R	BC252R
140 mm	170 mm
5 1/2"	6 3/4"

BC251R	BC253R
140 mm	170 mm
5 1/2"	6 3/4"



MAYO

BC242R-BC559R

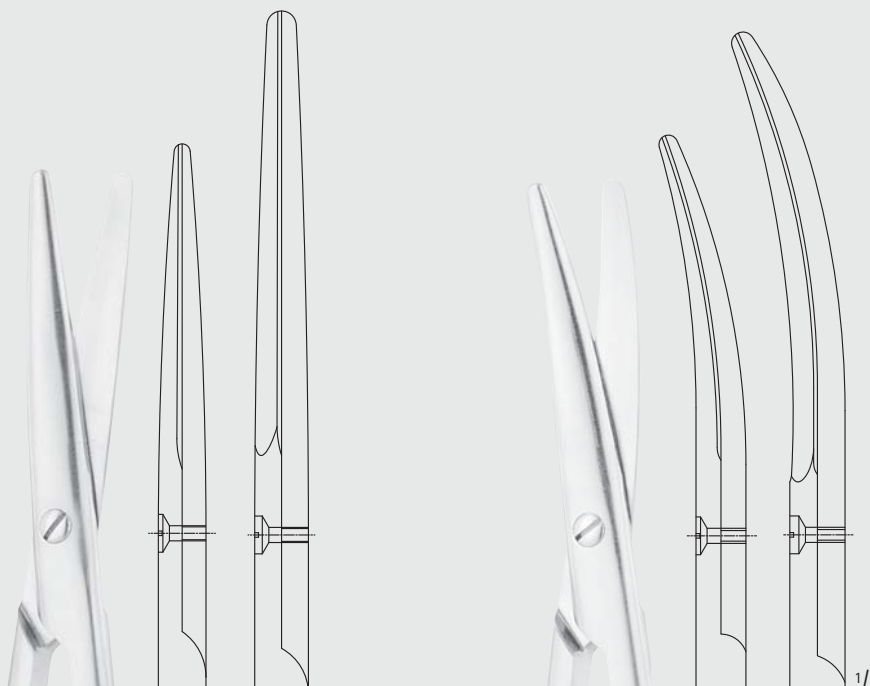

BC242R	BC558R
170 mm	230 mm
6 3/4"	9"

BC243R	BC559R
170 mm	230 mm
6 3/4"	9"



**Scheren – Scissors**  
**DUROTIP® Präparierscheren**  
**DUROTIP® Dissecting Scissors**

**BC**

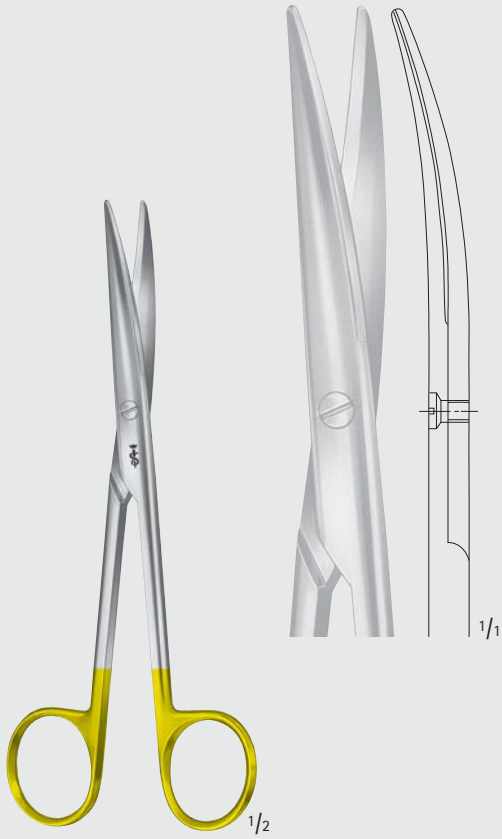

LEXER

**BC283R**

schmal  
 narrow

165 mm, 6 1/2"

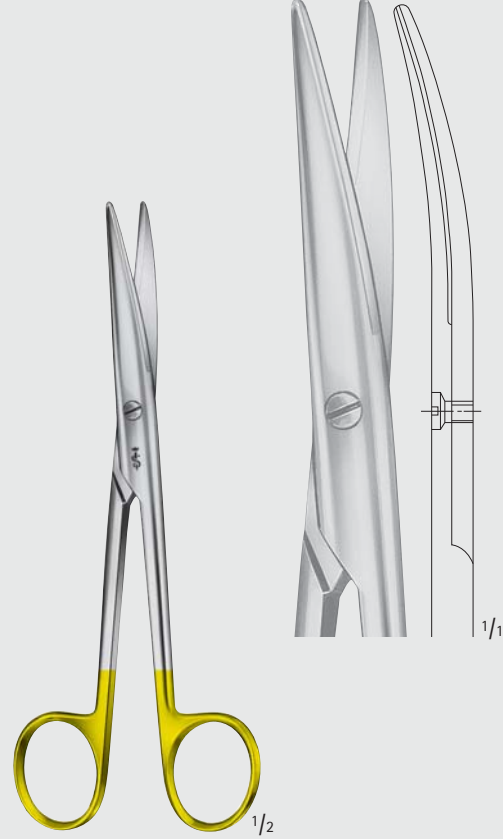

MAYO-LEXER

**BC284R**

165 mm, 6 1/2"

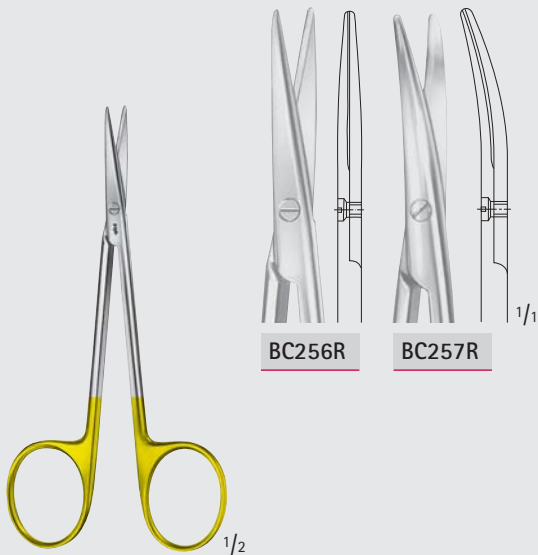

**BC256R**

**BC257R**

**BC256R-BC257R**

115 mm, 4 1/2"

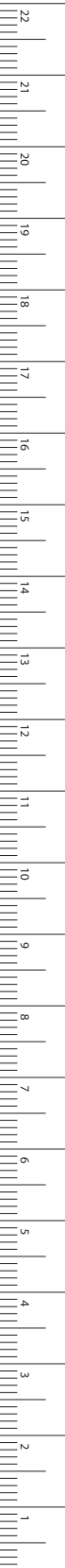

MILLIMETERS

## Scheren – Scissors

DUROTIP® Präparierscheren

DUROTIP® Dissecting Scissors

»grazil«

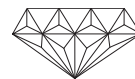

BC



1/2

BABY-METZENBAUM

BC258R-BC259R

145 mm, 5 3/4"

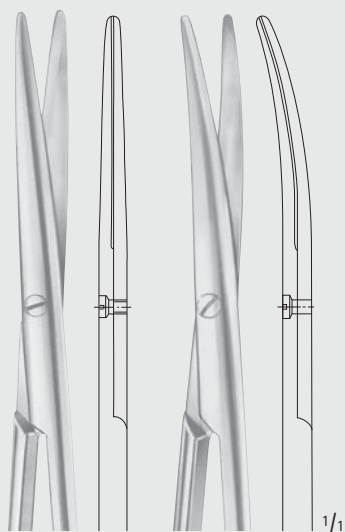

BC258R

BC259R

1/1



1/2

TÖNNIS-ADSON

BC273R

175 mm, 7"

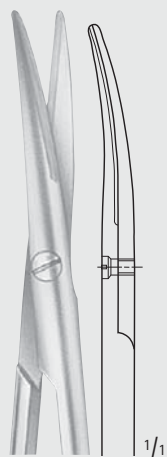

1/1



**Scheren – Scissors**  
**DUROTIP® Präparierscheren**  
**DUROTIP® Dissecting Scissors**

**BC**

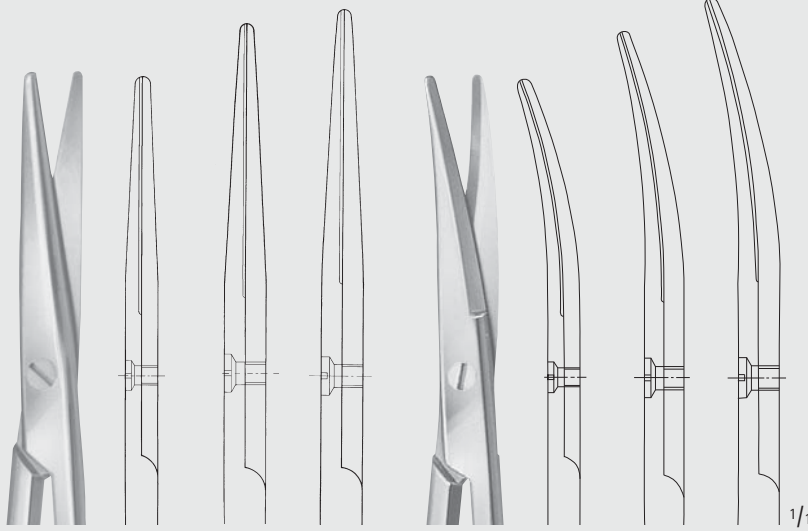
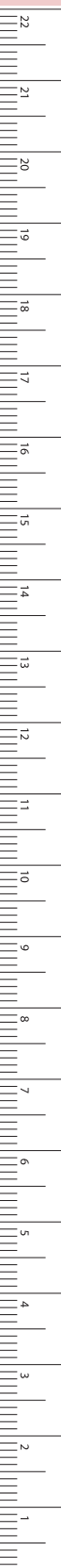

BC270R	BC274R	BC276R
180 mm	200 mm	230 mm
7"	8"	9"

BC271R	BC275R	BC277R
180 mm	200 mm	230 mm
7"	8"	9"

**METZENBAUM**

**BC270R-BC277R**



BC279R	BC281R	BC282R
260 mm	280 mm	285 mm
10 1/4"	11"	11 1/4"

**NELSON-METZENBAUM**

**BC279R-BC285R**

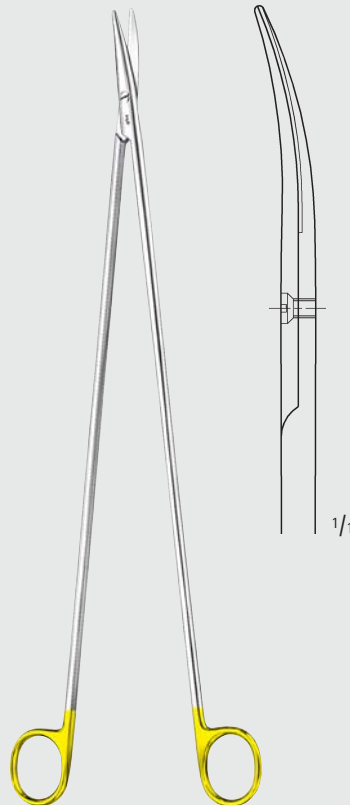

**NELSON-METZENBAUM**

**BC285R**

350 mm, 14"

MILLIMETERS

## Scheren – Scissors

DUROTIP® Präparierscheren

DUROTIP® Dissecting Scissors

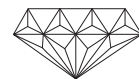

BC

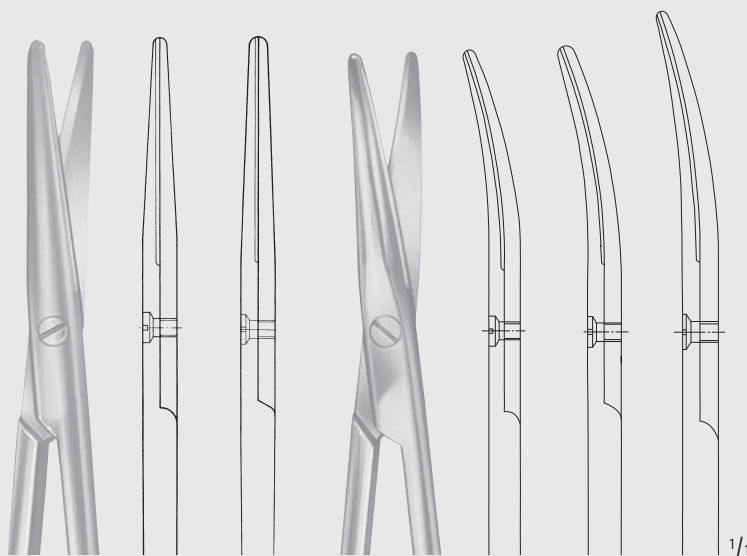

<b>BC260R</b>	<b>BC262R</b>
145 mm	180 mm
5 3/4"	7"

<b>BC261R</b>	<b>BC263R</b>	<b>BC265R</b>
145 mm	180 mm	200 mm
5 3/4"	7"	8"

METZENBAUM

BC260R-BC265R

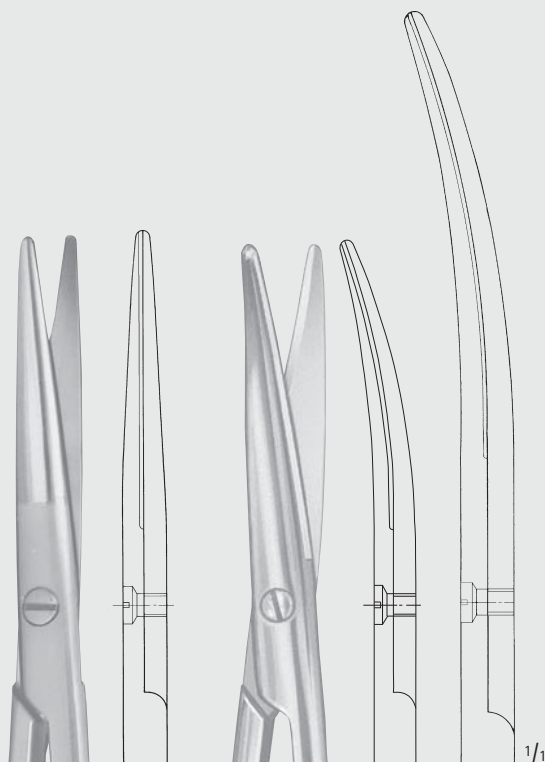

<b>BC266R</b>
200 mm
9"

<b>BC267R</b>	<b>BC289R</b>
230 mm	300 mm
9"	12"

NELSON-METZENBAUM (MC INDOE)

BC266R-BC289R



breite Blattenden  
broad blade ends

METZENBAUM

BC287R

230 mm, 9"



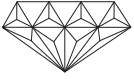

Scheren – Scissors  
 DUROTIP® Scheren  
 DUROTIP® Scissors

BC

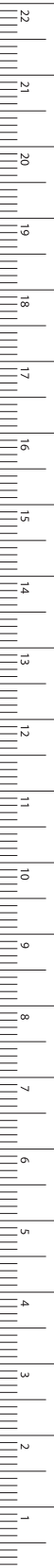

MILLIMETERS

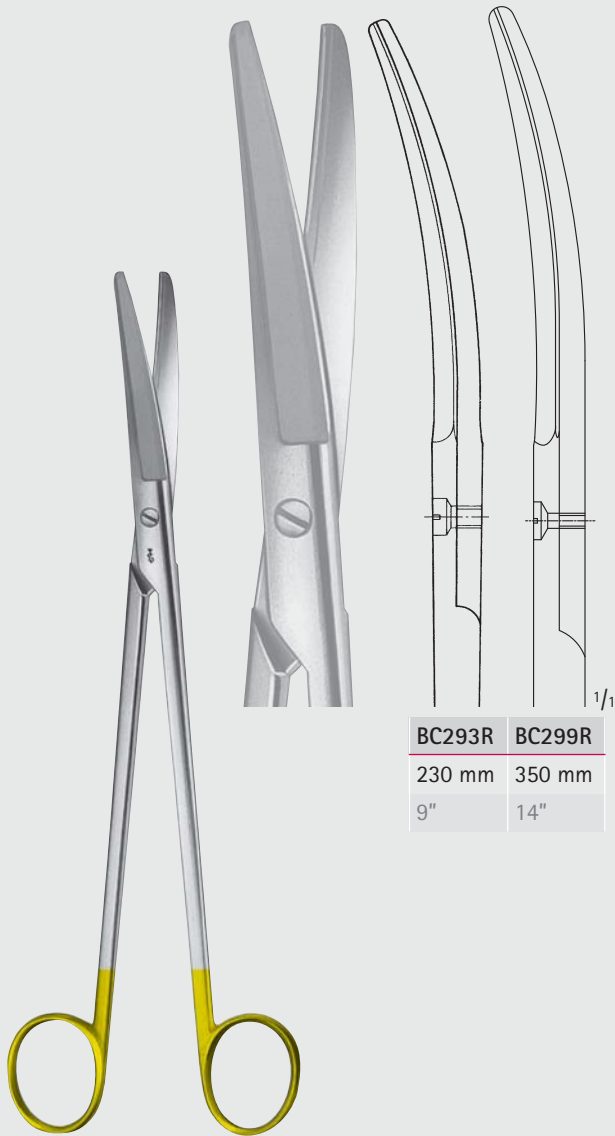

BC293R	BC299R
230 mm	350 mm
9"	14"

WERTHEIM

**BC293R-BC299R**

Präparierscheren  
 Dissecting scissors

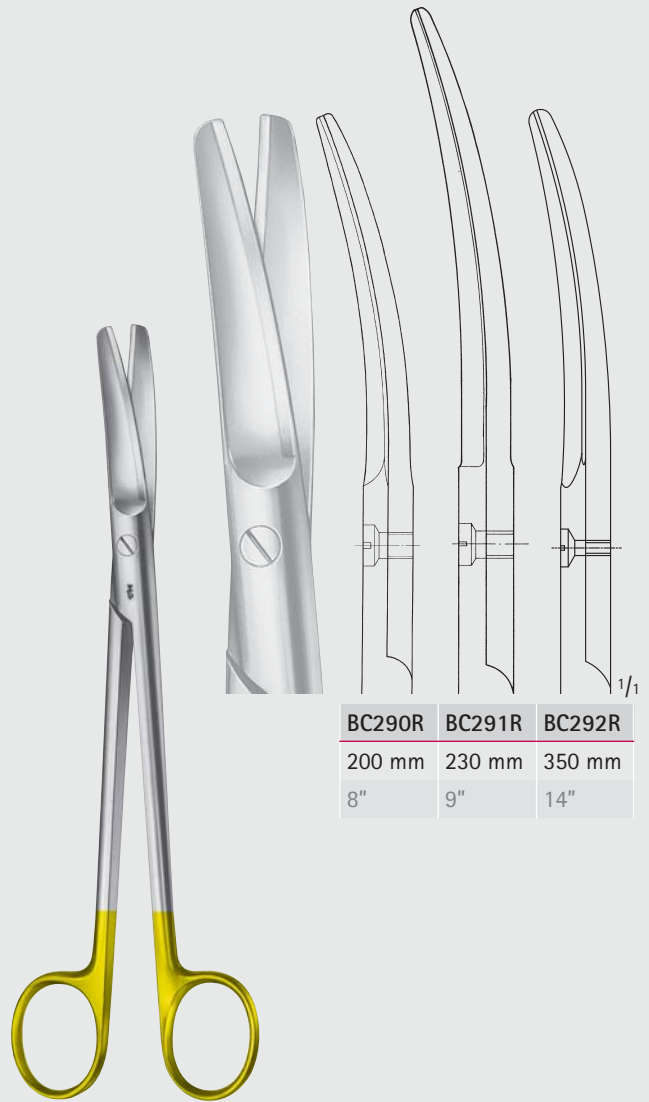

BC290R	BC291R	BC292R
200 mm	230 mm	350 mm
8"	9"	14"

SIMS

**BC290R-BC292R**

Uterusscheren  
 Uterine scissors

## Scheren – Scissors

DUROTIP® Scheren

DUROTIP® Scissors

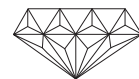

BC

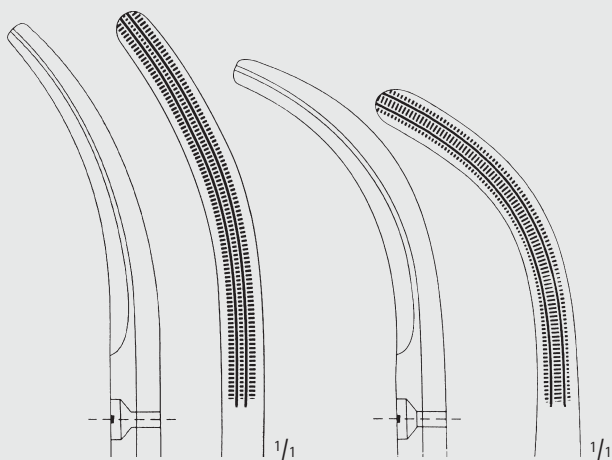

BC551R

BJ551R

BC552R

BJ552R

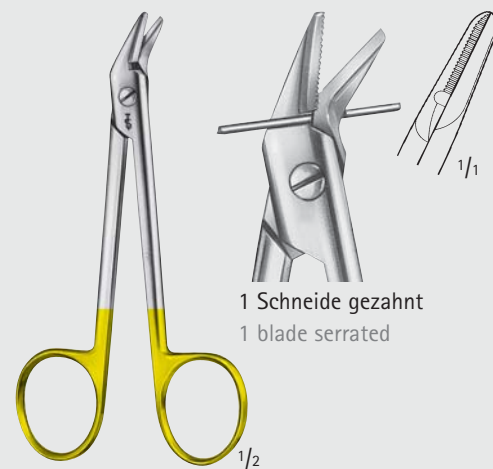

1 Schneide gezahnt  
1 blade serrated

DP552R

Draht- und Blechschere

Wire cutting scissors

120 mm, 4 3/4"



BC551R

255 mm

10"

BC552R

250 mm

10"

BC551R-BJ552R

Hysterektomiescheren, stark gebogen, passend zu den Parametriumklammern BJ551R und BJ552R.

Hysterectomy scissors, strongly curved, fitting parametrium clamps BJ551R and BJ552R.

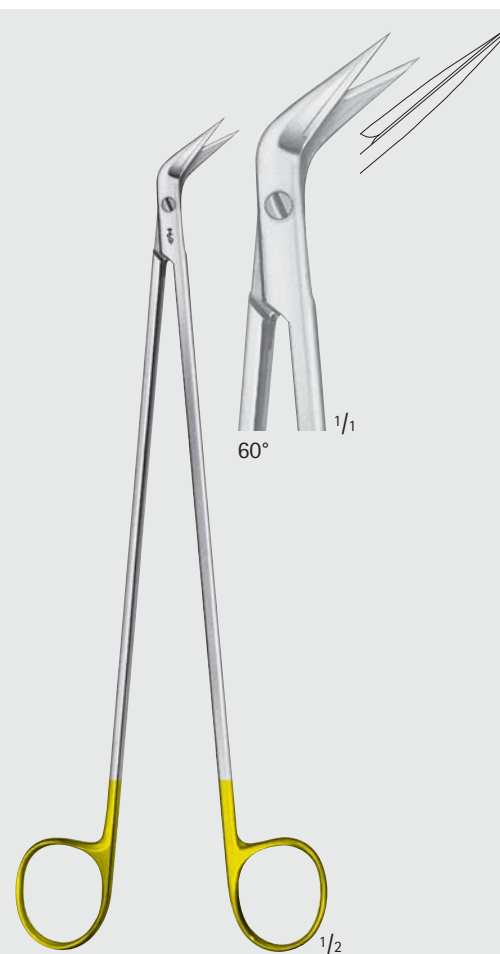

60°

DE BAKEY

BC245R

Gefäßschere

Vascular scissors

220 mm, 8 3/4"

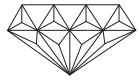

## Scheren – Scissors

DUROTIP® Scheren mit **W**ellenschliff  
DUROTIP® **W**avecut Scissors

**W**ellenschliff  
verhindert das Herausgleiten  
des Gewebes

**W**avecut  
prevents tissue  
from slipping out



Artikel mit dem Zusatz **W**  
sind auf einer Schnittfläche  
mit Wellenschliff versehen  
(bei Bestellungen bitte an-  
geben - z.B. BC211W)

**W** directly after the  
catalog number indicates  
that the resp. item has one  
serrated cutting edge.  
(When ordering please  
indicate together with the  
catalog number e.g.  
BC211W)

»grazil«

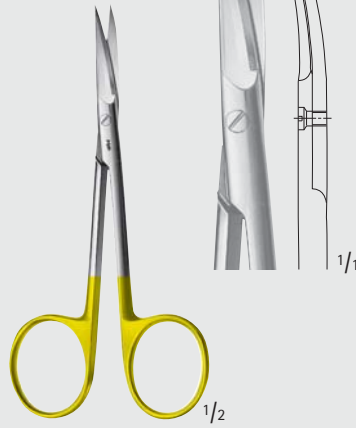

**BC211W**

Fadenschere  
Ligature scissors  
110 mm, 4 3/8"



**BC231W**

Chirurgische Schere  
Surgical Scissors  
145 mm, 5 3/4"

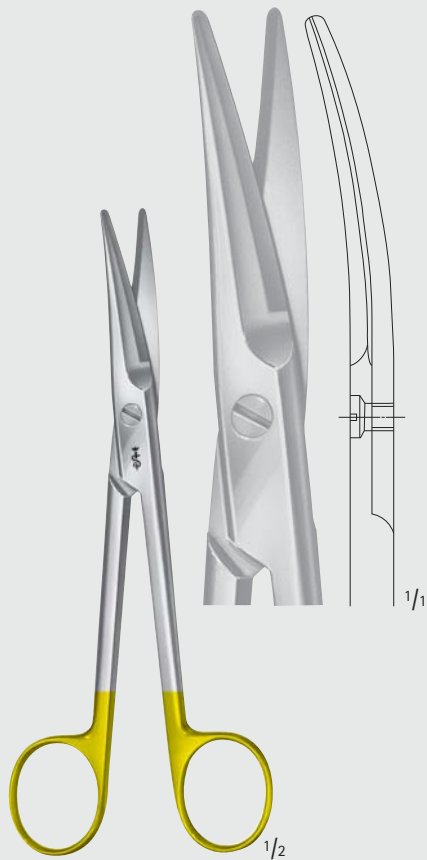

MAYO

**BC253W**

Präparierschere  
Dissecting scissors  
170 mm, 6 3/4"

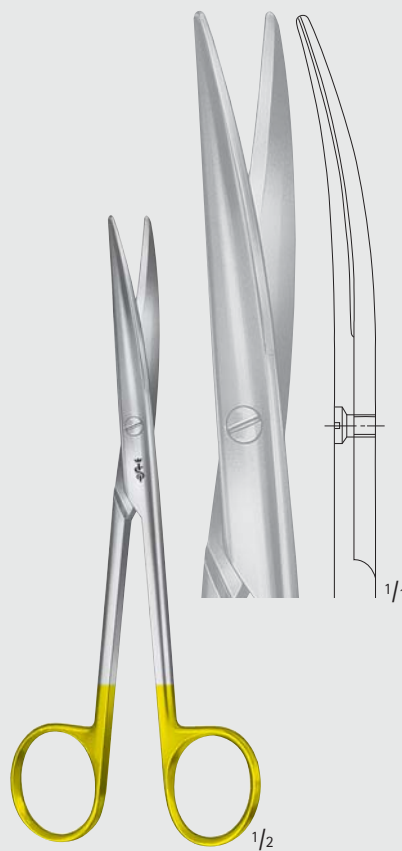

LEXER

**BC283W**

Präparierschere, schmal  
Dissecting scissors, slender  
165 mm, 6 1/2"

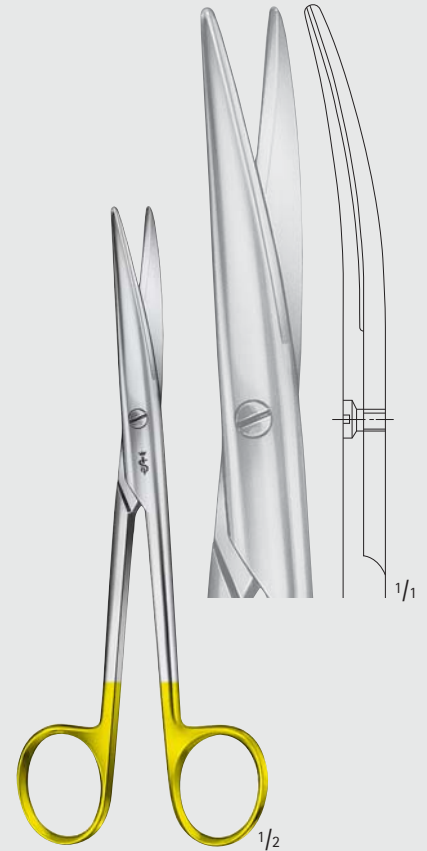

MAYO-LEXER

**BC284W**

Präparierschere  
Dissecting scissors  
165 mm, 6 1/2"

BC



MILLIMETERS

## Scheren – Scissors

DUROTIP® Präparierscheren mit **W**ellenschliff  
 DUROTIP® **W**avecut Dissecting Scissors

»grazil«

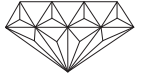

BC

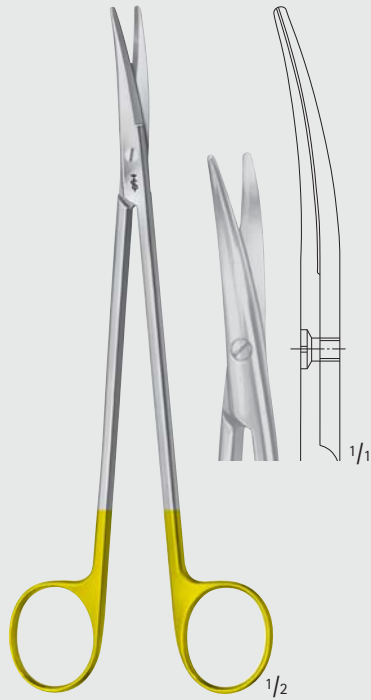

**BC257W**

115 mm, 4 1/2"

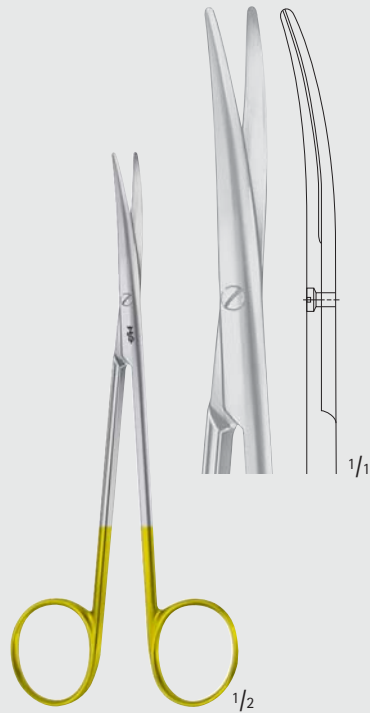

**BABY-METZENBAUM**

**BC259W**

145 mm, 5 3/4"

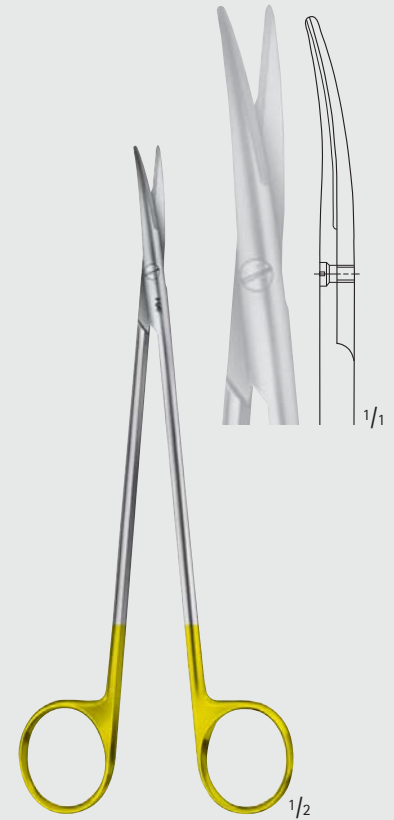

**TÖNNIS-ADSON**

**BC273W**

175 mm, 7"

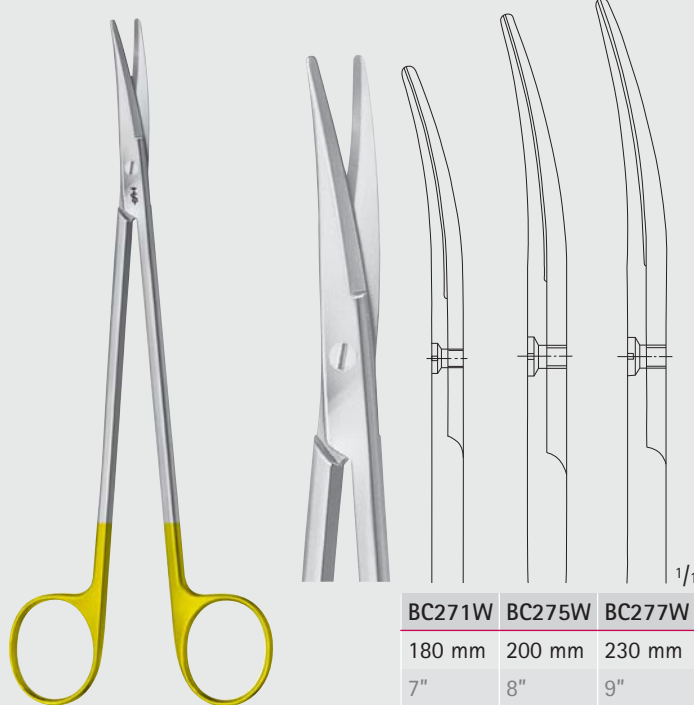

**METZENBAUM**

**BC271W-BC277W**

BC271W	BC275W	BC277W
180 mm	200 mm	230 mm
7"	8"	9"

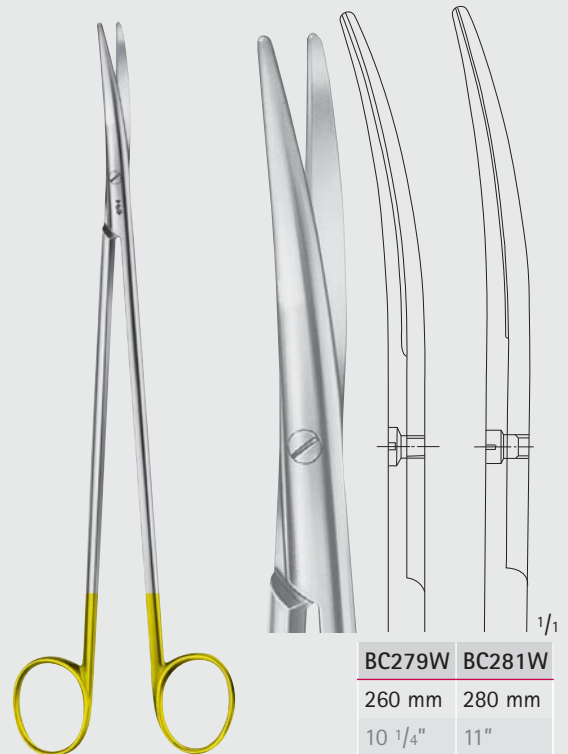

**NELSON-METZENBAUM**

**BC279W-BC281W**

BC279W	BC281W
260 mm	280 mm
10 1/4"	11"

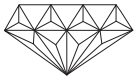

## Scheren – Scissors

DUROTIP® Präparierscheren mit Wellenschliff  
DUROTIP® Wavecut Dissecting Scissors

BC

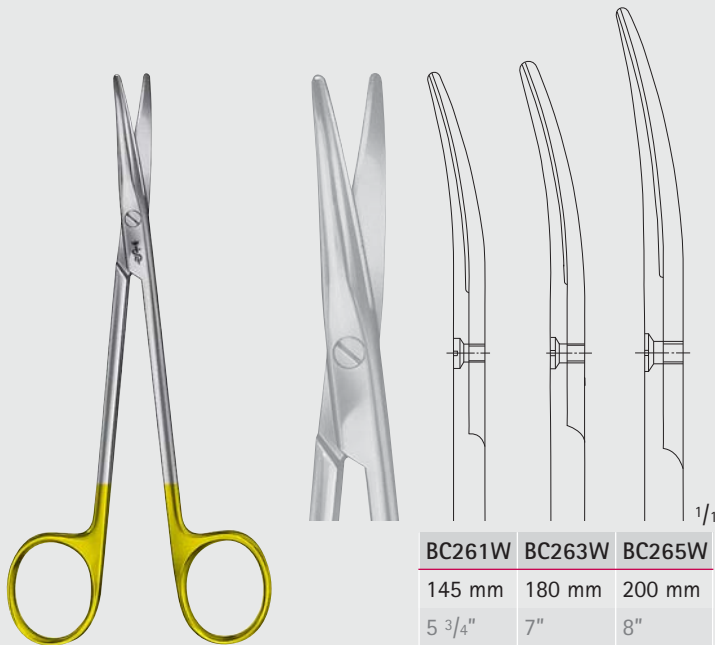

BC261W	BC263W	BC265W
145 mm	180 mm	200 mm
5 3/4"	7"	8"

METZENBAUM

BC261W-BC265W

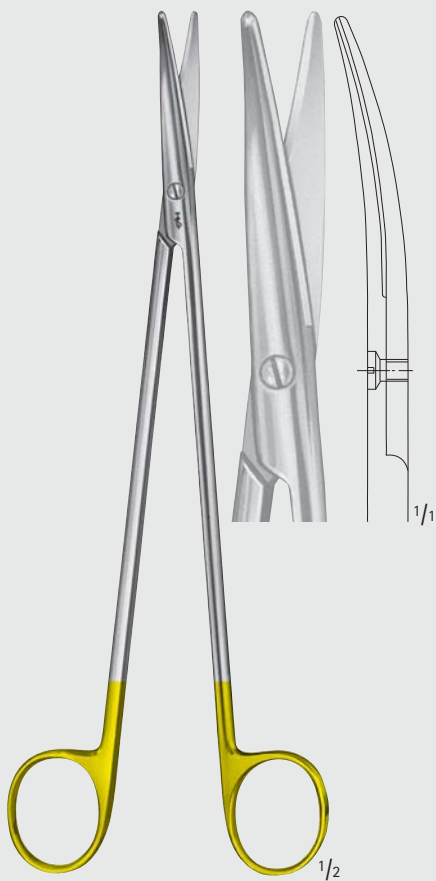

NELSON-METZENBAUM

BC267W

230 mm, 9"

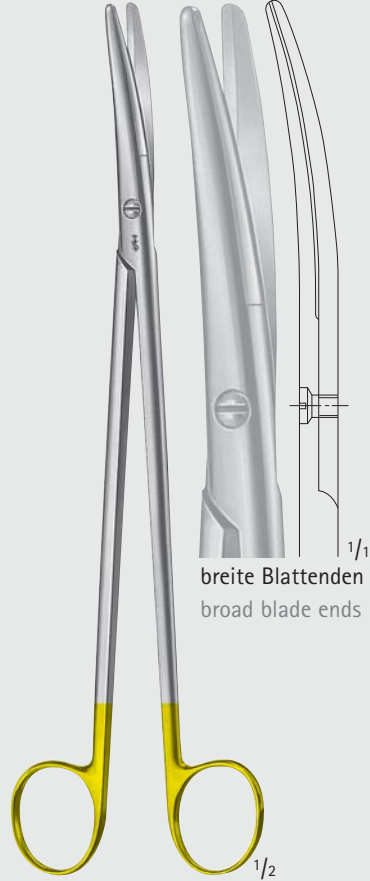

breite Blattenden  
broad blade ends

METZENBAUM

BC287W

230 mm, 9"



BC290W	BC291W
200 mm	230 mm
8"	9"

SIMS

BC290W-BC291W

Uterusscheren  
Uterine scissors



MILLIMETERS

## Scheren – Scissors

DUROTIP® Ligaturscheren mit **W**ellenschliff

DUROTIP® **W**avecut Ligature Scissors

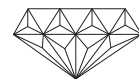

BC

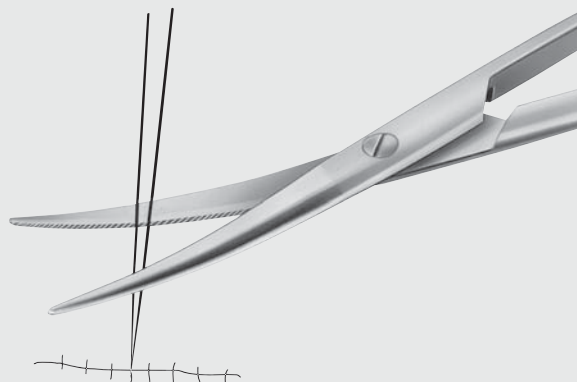

speziell zum Schneiden von Nahtmaterial

- Hartmetalleinlagen gewähren dauerhafte Schnittschärfe (auch im distalen Bereich der Scherenblätter)
- der Spezial-**W**ellenschliff verhindert das Abgleiten des Nahtmaterials
- DUROTIP®-Ligaturscheren sind gekennzeichnet mit 1 vergoldeten Ring

especially for cutting suture materials

- Carbide inserts guarantee permanent cutting edge (also in the distal area of the blades)
- **W**avecut prevents suture materials from slipping out
- DUROTIP® ligature scissors are identified by 1 goldplated ring



BC294W-BC298W

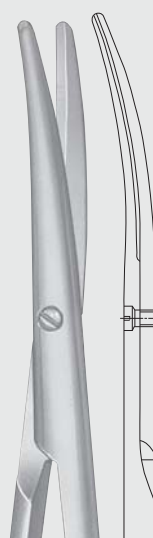

BC294W

145 mm

5 3/4"

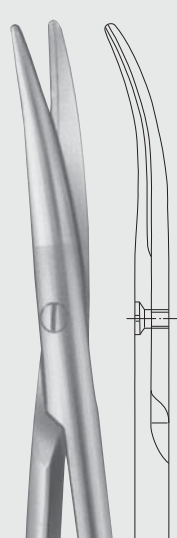

BC295W

180 mm

7"

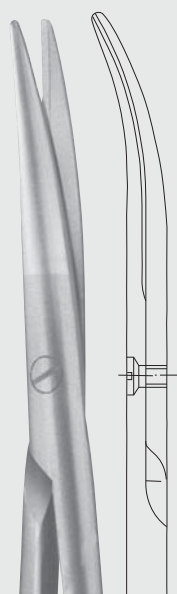

BC296W

230 mm

9"

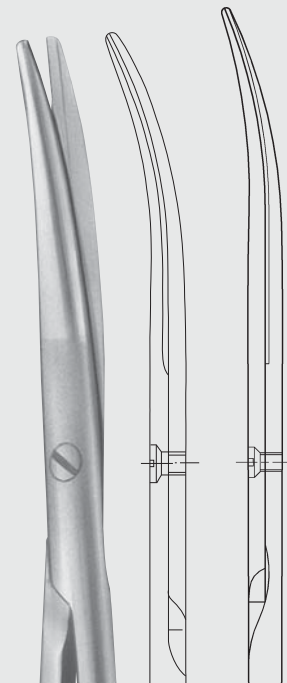

BC297W BC298W

260 mm

10 1/4"

350 mm

14"

1/1

**По вопросам продаж и поддержки обращайтесь:**

Алматы (7273)495-231	Казань (843)206-01-48	Новокузнецк (3843)20-46-81	Смоленск (4812)29-41-54
Архангельск (8182)63-90-72	Калининград (4012)72-03-81	Новосибирск (383)227-86-73	Сочи (862)225-72-31
Астрахань (8512)99-46-04	Калуга (4842)92-23-67	Омск (3812)21-46-40	Ставрополь (8652)20-65-13
Барнаул (3852)73-04-60	Кемерово (3842)65-04-62	Орел (4862)44-53-42	Сургут (3462)77-98-35
Белгород (4722)40-23-64	Киров (8332)68-02-04	Оренбург (3532)37-68-04	Тверь (4822)63-31-35
Брянск (4832)59-03-52	Краснодар (861)203-40-90	Пенза (8412)22-31-16	Томск (3822)98-41-53
Владивосток (423)249-28-31	Красноярск (391)204-63-61	Пермь (342)205-81-47	Тула (4872)74-02-29
Волгоград (844)278-03-48	Курск (4712)77-13-04	Ростов-на-Дону (863)308-18-15	Тюмень (3452)66-21-18
Вологда (8172)26-41-59	Липецк (4742)52-20-81	Рязань (4912)46-61-64	Ульяновск (8422)24-23-59
Воронеж (473)204-51-73	Магнитогорск (3519)55-03-13	Самара (846)206-03-16	Уфа (347)229-48-12
Екатеринбург (343)384-55-89	Москва (495)268-04-70	Санкт-Петербург (812)309-46-40	Хабаровск (4212)92-98-04
Иваново (4932)77-34-06	Мурманск (8152)59-64-93	Саратов (845)249-38-78	Челябинск (351)202-03-61
Ижевск (3412)26-03-58	Набережные Челны (8552)20-53-41	Севастополь (8692)22-31-93	Череповец (8202)49-02-64
Иркутск (395)279-98-46	Нижний Новгород (831)429-08-12	Симферополь (3652)67-13-56	Ярославль (4852)69-52-93
Россия (495)268-04-70	Киргизия (996)312-96-26-47	Казахстан (7172)727-132	