

# Технические характеристики

## По вопросам продаж и поддержки обращайтесь:

Алматы (7273)495-231	Казань (843)206-01-48	Новокузнецк (3843)20-46-81	Смоленск (4812)29-41-54
Архангельск (8182)63-90-72	Калининград (4012)72-03-81	Новосибирск (383)227-86-73	Сочи (862)225-72-31
Астрахань (8512)99-46-04	Калуга (4842)92-23-67	Омск (3812)21-46-40	Ставрополь (8652)20-65-13
Барнаул (3852)73-04-60	Кемерово (3842)65-04-62	Орел (4862)44-53-42	Сургут (3462)77-98-35
Белгород (4722)40-23-64	Киров (8332)68-02-04	Оренбург (3532)37-68-04	Тверь (4822)63-31-35
Брянск (4832)59-03-52	Краснодар (861)203-40-90	Пенза (8412)22-31-16	Томск (3822)98-41-53
Владивосток (423)249-28-31	Красноярск (391)204-63-61	Пермь (342)205-81-47	Тула (4872)74-02-29
Волгоград (844)278-03-48	Курск (4712)77-13-04	Ростов-на-Дону (863)308-18-15	Тюмень (3452)66-21-18
Вологда (8172)26-41-59	Липецк (4742)52-20-81	Рязань (4912)46-61-64	Ульяновск (8422)24-23-59
Воронеж (473)204-51-73	Магнитогорск (3519)55-03-13	Самара (846)206-03-16	Уфа (347)229-48-12
Екатеринбург (343)384-55-89	Москва (495)268-04-70	Санкт-Петербург (812)309-46-40	Хабаровск (4212)92-98-04
Иваново (4932)77-34-06	Мурманск (8152)59-64-93	Саратов (845)249-38-78	Челябинск (351)202-03-61
Ижевск (3412)26-03-58	Набережные Челны (8552)20-53-41	Севастополь (8692)22-31-93	Череповец (8202)49-02-64
Иркутск (395)279-98-46	Нижний Новгород (831)429-08-12	Симферополь (3652)67-13-56	Ярославль (4852)69-52-93
Россия (495)268-04-70	Киргизия (996)312-96-26-47	Казахстан (7172)727-132	



## Untersuchung - Diagnostik - Examination - Diagnostic Instrumente zum Messen Instruments for Measuring

AD



### AA804R-AA806R

Stahlmaßstab, nichtrostend,  
Millimeter- und Zolleinteilung  
Steel ruler, stainless, graduated  
in millimeters and inches

AA804R	AA805R	AA806R
150 mm	300 mm	500 mm
6"	12"	20"



### AA808R

Röntgen-Messstab für Messungen bei Frakturbehandlung.  
Direkte Ablesemöglichkeit der Abmessungen.  
Einteilung in 1/2 cm durch gut sichtbare Kerben an  
der Kante, die vollen cm sind durch tiefe Kerben  
ersichtlich. Um das Ablesen zu erleichtern, sind  
die 5 cm und 10 cm Abstände durch Löcher markiert.  
Ruler for X-ray work in fracture treatment.  
Direct reading. Graduation from half to half cm by  
distinct notches at the rim. Full cms are accentuated  
by deeper notches. Markings of 5 cm and decimeter  
distance by one and two holes respectively.  
500 mm, 20"

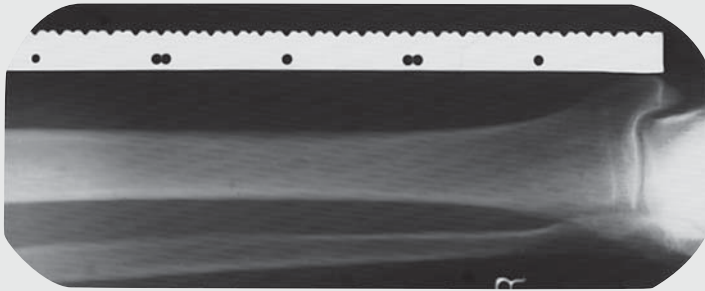

MILLIMETERS

## Untersuchung – Diagnostik – Examination – Diagnostic

Instrumente zum Messen

Instruments for Measuring

AD



AA845R

Spezial-Messschieber  
für die Neurochirurgie

Special caliper  
for neurosurgery  
125 mm, 5"



AA846R

Messschieber,  
Messbereich bis 150 mm

Caliper,  
measuring range up to 150 mm  
230 mm, 9"



AA847R

Messschieber,  
Messbereich bis 100 mm

Caliper,  
measuring range up to 100 mm  
130 mm, 5 1/8"

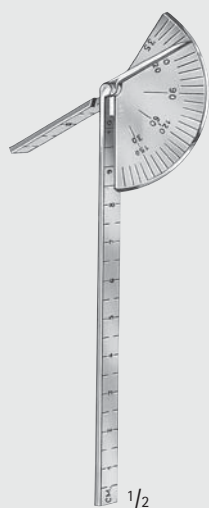

AD110R

Finger-Goniometer  
Finger goniometer

INCHES

# Geburtshilfe – Obstetrics

Beckenzirkel

Pelvimeters



DE LEE

ET005R

Beckenzirkel mit Zentimeter- und Zolleinteilung für innere Messungen zwischen Symphyse und Promontorium

Pelvimeter graduated in centimeters and inches for interior measurements between symphysis and promontory

1/2



MARTIN

ET073R

mit Zentimereinteilung graduated in centimeters

1/3



SCHMELZ

ET002

Rechenscheibe

Gestation calculator

1/3

ET



INCHES

# Valve XS

Miscellaneous



FC357R

## Tendinous Cords Ruler

Total length 14" (355 mm)  
Working length 10" (250 mm)  
Measuring range 5-40 mm

## Patient Preparation – Patienten-Vorbereitung

Steel Ruler, Calipers

Stahlmaßstab, Messzirkel, Messschieber

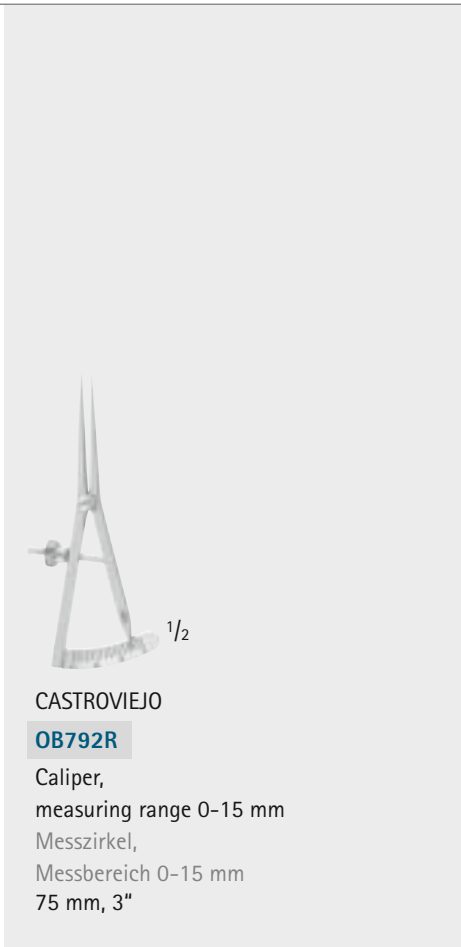

CASTROVIEJO

**OB792R**

Caliper,  
measuring range 0-15 mm

Messzirkel,  
Messbereich 0-15 mm  
75 mm, 3"

Preparation  
Vorbereitung

INCHES

# Otology, Micro Ear Surgery – Otologie, Mikro-Ohrchirurgie

Measuring Instruments, Preparation Tray, Vein Graft Press Forceps

Messinstrumente, Präpariertablett, Implantate Presszange



**OG140R**

Measuring instrument,  
marker pins at 3.5 - 4.0 - 4.5 mm  
Messinstrument,  
Markierungen bei 3,5 - 4,0 - 4,5 mm  
160 mm, 6 1/4"



**OG141R**

Measuring instrument  
Messinstrument  
165 mm, 6 1/2"



**OG145R** 92 x 54 mm

Preparation tray,  
with mm scale, stainless steel  
Präpariertablett aus Metall,  
mit mm-Skala

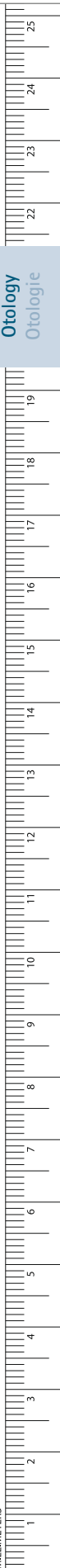

# ENT-ORAL

## Laryngeal Mirrors



OM078R-OM090R



OM078R



OM079R



OM080R



OM081R



OM082R



OM083R



OM084R



OM085R



OM086R



OM087R



OM088R



OM089R



OM090R

### Laryngeal Mirror, Rigid, W/ Hex Handle

Catalog Number	Size (#)	Diameter (mm)	Length (in.)
OM078R	000	6.0	7
OM079R	00	8.0	7
OM080R	0	10.0	7
OM081R	1	12.0	7
OM082R	2	14.0	7
OM083R	3	16.0	7
OM084R	4	18.0	7
OM085R	5	20.0	7
OM086R	6	22.0	7
OM087R	7	24.0	7
OM088R	8	26.0	7
OM089R	9	28.0	7
OM090R	10	30.0	7



AC468R-AC480R



AC468R



AC469R



AC470R

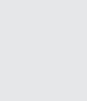

AC471R

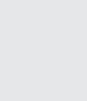

AC472R



AC473R



AC474R



AC475R



AC476R



AC477R



AC478R



AC479R



AC480R

### Laryngeal Mirror, Rigid, F/ Handle AC481R

Catalog Number	Size (#)	Diameter (mm)	Length (in.)
AC468R	000	6.0	4 3/4
AC469R	00	8.0	4 3/4
AC470R	0	10.0	4 3/4
AC471R	1	12.0	4 3/4
AC472R	2	15.0	4 3/4
AC473R	3	16.0	4 3/4
AC474R	4	18.0	4 3/4
AC475R	5	20.0	4 3/4
AC476R	6	22.0	4 3/4
AC477R	7	24.0	4 3/4
AC478R	8	26.0	4 3/4
AC479R	9	28.0	4 3/4
AC480R	10	30.0	4 3/4
AC481R	-	HANDLE	4 1/4

ENT  
ORAL

MILLIMETERS



# Untersuchung – Diagnostik – Examination – Diagnostic

## Narkoseinstrumente

### Instruments for Anaesthesia

Zungenspatel siehe Rubrik AC  
Tongue depressors see section AC



HEISTER

OM030R

Mundsperrer

Mouth gag

130 mm, 5 1/8"



FERGUSSON-ACKLAND

OM044R

Mundsperrer

Mouth gag

145 mm, 5 3/4"



Untersuchung - Diagnostik - Examination - Diagnostic  
Narkoseinstrumente  
Instruments for Anaesthesia

AN



1/2

**OM047R**

Mundsperrer  
Mouth Gag  
125 mm, 5"



1/2

**OM048R**

Mundsperrer  
Mouth gag

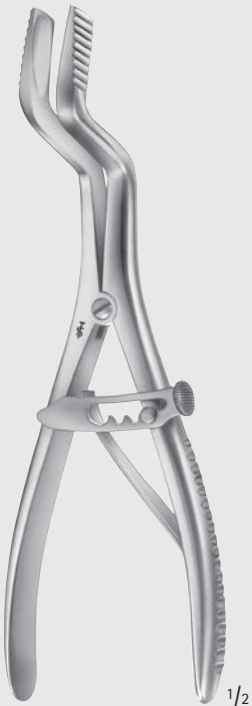

1/2

**ROSER-KÖNIG**

**OM049R**

Mundsperrer  
Mouth gag  
185 mm, 7 1/4"



1/2

**MAGILL**

**AN379R-AN381R**

Kathetereinführungszangen  
Catheter introducing forceps



**AN379R**

für Kleinkinder  
for infants  
150 mm  
6"



**AN380R**

für Kinder  
for children  
200 mm  
8"



1/1

**AN381R**

für Erwachsene  
for adults  
250 mm  
10"



MILLIMETERS

# ENT-EAR Tuning Forks



OF001N-OF006N

## HARTMANN Tuning Fork

Catalog Number	Frequency
MB575A	c 64
OF001N	c 128
OF002N	c1 256
OF003N	c2 512
OF004N	c3 1024
OF005N	c4 2048
OF006N	c5 4096



MB575A

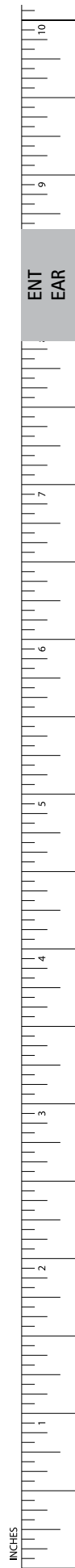

INCHES



Untersuchung - Diagnostik - Examination - Diagnostic  
 Vorbereitung  
 Preparation

AN

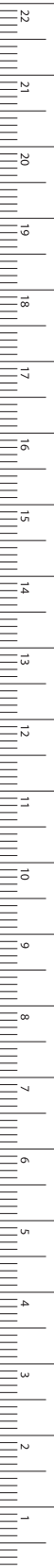

MILLIMETERS



PEAN

**BH410R**

Schlauchklemme  
 Tubing clamp forceps  
 125 mm, 5"



KLINIKUM BERLIN

**AN908R**

Schlauchklemme  
 starkes Modell, lange Sperre,  
 daher Durchlauf dosierbar  
 Tubing clamp  
 heavy pattern, long ratchet,  
 therefore passage adjustable  
 145 mm, 5 3/4"



glattes Maul  
 smooth jaw

**AN909R**

Schlauchklemme  
 sehr starkes Modell  
 Tubing clamp forceps  
 especially heavy pattern  
 165 mm, 6 1/2"



geriefes Maul  
 serrated jaw

**AN910R**

Schlauchklemme  
 sehr starkes Modell  
 Tubing clamp forceps  
 especially heavy pattern  
 165 mm, 6 1/2"

**Untersuchung – Diagnostik – Examination – Diagnostic**  
 Vorbereitung  
 Preparation

AN



**AN911R**

Schlauchklemme  
 Tubing clamp  
 180 mm, 7"



**AN912R**

Schlauchklemme  
 Tubing clamp  
 180 mm, 7"



**AN913R**

Schlauchklemme  
 Tubing clamp  
 200 mm, 8"



MD452R	MD453R	MD454R
155 mm	185 mm	200 mm
6"	7 1/4"	8"

**MD452R-MD454R**

Schlauchklemmen  
 Tubing clamps



# Korn- und Tupferzangen – Sponge- and Dressing Forceps

Korn- und Tupferzangen  
Sponge- and Dressing Forceps

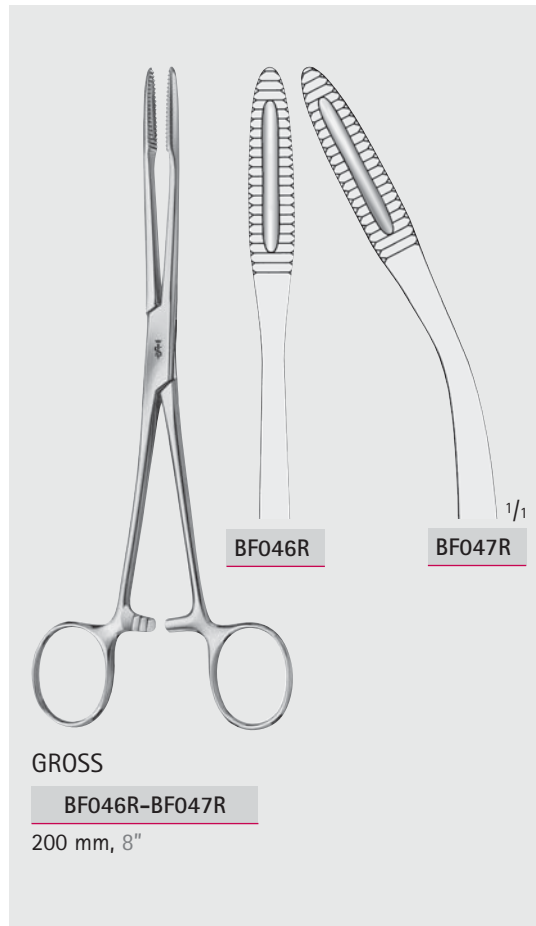
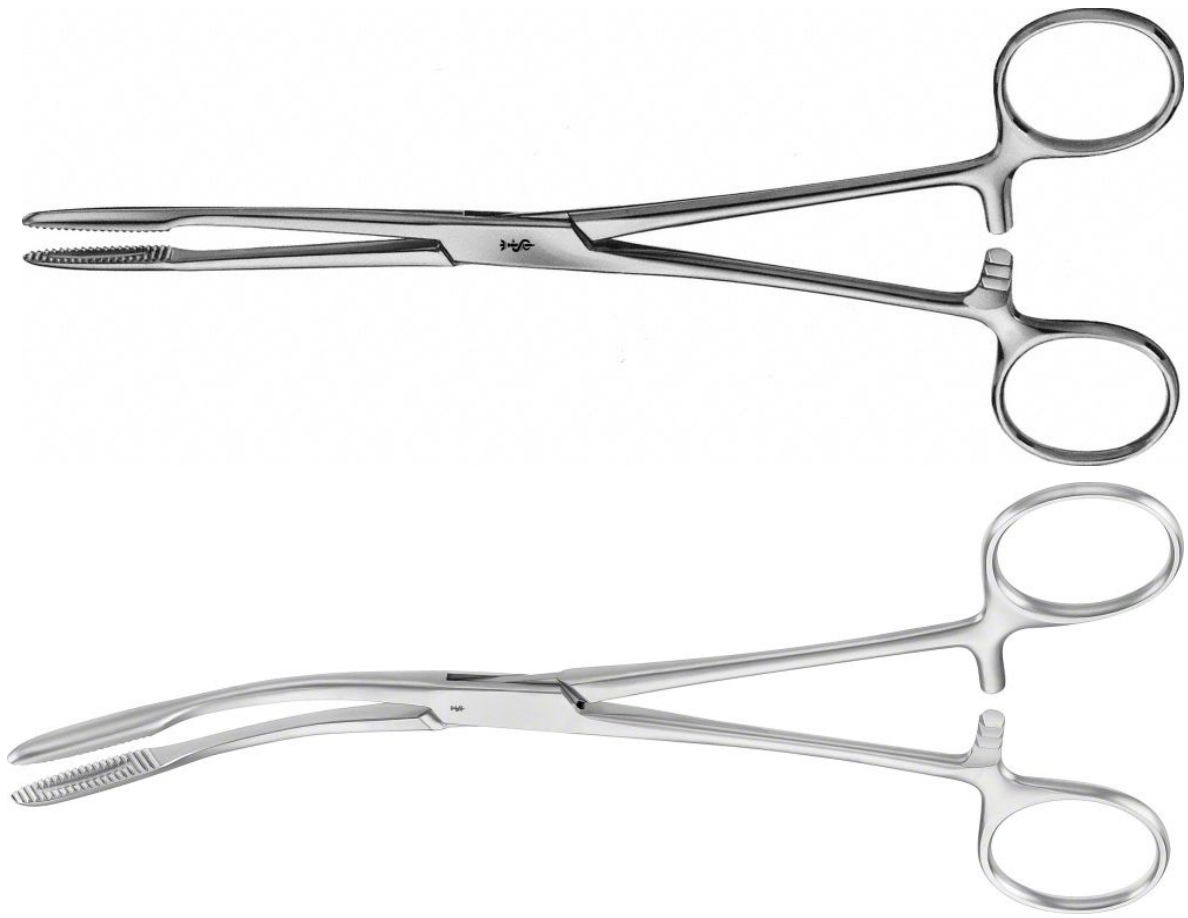

**BF**

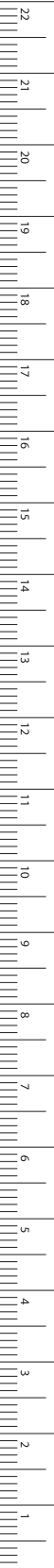

MILLIMETERS

## Korn- und Tupferzangen – Sponge- and Dressing Forceps

Korn-, Tupfer- und Waschzangen

Sponge- and Dressing Forceps

BF



BF060R

1/2



BF061R

1/1

AESCULAP

BF060R-BF061R

220 mm, 8 3/4"

# Plastic Surgery

## Aluminum Hand

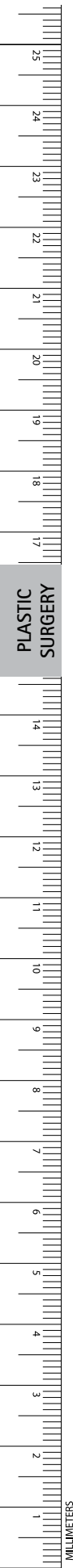

27.5 cm

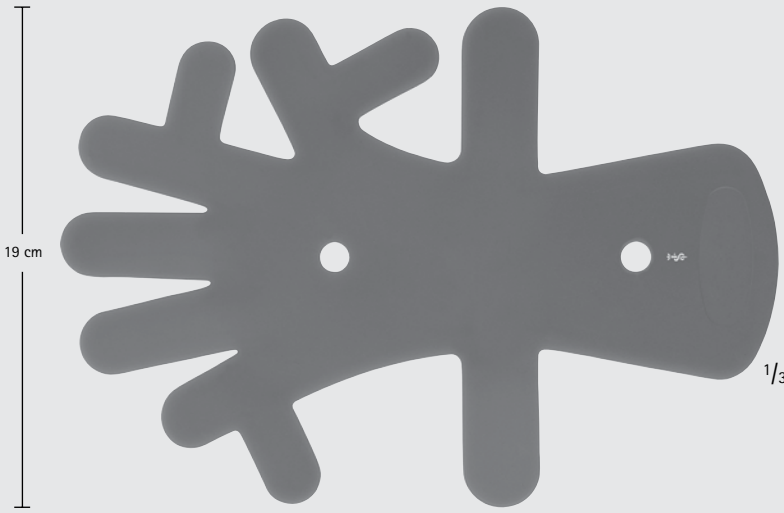

F0917A

### Aluminum Hand, Blue Silicone Coated

Catalog Number	Size (in.)
F0917A	10 3/4 x 7 1/2
F0918A	16 1/8 x 11

41 cm

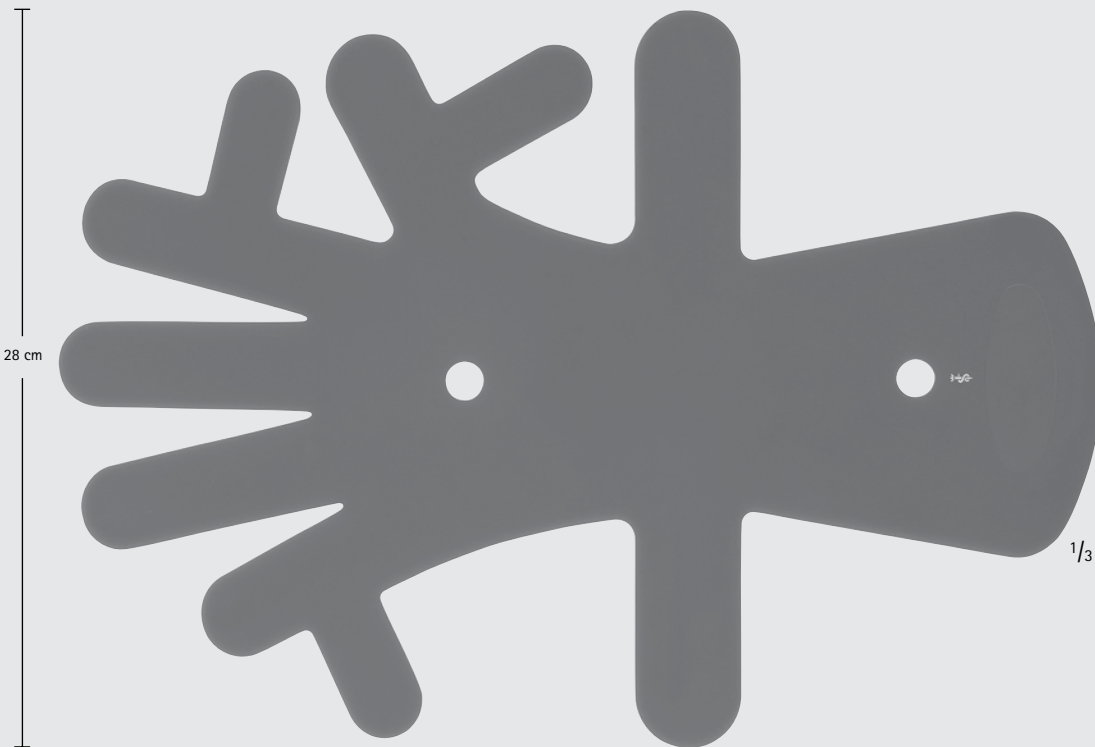

F0918A





SAUERBRUCH

JG850R

Fasszange für verbrauchtes  
Verbandmaterial und Tupfer

Operating Room

Pick-up forceps for used  
tampons and dressings

550 mm, 22"



# General Surgery

## Towel and Tubing Clamps

GENERAL SURGERY

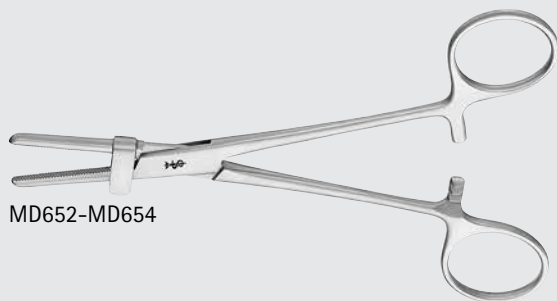

MD652-MD654



MD652



MD653



MD654

### Tubing Clamp, W/ Guard

Catalog Number	Jaw	Length (in.)
MD652	SERR	6
MD653	SERR	7
MD654	SERR	7 7/8

INCHES

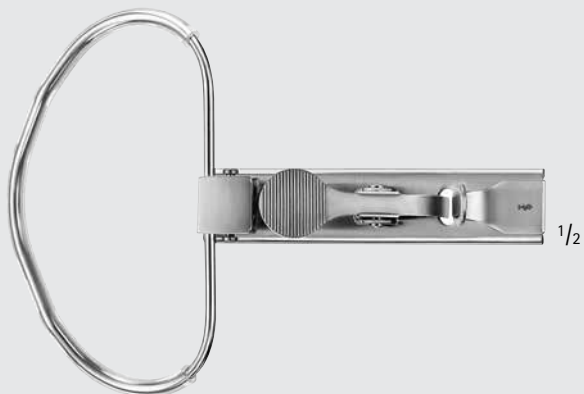

MA311R



MA312R-MA314R

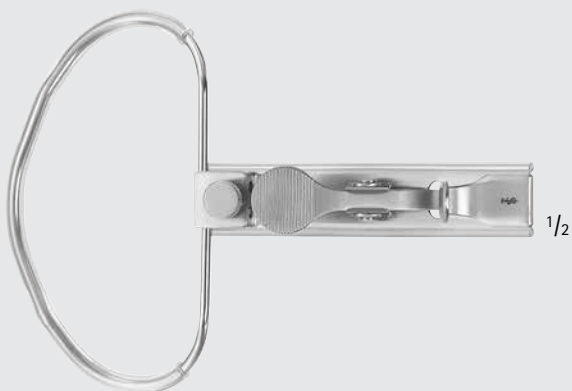

OM104R

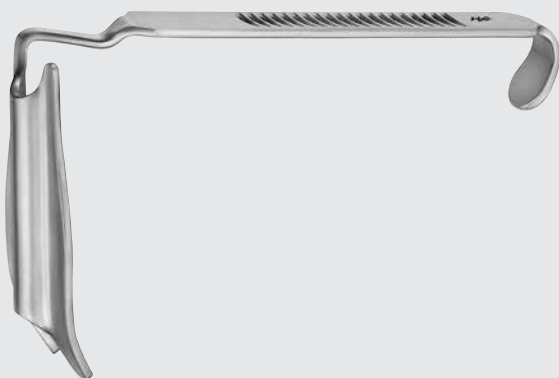

MB595R-MB600R

MCIVOR Mouth Gag

Catalog Number	Blade Size (mm)	Size (#)	Description	Length (in.)
MA311R	-	-	COMPLETE WITH FRAME AND 3 TONGUE BLADES	-
MA312R	22 x 69	1	BLADE	5 3/8
MA313R	24 x 90	2	BLADE	5 3/8
MA314R	25 x 100	3	BLADE	5 3/8
OM104R	-	-	FRAME F/ TONGUE DEPRESSOR	5 1/2
OM104201	-	-	REPLACEMENT TUBE F/ OM104R	-
OM101R	25 x 55	-	BLADE	-
OM102R	25 x 62	-	BLADE	-
OM103R	25 x 75	-	BLADE	-
MB595R	57 x 23	2	BLADE, RIGHT	-
MB596R	72 x 27	3	BLADE, RIGHT	-
MB597R	88 x 33	4	BLADE, RIGHT	-
MB598R	57 x 23	2	BLADE, LEFT	-
MB599R	72 x 27	3	BLADE, LEFT	-
MB600R	88 x 33	4	BLADE, LEFT	-
MA301R	97 x 36	5	BLADE, LEFT	-
MA300R	97 x 36	5	BLADE, RIGHT	-



OM101R-OM103R



MA300R-MA301R

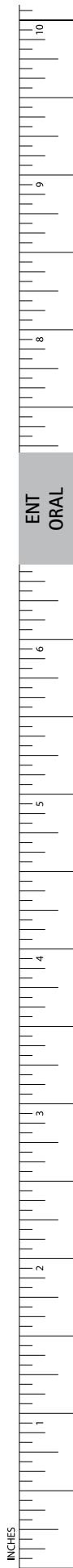

## Adenoidectomy, Tonsillectomy – Adenotomie, Tonsillektomie

Tongue Blades

Zungenspatel



## DAVIS-BOYLE

Art. No. Art. Nr.	Blade size (mm) Blattgröße (mm)	Description Beschreibung
OM111R	19 x 25	without anesthesia channel ohne Insufflationsrohr
OM112R	25 x 62	with anesthesia channel mit Insufflationsrohr
OM113R	25 x 75	with anesthesia channel mit Insufflationsrohr
OM114R	25 x 92	with anesthesia channel mit Insufflationsrohr
OM115R	25 x 108	with anesthesia channel mit Insufflationsrohr

only, suitable for OM104R, OM105R, OM116R,  
OM118R, OM119R, OM169R  
allein, passend für OM104R, OM105R, OM116R,  
OM118R, OM119R, OM169R

## Adenoidectomy, Tonsillectomy – Adenotomie, Tonsillektomie

Tongue Blades

Zungenspatel



OM150R



OM151R



OM152R



OM153R



Art. No. Art. Nr.	Blade size (mm) Blattgröße (mm)
OM150R	65
OM151R	75
OM152R	90
OM153R	102

plain for use with OM116R, OM118R, OM119R  
DAVIS-BOYLE frames  
allein, passend zu OM116R, OM118R, OM119R  
DAVIS-BOYLE Bügeln

Adenotomie  
Adenotomie

MILLIMETERS

# ENT-ORAL

## Mouth Gags



OM171R-OM178R

### RUSSEL-DAVIS Tongue Blade

Catalog Number	Blade Size (mm)
OM171R	29 x 67
OM172R	33 x 75
OM173R	38 x 85
OM174R	40 x 92
OM175R	46 x 100
OM176R	18 x 57
OM177R	22 x 67
OM178R	25 x 75



OM171R



OM172R



OM173R



OM174R



OM175R



OM176R



OM177R



OM178R

ENT  
ORAL

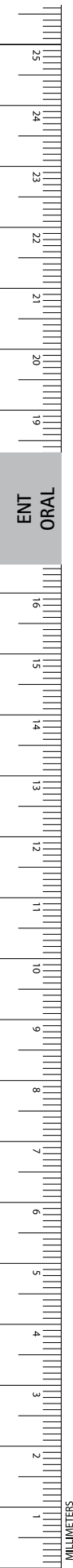

MILLIMETERS

# ENT-ORAL

## Mouth Gags

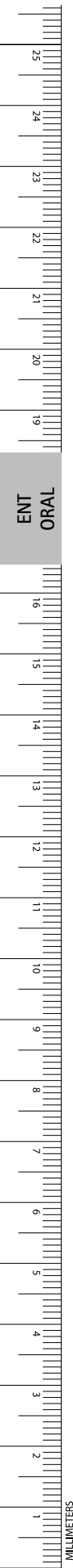

OM169R

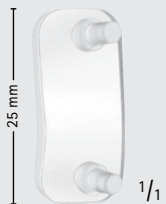

OM170



OM179R

### DAVIS-MEYER Tongue Depressor Frame

Catalog Number	Description
OM169R	FRAME, COMPLETE
OM170	SILICONE INSERT
OM179R	PALATE BLADE

**ENT-ORAL**  
Mouth Gags

**GAST Tongue Blade**

Catalog Number	Blade Size (mm)
OM181R	28 x 64
OM182R	34 x 74
OM183R	38 x 87



OM181R-OM183R



OM181R

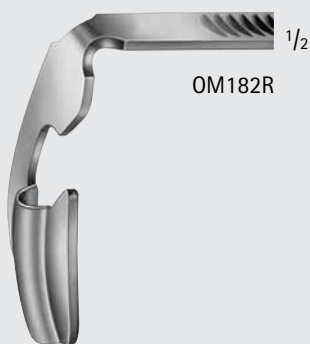

OM182R



OM183R

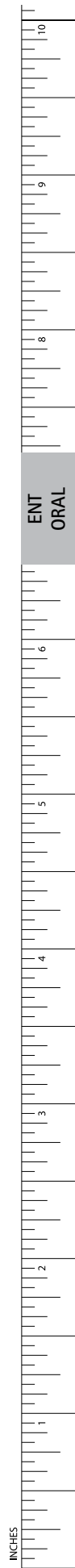

INCHES



# Untersuchung - Diagnostik - Examination - Diagnostic

Zungenspatel

Tongue Depressors

AC



OM202R

145 mm, 5 3/4"



OM203R

140 mm, 5 1/2"



BUCHWALD

OM205R

180 mm, 7"



BRUENINGS

OM208R

190 mm, 7 1/2"

# Adenoidectomy, Tonsillectomy – Adenotomie, Tonsillektomie

Tongue Depressors, Tongue Forceps

Zungenspatel, Zungenzange



LACK

Art. No.	Width (mm)
Art. Nr.	Breite (mm)

<b>OM220R</b>	13.0
---------------	------

<b>OM221R</b>	19.0
---------------	------

<b>OM222R</b>	22.0
---------------	------

curved  
gebogen

# ENT-ORAL

## Retractors

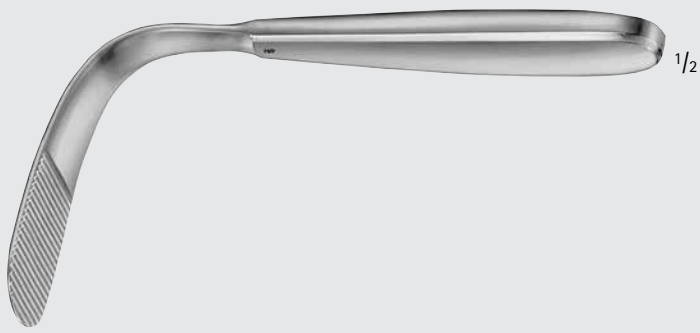

OM235R

### TOBOLD Tongue Depressor

Catalog Number	Length (in.)
OM235R	6 1/4



OM236R-OM237R

### WEDER Tongue Depressor

Catalog Number	Size	Length (in.)
OM236R	SMALL	5
OM237R	LARGE	5

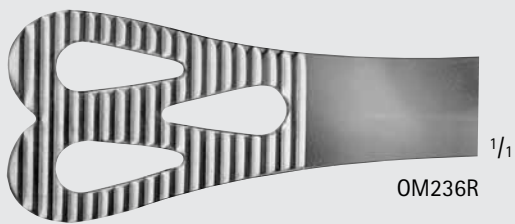

OM236R

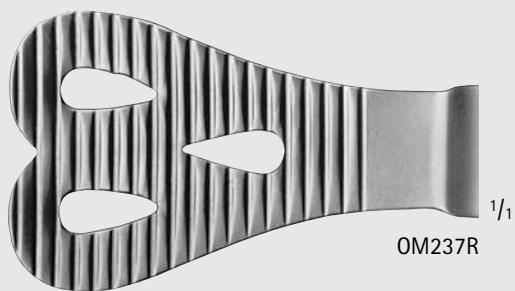

OM237R

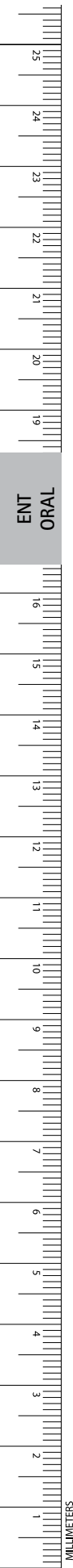

# FESS, Rhinology, Rhinoplasty – FESS, Rhinologie, Septum- und Nasenplastik

## Septum Straightening Forceps

### Septumzangen



Rhinology  
Rhinologie

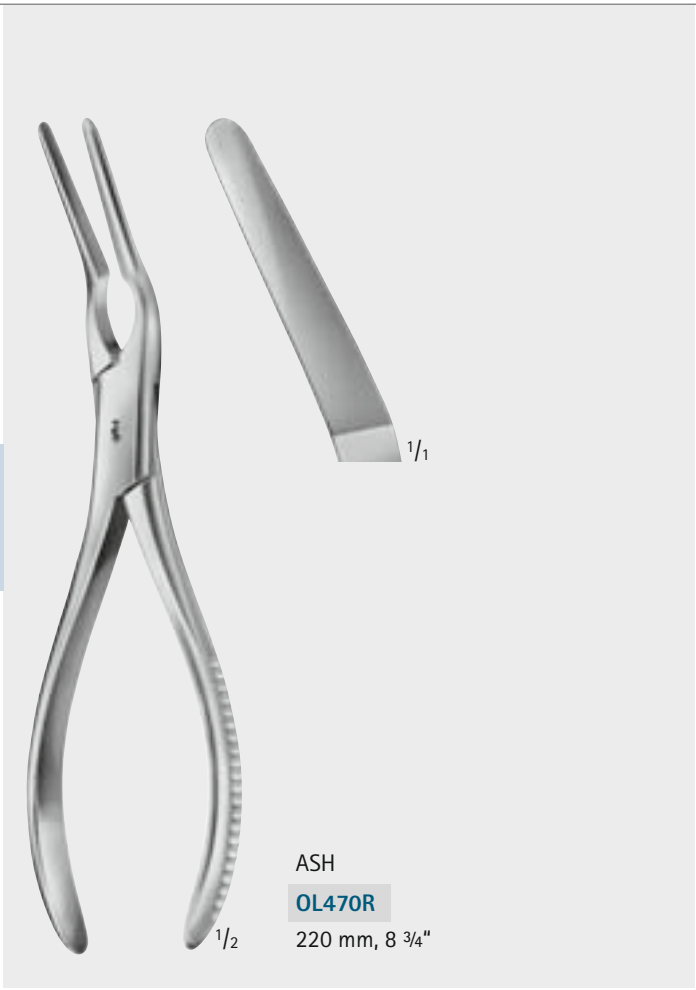

ASH  
**OL470R**  
220 mm, 8 3/4"

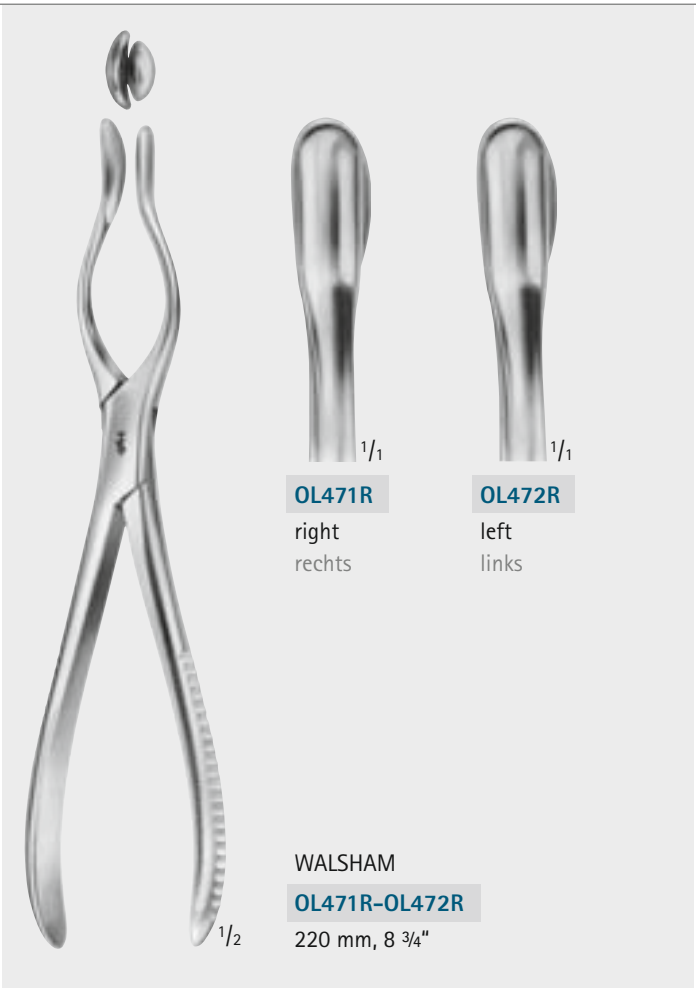

**OL471R**  
right  
rechts

**OL472R**  
left  
links

WALSHAM  
**OL471R-OL472R**  
220 mm, 8 3/4"



COTTLE-WALSHAM  
**OL473R**  
with aseptic lock  
mit aseptischem Schluss  
220 mm, 8 3/4"

# Clips, Clamps – Clips, Klemmen

## Organ and Tissue Grasping Forceps

### Organ- und Gewebefasszangen

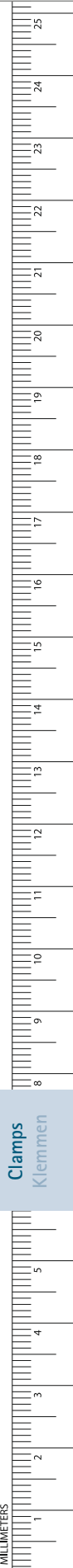
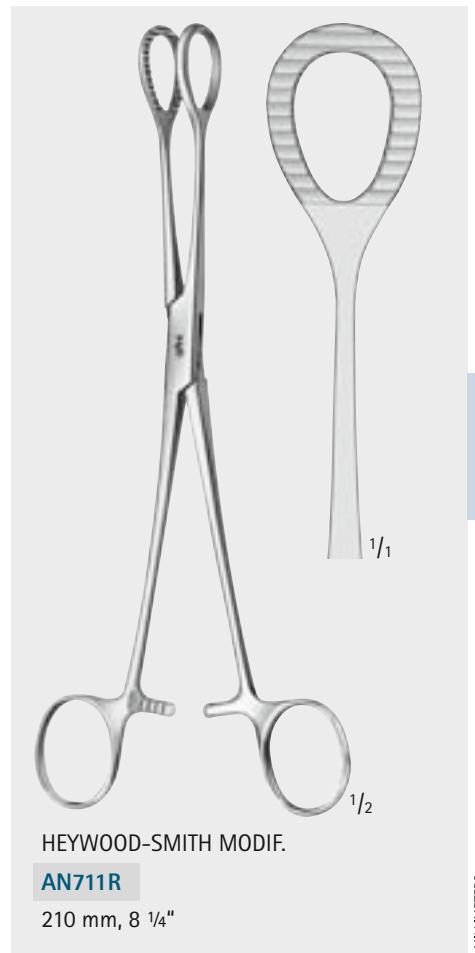
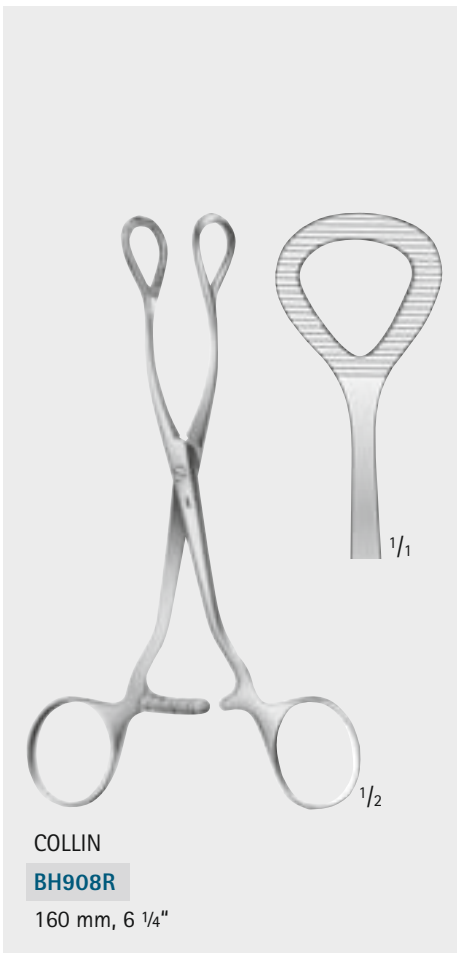
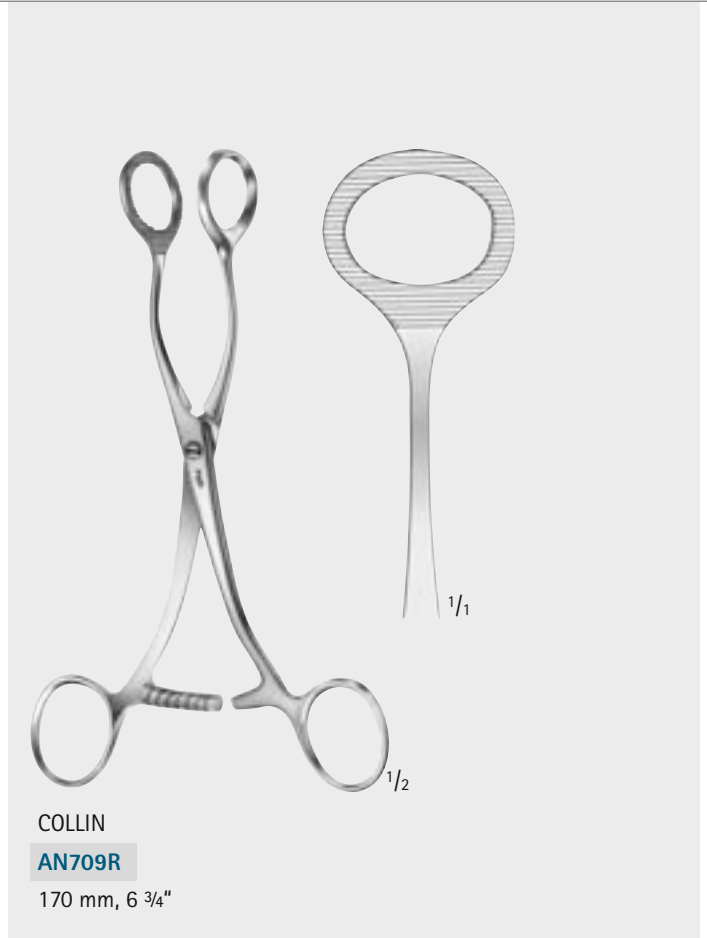
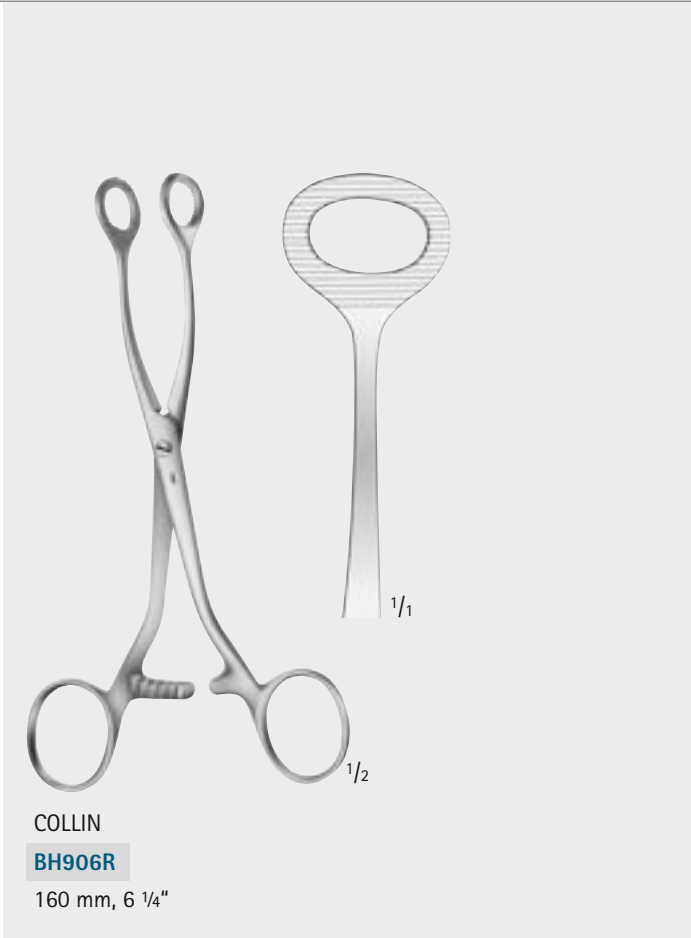

**По вопросам продаж и поддержки обращайтесь:**

Алматы (7273)495-231	Казань (843)206-01-48	Новокузнецк (3843)20-46-81	Смоленск (4812)29-41-54
Архангельск (8182)63-90-72	Калининград (4012)72-03-81	Новосибирск (383)227-86-73	Сочи (862)225-72-31
Астрахань (8512)99-46-04	Калуга (4842)92-23-67	Омск (3812)21-46-40	Ставрополь (8652)20-65-13
Барнаул (3852)73-04-60	Кемерово (3842)65-04-62	Орел (4862)44-53-42	Сургут (3462)77-98-35
Белгород (4722)40-23-64	Киров (8332)68-02-04	Оренбург (3532)37-68-04	Тверь (4822)63-31-35
Брянск (4832)59-03-52	Краснодар (861)203-40-90	Пенза (8412)22-31-16	Томск (3822)98-41-53
Владивосток (423)249-28-31	Красноярск (391)204-63-61	Пермь (342)205-81-47	Тула (4872)74-02-29
Волгоград (844)278-03-48	Курск (4712)77-13-04	Ростов-на-Дону (863)308-18-15	Тюмень (3452)66-21-18
Вологда (8172)26-41-59	Липецк (4742)52-20-81	Рязань (4912)46-61-64	Ульяновск (8422)24-23-59
Воронеж (473)204-51-73	Магнитогорск (3519)55-03-13	Самара (846)206-03-16	Уфа (347)229-48-12
Екатеринбург (343)384-55-89	Москва (495)268-04-70	Санкт-Петербург (812)309-46-40	Хабаровск (4212)92-98-04
Иваново (4932)77-34-06	Мурманск (8152)59-64-93	Саратов (845)249-38-78	Челябинск (351)202-03-61
Ижевск (3412)26-03-58	Набережные Челны (8552)20-53-41	Севастополь (8692)22-31-93	Череповец (8202)49-02-64
Иркутск (395)279-98-46	Нижний Новгород (831)429-08-12	Симферополь (3652)67-13-56	Ярославль (4852)69-52-93
Россия (495)268-04-70	Киргизия (996)312-96-26-47	Казахстан (7172)727-132	