

Технические характеристики

По вопросам продаж и поддержки обращайтесь:

Алматы (7273)495-231	Казань (843)206-01-48	Новокузнецк (3843)20-46-81	Смоленск (4812)29-41-54
Архангельск (8182)63-90-72	Калининград (4012)72-03-81	Новосибирск (383)227-86-73	Сочи (862)225-72-31
Астрахань (8512)99-46-04	Калуга (4842)92-23-67	Омск (3812)21-46-40	Ставрополь (8652)20-65-13
Барнаул (3852)73-04-60	Кемерово (3842)65-04-62	Орел (4862)44-53-42	Сургут (3462)77-98-35
Белгород (4722)40-23-64	Киров (8332)68-02-04	Оренбург (3532)37-68-04	Тверь (4822)63-31-35
Брянск (4832)59-03-52	Краснодар (861)203-40-90	Пенза (8412)22-31-16	Томск (3822)98-41-53
Владивосток (423)249-28-31	Красноярск (391)204-63-61	Пермь (342)205-81-47	Тула (4872)74-02-29
Волгоград (844)278-03-48	Курск (4712)77-13-04	Ростов-на-Дону (863)308-18-15	Тюмень (3452)66-21-18
Вологда (8172)26-41-59	Липецк (4742)52-20-81	Рязань (4912)46-61-64	Ульяновск (8422)24-23-59
Воронеж (473)204-51-73	Магнитогорск (3519)55-03-13	Самара (846)206-03-16	Уфа (347)229-48-12
Екатеринбург (343)384-55-89	Москва (495)268-04-70	Санкт-Петербург (812)309-46-40	Хабаровск (4212)92-98-04
Иваново (4932)77-34-06	Мурманск (8152)59-64-93	Саратов (845)249-38-78	Челябинск (351)202-03-61
Ижевск (3412)26-03-58	Набережные Челны (8552)20-53-41	Севастополь (8692)22-31-93	Череповец (8202)49-02-64
Иркутск (395)279-98-46	Нижний Новгород (831)429-08-12	Симферополь (3652)67-13-56	Ярославль (4852)69-52-93
Россия (495)268-04-70	Киргизия (996)312-96-26-47	Казахстан (7172)727-132	

Titanium Ligation Clips and Appliers for Cardiac Surgery

Features

- Narrow Instrument tips.
- Soft load clip cartridge for clip release.
- Indentations on the cartridge sides.
- Adhesive surface on the cartridge.
- Colour coding for identification of suitable clip appliers and cartridges
- A suitable clip applicator for every indication
 - 150 mm, 203 mm and 280 mm instrument lengths
 - 25°, 65° and 90° jaw angulation



FB222R

Clip Applier Forceps, single-fire, 25 °, angled, 150 mm (6"), Size S, yellow, non-sterile, reusable, to be used with: PL565T, PL566T

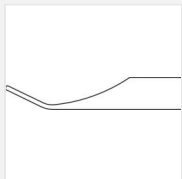

Product search type	Clip Applier Forceps
Aesculap Product	
Groups	Endoscopic Technology, General Surgical Instruments
Product family	Instruments, Ligature Clips
Type	single-fire
Geometry	angled
Degree (°)	25.0 °
Length	150,00 mm
Length (Inch)	6
Figure / Size	Size S
Colour	yellow
To be used with (code)	PL566T, PL565T
Discipline	Ear-Nose-Throat Surgery, Gynaecology, General Surgery, Cardiac Surgery, Maxillo-Facial Surgery, Neurosurgery, Vascular Surgery, Plastic Surgery, Urology, Thoracic Surgery
Indication	Thoracoscopy, Open Surgery, Laparoscopy
Surgical Step	Ligation
Type of Sterilization	not sterilized ex works
Data Matrix	Yes
Product contains Latex	No
Sterility	non-sterile
Disposable / Reusable	reusable

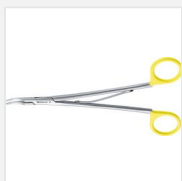

FB223R

Clip Applier Forceps, single-fire, 25 °, angled, 203 mm (8"), Size S, yellow, non-sterile, reusable, to be used with: PL565T, PL566T

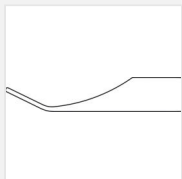

Product search type	Clip Applier Forceps
Aesculap Product	
Groups	General Surgical Instruments, Endoscopic Technology
Product family	Instruments, Ligature Clips
Type	single-fire
Geometry	angled
Degree (°)	25.0 °
Length	203,00 mm
Length (Inch)	8
Figure / Size	Size S
Colour	yellow
To be used with (code)	PL565T, PL566T
Discipline	Ear-Nose-Throat Surgery, General Surgery, Vascular Surgery, Urology, Thoracic Surgery, Plastic Surgery, Neurosurgery, Maxillo-Facial Surgery, Cardiac Surgery, Gynaecology
Indication	Thoracoscopy, Laparoscopy, Open Surgery
Surgical Step	Ligation
Type of Sterilization	not sterilized ex works
Data Matrix	Yes
Product contains Latex	No
Sterility	non-sterile
Disposable / Reusable	reusable



FB224R

Clip Applier Forceps, single-fire, 25 °, angled, 280 mm (11\"/>

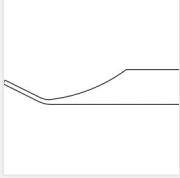

Product search type	Clip Applier Forceps
Aesculap Product	
Groups	Endoscopic Technology, General Surgical Instruments
Product family	Ligature Clips, Instruments
Type	single-fire
Geometry	angled
Degree (°)	25.0 °
Length	280.00 mm
Length (Inch)	11
Figure / Size	Size S
Colour	yellow
To be used with (code)	PL565T, PL566T
Discipline	Vascular Surgery, Urology, Thoracic Surgery, Cardiac Surgery, Gynaecology, General Surgery
Indication	Open Surgery, Thoracoscopy, Laparoscopy
Surgical Step	Ligation
Type of Sterilization	not sterilized ex works
Data Matrix	Yes
Product contains Latex	No
Sterility	non-sterile
Disposable / Reusable	reusable



FB225R

Clip Applier Forceps, single-fire, 90 °, angled, 280 mm, Size S, non-sterile, reusable, to be used with: PL590T



Product search type	Clip Applier Forceps
Aesculap Product	
Groups	Cardiovascu.a.Thoracic Surgery
Product family	Ligature Clips, Instruments
Type	single-fire
Geometry	angled
Degree (°)	90.0 °
Length	280.00 mm
Figure / Size	Size S
To be used with (code)	PL590T
Discipline	Urology, Gynaecology, General Surgery, Vascular Surgery, Thoracic Surgery, Cardiac Surgery
Indication	Heart
Surgical Step	Ligation
Type of Sterilization	not sterilized ex works
Data Matrix	Yes
Product contains Latex	No
Sterility	non-sterile
Disposable / Reusable	reusable



FB226R

Clip Applier Forceps, single-fire, 65 °, angled, 203 mm (8\"/>

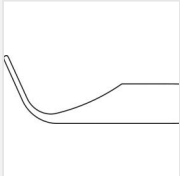

Product search type	Clip Applier Forceps
Aesculap Product	
Groups	Endoscopic Technology, General Surgical Instruments
Product family	Ligature Clips, Instruments
Type	single-fire
Geometry	angled
Degree (°)	65.0 °
Length	203.00 mm
Length (Inch)	8
Figure / Size	Size S
Colour	yellow
To be used with (code)	PL565T, PL566T
Discipline	Ear-Nose-Throat Surgery, General Surgery, Gynaecology, Cardiac Surgery, Maxillo-Facial Surgery, Neurosurgery, Plastic Surgery, Thoracic Surgery, Urology, Vascular Surgery
Indication	Laparoscopy, Thoracoscopy, Open Surgery
Surgical Step	Ligation
Type of Sterilization	not sterilized ex works
Data Matrix	Yes
Product contains Latex	No
Sterility	non-sterile
Disposable / Reusable	reusable



FB227R

Clip Applier Forceps, single-fire, 65 °, angled, 280 mm (11\"/>

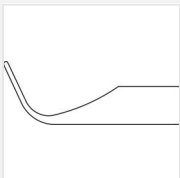

Product search type	Clip Applier Forceps
Aesculap Product	
Groups	Endoscopic Technology, General Surgical Instruments
Product family	Ligature Clips, Instruments
Type	single-fire
Geometry	angled
Degree (°)	65.0 °
Length	280.00 mm
Length (Inch)	11
Figure / Size	Size S
Colour	yellow
To be used with (code)	PL565T, PL566T
Discipline	General Surgery, Gynaecology, Urology, Vascular Surgery
Indication	Thoracoscopy, Open Surgery, Laparoscopy
Surgical Step	Ligation
Type of Sterilization	not sterilized ex works
Data Matrix	Yes
Product contains Latex	No
Sterility	non-sterile
Disposable / Reusable	reusable



FB282R

Clip Removal Forceps, 170 mm (6 3/4\"/>



Product search type	Clip Removal Forceps
Aesculap Product	
Groups	General Surgical Instruments
Length	170.00 mm
Length (Inch)	6 3/4
Discipline	Neurosurgery
Type of Sterilization	not sterilized ex works
Data Matrix	Yes
Product contains Latex	No
Sterility	non-sterile
Disposable / Reusable	reusable



PL565T

Single fire clips, titanium, small, yellow, 4 mm, 3.1 mm, sterile, package of 30 cartridges, to be used with FB222R; FB223R; FB226R; FB224R; FB227R

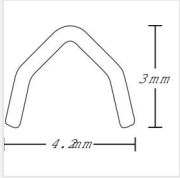

Product search type	Ligature Clip
Aesculap Product	
Groups	Endoscopic Technology, General Surgical Instruments
Product family	Ligature Clips
Type	single-fire
Opening Width (mm)	4.0 mm
Jaw/Blade Length (mm)	3.10 mm
Usable Length of the Jaw	3.1 mm
Figure / Size	Size S
Colour	yellow
Material	titanium
To be used with (code)	FB226R, FB224R, FB223R, FB227R, FB222R
Indication	Laparoscopy, Open Surgery, Thoracoscopy, Endoscopy
Discipline	Vascular Surgery, Plastic Surgery, Spine Surgery, Orthopaedics, Maxillo-Facial Surgery, Cardiac Surgery, Neurosurgery, Gynaecology, General Surgery, Thoracic Surgery, Ear-Nose-Throat Surgery, Traumatology, Urology
Surgical Step	Ligation
Sales unit	box of 30 cartridges à 6 clips
Product contains Latex	No
Sterility	sterile
Disposable / Reusable	disposable



PL566T

Single fire clips, titanium, small, yellow, 4 mm, 3.1 mm, sterile, package of 8 cartridges à 24 clips, to be used with FB222R; FB223 R; FB226R; FB224R; FB227R

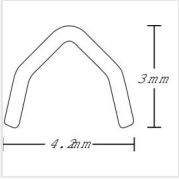

Product search type	Ligature Clip
Aesculap Product Groups	General Surgical Instruments, Endoscopic Technology
Product family	Ligature Clips
Type	single-fire
Opening Width (mm)	4.0 mm
Jaw/Blade Length (mm)	3.10 mm
Usable Length of the Jaw	3.1 mm
Figure / Size	Size S
Colour	yellow
Material	titanium
To be used with (code)	FB226R, FB224R, FB223R, FB227R, FB222R
Indication	Endoscopy, Laparoscopy, Thoracoscopy, Open Surgery
Discipline	Traumatology, Thoracic Surgery, Vascular Surgery, Ear-Nose-Throat Surgery, General Surgery, Gynaecology, Cardiac Surgery, Maxillo-Facial Surgery, Neurosurgery, Orthopaedics, Plastic Surgery, Urology, Spine Surgery
Surgical Step	Ligation
Sales unit	box of 8 cartridges à 24 clips
Product contains Latex	No
Sterility	sterile
Disposable / Reusable	disposable



PL567T

Single fire clips, titanium, medium, blue, 6.2 mm, 4.9 mm, sterile, package of 30 cartridges, to be used with FB234R; FB235R; FB238R ; FB236R; FB239R; PL504R

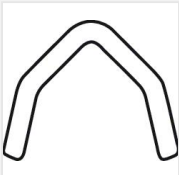
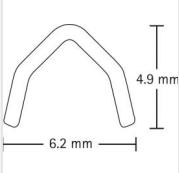

Product search type	Ligature Clip
Aesculap Product Groups	General Surgical Instruments, Endoscopic Technology
Product family	Ligature Clips
Type	single-fire
Length	4.90 mm
Opening Width (mm)	6.2 mm
Figure / Size	Size M
Colour	blue
Material	titanium
To be used with (code)	FB238R, FB236R, FB235R, PL504R, FB239R, FB234R
Indication	Endoscopy, Laparoscopy, Thoracoscopy, Open Surgery
Discipline	Maxillo-Facial Surgery, Thoracic Surgery, Traumatology, Ear-Nose-Throat Surgery, Neurosurgery, Spine Surgery, Plastic Surgery, Urology, Vascular Surgery, Cardiac Surgery, Gynaecology, Orthopaedics, General Surgery
Surgical Step	Ligation
Sales unit	box of 30 cartridges à 6 clips
Product contains Latex	No
Sterility	sterile
Disposable / Reusable	disposable



PL574T

CHALLENGER TI-P SM-LIGAT.CLIPS 12 CARTR.

Product search type	Ligature Clip
Brand name	CHALLENGER TI-P
Aesculap Product	
Groups	Endoscopic Technology
Product family	Ligature Clips
Type	multi-fire, pneumatic
Length	4.00 mm
Opening Width (mm)	4.5 mm
Figure / Size	Size SM
Material	titanium
To be used with (code)	PL604R, PL603R
Indication	Laparoscopy, Thoracoscopy, Endoscopy
Minimally Invasive	
Surg. (MIS)	Yes
Discipline	Urology, Vascular Surgery, Traumatology, Thoracic Surgery, Spine Surgery, Plastic Surgery, Orthopaedics, Neurosurgery, Maxillo-Facial Surgery, Cardiac Surgery, Gynaecology, General Surgery, Ear-Nose-Throat Surgery
Surgical Step	Ligation
Sales unit	box of 12 cartridges à 12 clips
Product contains Latex	No
Sterility	sterile
Disposable / Reusable	disposable



PL603R

CHALLENGER TI-P Clip Applier Forceps, pneumatic, multi-fire, working length: 205 mm, diam. 5 mm, Size SM, consisting of PL520R, PL609R, non-sterile, reusable, to be used with: PL574T

Product search type	Clip Applier Forceps
Brand name	CHALLENGER TI-P
Aesculap Product	
Groups	Endoscopic Technology
Product family	Instruments
Type	pneumatic, multi-fire
Working length (mm)	205.0 mm
Working length (Inch)	8
Diameter (mm)	5.00 mm
Figure / Size	Size SM
consisting parts	PL520R, PL609R
To be used with (code)	PL574T
Minimally Invasive	
Surg. (MIS)	Yes
Indication	Endoscopy, Thoracoscopy, Laparoscopy
Surgical Step	Ligation
Recommended care articles	GK469R, PL522810, JG600
Type of Sterilization	not sterilized ex works
Data Matrix	No
Product contains Latex	No
Sterility	non-sterile
Disposable / Reusable	reusable



PL604R

CHALLENGER TI-P Clip Applier Forceps, pneumatic, multi-fire, working length: 310 mm (12 1/4"), diam. 5 mm, Size SM, consisting of PL520R, PL522R, non-sterile, reusable, to be used with: PL574T

Product search type	Clip Applier Forceps
Brand name	CHALLENGER TI-P
Aesculap Product	
Groups	Endoscopic Technology
Product family	Instruments
Type	multi-fire, pneumatic
Working length (mm)	310.0 mm
Working length (Inch)	12 1/4
Diameter (mm)	5.00 mm
Figure / Size	Size SM
consisting parts	PL522R, PL520R
To be used with (code)	PL574T
Minimally Invasive	
Surg. (MIS)	Yes
Indication	Thoracoscopy, Laparoscopy, Endoscopy
Surgical Step	Ligation
Recommended care articles	GK469R, JG600, PL522810
Type of Sterilization	not sterilized ex works
Data Matrix	No
Product contains Latex	No
Sterility	non-sterile
Disposable / Reusable	reusable



PL561T

Single fire clips, titanium, large, orange, 11 mm, 10.7 mm, sterile, package of 20 cartridges, to be used with FB246R; FB249R; FB252 R; FB248R; FB251R; FB253R; PL528R

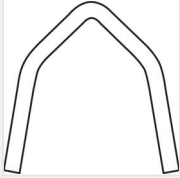
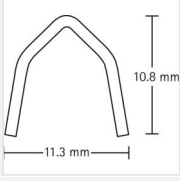

Product search type	Ligature Clip
Aesculap Product	
Groups	Endoscopic Technology, General Surgical Instruments
Product family	Ligature Clips
Type	single-fire
Length	10.70 mm
Opening Width (mm)	11.0 mm
Figure / Size	Size L
Colour	orange
Material	titanium
To be used with (code)	FB252R, FB249R, FB248R, FB253R, PL528R, FB251R, FB246R
Indication	Laparoscopy, Thoracoscopy, Open Surgery, Endoscopy
Discipline	Vascular Surgery, Urology, Traumatology, Thoracic Surgery, Spine Surgery, Plastic Surgery, Orthopaedics, Neurosurgery, Ear-Nose-Throat Surgery, Maxillo-Facial Surgery, General Surgery, Gynaecology, Cardiac Surgery
Surgical Step	Ligation
Sales unit	box of 20 cartridges à 6 clips
Product contains Latex	No
Sterility	sterile
Disposable / Reusable	disposable



PL565T

Single fire clips, titanium, small, yellow, 4 mm, 3.1 mm, sterile, package of 30 cartridges, to be used with FB222R; FB223R; FB226R; FB224R; FB227R

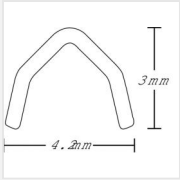

Product search type	Ligature Clip
Aesculap Product	
Groups	Endoscopic Technology, General Surgical Instruments
Product family	Ligature Clips
Type	single-fire
Opening Width (mm)	4.0 mm
Jaw/Blade Length (mm)	3.10 mm
Usable Length of the Jaw	3.1 mm
Figure / Size	Size S
Colour	yellow
Material	titanium
To be used with (code)	FB226R, FB224R, FB223R, FB227R, FB222R
Indication	Laparoscopy, Open Surgery, Thoracoscopy, Endoscopy
Discipline	Vascular Surgery, Plastic Surgery, Spine Surgery, Orthopaedics, Maxillo-Facial Surgery, Cardiac Surgery, Neurosurgery, Gynaecology, General Surgery, Thoracic Surgery, Ear-Nose-Throat Surgery, Traumatology, Urology
Surgical Step	Ligation
Sales unit	box of 30 cartridges à 6 clips
Product contains Latex	No
Sterility	sterile
Disposable / Reusable	disposable



PL566T

Single fire clips, titanium, small, yellow, 4 mm, 3.1 mm, sterile, package of 8 cartridges à 24 clips, to be used with FB222R; FB223 R; FB226R; FB224R; FB227R

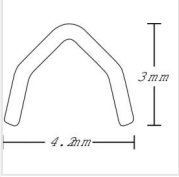

Product search type	Ligature Clip
Aesculap Product	
Groups	General Surgical Instruments, Endoscopic Technology
Product family	Ligature Clips
Type	single-fire
Opening Width (mm)	4.0 mm
Jaw/Blade Length (mm)	3.10 mm
Usable Length of the Jaw	3.1 mm
Figure / Size	Size S
Colour	yellow
Material	titanium
To be used with (code)	FB226R, FB224R, FB223R, FB227R, FB222R
Indication	Endoscopy, Laparoscopy, Thoracoscopy, Open Surgery
Discipline	Traumatology, Thoracic Surgery, Vascular Surgery, Ear-Nose-Throat Surgery, General Surgery, Gynaecology, Cardiac Surgery, Maxillo-Facial Surgery, Neurosurgery, Orthopaedics, Plastic Surgery, Urology, Spine Surgery
Surgical Step	Ligation
Sales unit	box of 8 cartridges à 24 clips
Product contains Latex	No
Sterility	sterile
Disposable / Reusable	disposable



PL567T

Single fire clips, titanium, medium, blue, 6.2 mm, 4.9 mm, sterile, package of 30 cartridges, to be used with FB234R; FB235R; FB238R ; FB236R; FB239R; PL504R

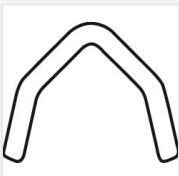
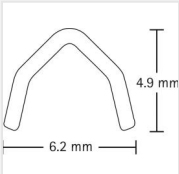

Product search type	Ligature Clip
Aesculap Product	
Groups	General Surgical Instruments, Endoscopic Technology
Product family	Ligature Clips
Type	single-fire
Length	4.90 mm
Opening Width (mm)	6.2 mm
Figure / Size	Size M
Colour	blue
Material	titanium
To be used with (code)	FB238R, FB236R, FB235R, PL504R, FB239R, FB234R
Indication	Endoscopy, Laparoscopy, Thoracoscopy, Open Surgery
Discipline	Maxillo-Facial Surgery, Thoracic Surgery, Traumatology, Ear-Nose-Throat Surgery, Neurosurgery, Spine Surgery, Plastic Surgery, Urology, Vascular Surgery, Cardiac Surgery, Gynaecology, Orthopaedics, General Surgery
Surgical Step	Ligation
Sales unit	box of 30 cartridges à 6 clips
Product contains Latex	No
Sterility	sterile
Disposable / Reusable	disposable



PL568T

Single fire clips, titanium, medium-large, green, 8.1 mm, 7.9 mm, sterile, package of 20 cartridges, to be used with FB240R; FB243R; FB254R; FB242R; FB245R; FB255R; PL503R

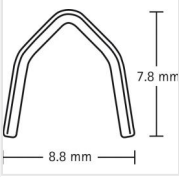

Product search type	Ligature Clip
Aesculap Product	
Groups	Endoscopic Technology, General Surgical Instruments
Product family	Ligature Clips
Type	single-fire
Length	7.90 mm
Opening Width (mm)	8.1 mm
Figure / Size	Size ML
Colour	green
Material	titanium
To be used with (code)	FB240R, FB254R, FB245R, PL503R, FB255R, FB242R, FB243R
Indication	Thoracoscopy, Laparoscopy, Open Surgery, Endoscopy
Discipline	Vascular Surgery, Urology, Traumatology, Thoracic Surgery, Spine Surgery, Plastic Surgery, Orthopaedics, Neurosurgery, Maxillo-Facial Surgery, Cardiac Surgery, Gynaecology, General Surgery, Ear-Nose-Throat Surgery
Surgical Step	Ligation
Sales unit	box of 20 cartridges à 6 clips
Product contains Latex	No
Sterility	sterile
Disposable / Reusable	disposable

Titanium Standard Forceps

- Non-reflecting surface finish.
- Fatigue-free lightness.
- Blue handle for definite identification of an Aesculap Titanium Instrument.

For more information about Titanium forceps see our brochure number **DOC890**.

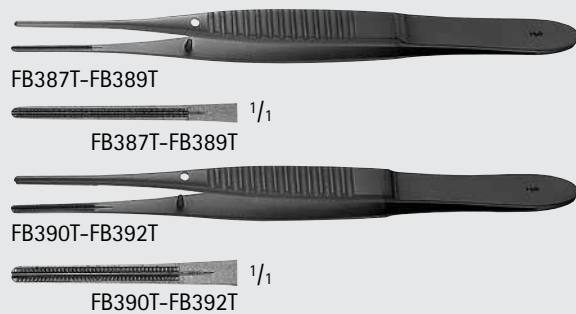

Titanium DEBAKEY Atraumatic Forceps

Catalog Number	Tip Size (mm)	Length (in.)
FB387T	1.5	5 3/4
FB388T	1.5	7 3/4
FB389T	1.5	9 1/2
FB390T	2.5	5 3/4
FB391T	2.5	7 3/4
FB392T	2.5	9 1/2



Titanium Micro ADSON Dissecting Forceps

Catalog Number	Tip	Length (in.)
BD221T	SERR	4 3/4

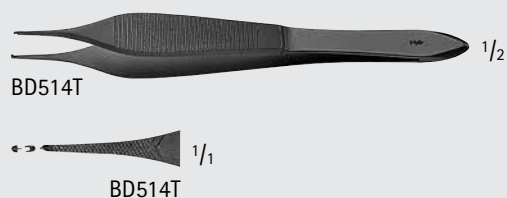

Titanium Micro ADSON Tissue Forceps, Delicate

Catalog Number	Tip	Teeth	Length (in.)
BD514T	SERR	1 x 2	4 3/4

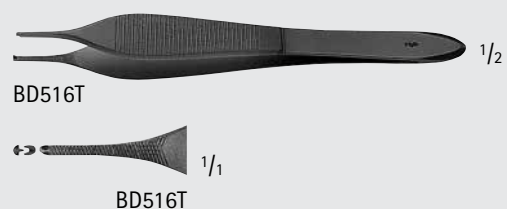

Titanium Micro ADSON Tissue Forceps

Catalog Number	Tip	Teeth	Length (in.)
BD516T	SERR	1 x 2	4 3/4

Cardiovascular

Titanium Forceps

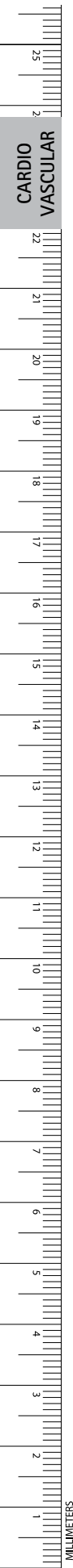

CARDIO
VASCULAR



BD227T

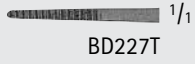

BD227T

Titanium GERALD Dissecting Forceps, Delicate

Catalog Number	Tip	Length (in.)
BD227T	SERR	6 3/4



BD657T

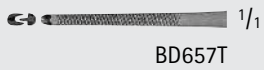

BD657T

Titanium GERALD Tissue Forceps

Catalog Number	Tip	Teeth	Length (in.)
BD657T	SERR	1 x 2	6 3/4



BD715T



BD715T

Titanium RESANO Grasping Forceps

Catalog Number	Tip	Length (in.)
BD715T	SERR	9



Titanium Ringhandled Instruments

- Non-reflecting surface finish.
- Fatigue-free lightness.
- Blue rings for definite identification of an Aesculap Titanium Instrument.

For more information about Titanium Ringhandled Instruments see our brochure number DOC890.

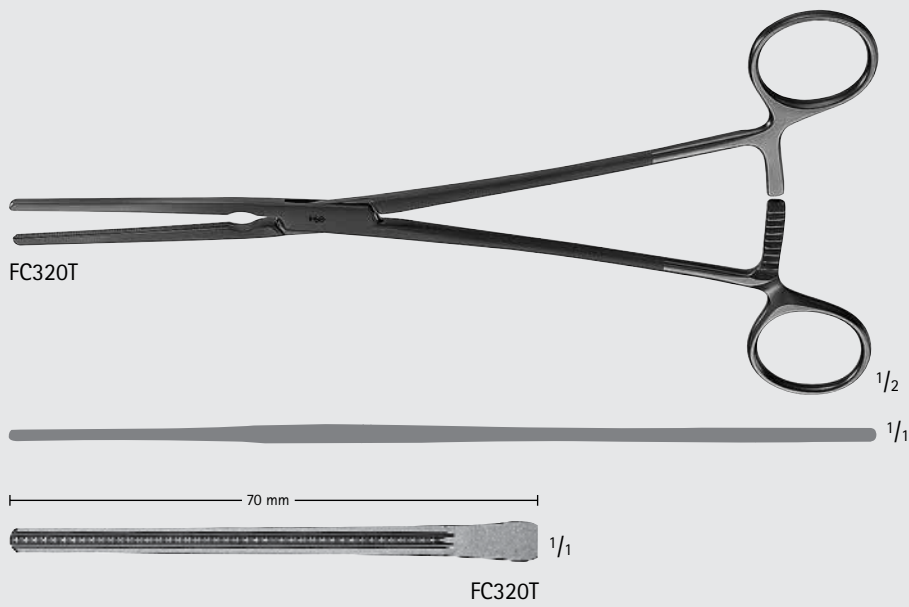

Titanium DEBAKEY Atraumatic
Vascular Clamp

Catalog Number	Jaw	Jaw Length (mm)	Length (in.)
FC320T	STR	70	9

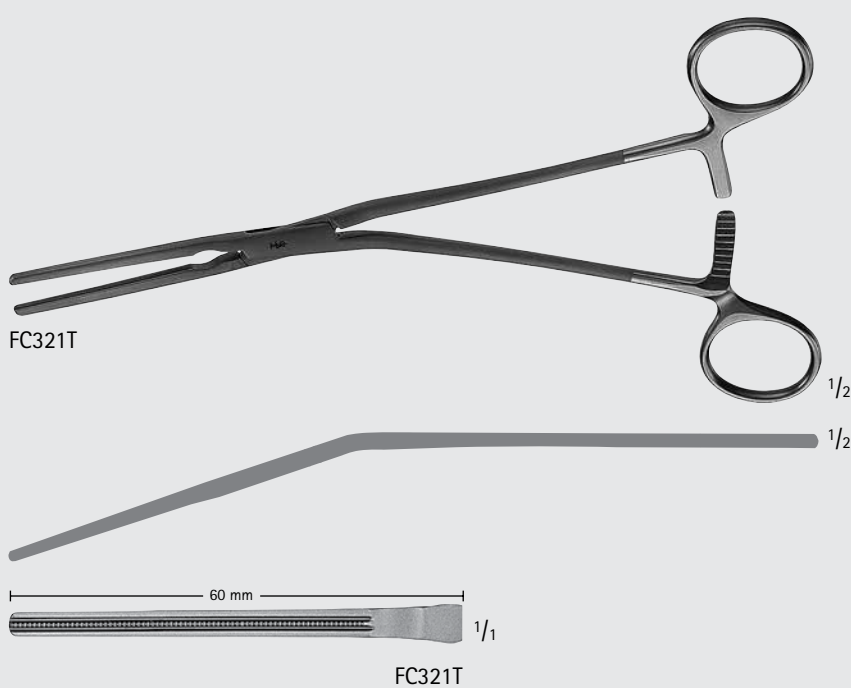

Titanium DEBAKEY Atraumatic
Vascular Clamp

Catalog Number	Jaw	Jaw Length (mm)	Shaft	Length (in.)
FC321T	STR	60	ANG	8 1/2

Cardiovascular

Titanium Clamps

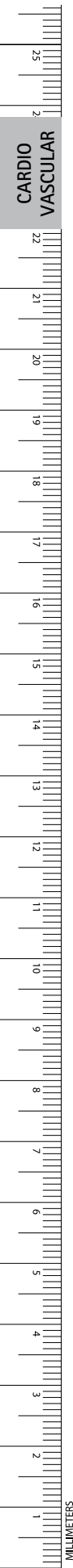

CARDIO
VASCULAR

FC322T-FC323T

15 mm

70 mm

FC322T 1/1

17 mm

75 mm

FC323T 1/1

Titanium DEBAKEY Atraumatic Vascular Clamp

Catalog Number	Jaw	Jaw Length (mm)	Length (in.)
FC322T	CVD	70	8 7/8
FC323T	CVD	75	9 5/8

FC324T-FC325T

60 mm

8 mm

FC324T 1/1

80 mm

11 mm

FC325T 1/1

Titanium GLOVER Atraumatic Vascular Clamp

Catalog Number	Jaw	Jaw Length (mm)	Length (in.)
FC324T	CVD	60	8 3/4
FC325T	CVD	80	10 5/8

Cardiovascular Titanium Clamps

Titanium LAMBERT-KAY Atraumatic Vascular Clamp

Catalog Number	Jaw Angle	Jaw Length (mm)	Shaft	Length (in.)
FC326T	MULTI	45	ANG	7 3/4

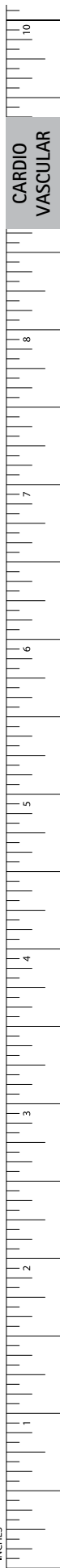
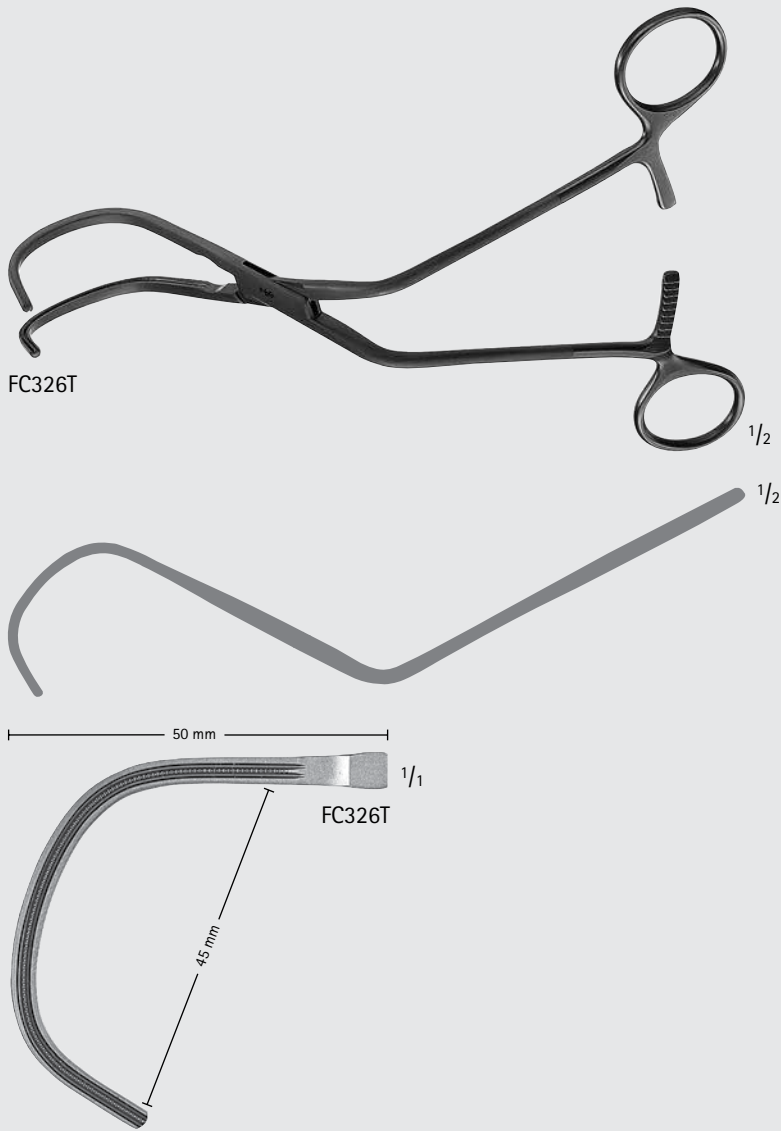

Cardiovascular

Titanium Clamps

Titanium DEBAKEY Atraumatic Vascular Clamp

Catalog Number	Jaw	Length (in.)
FC327T	SLIGHT-CVD	12 1/4
FC328T	SLIGHT-CVD	12 1/2

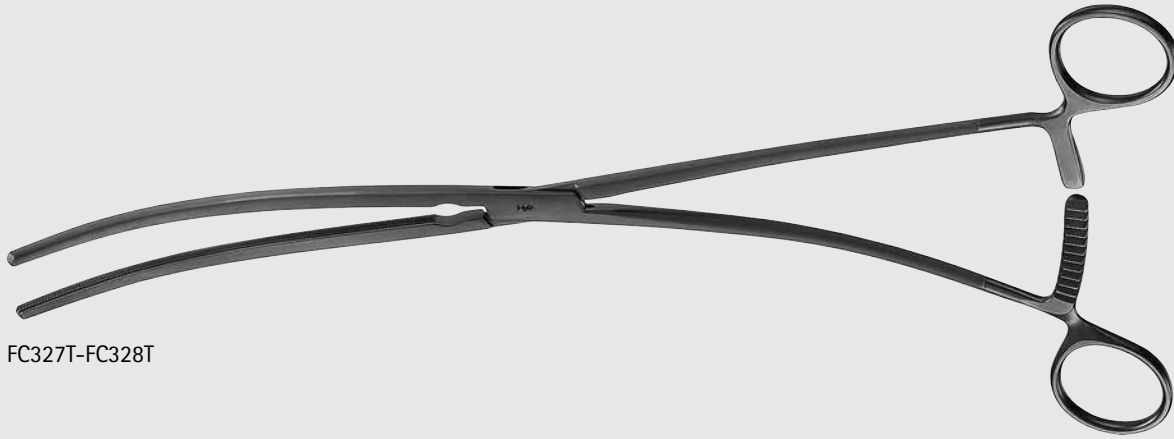

FC327T-FC328T

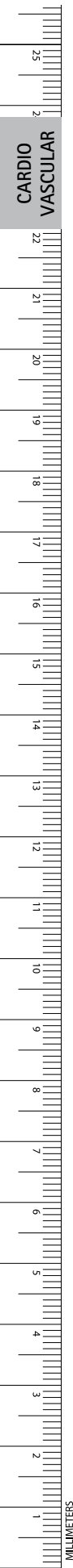
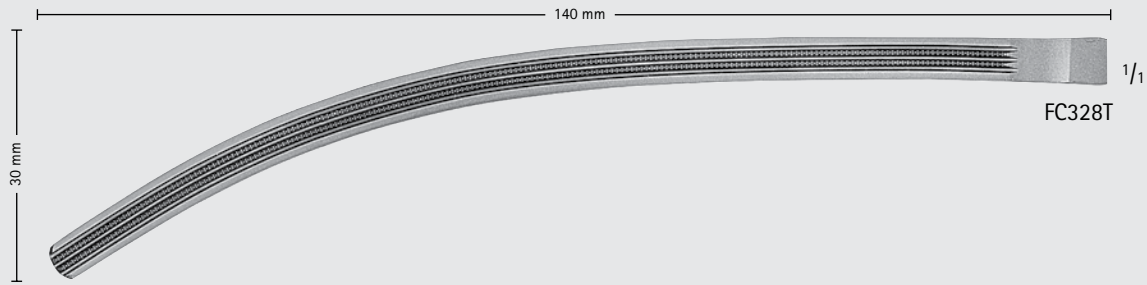
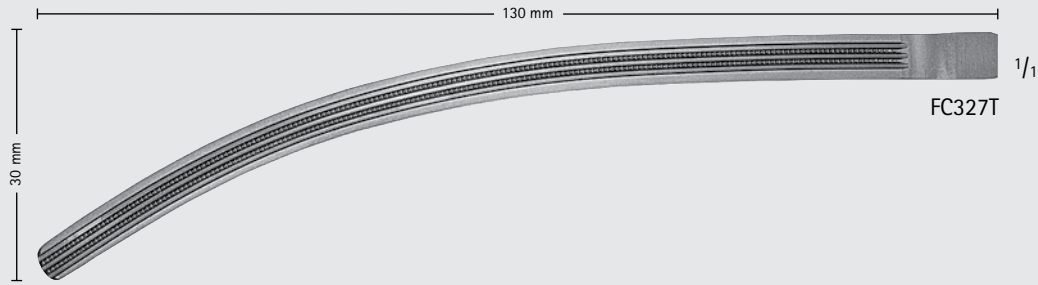

MILLIMETERS

Cardiovascular Titanium Clamps

Titanium DEBAKEY Atraumatic Vascular Clamp

Catalog Number	Jaw	Shaft	Length (in.)
FC331T	CVD	ANG	7 3/4
FC330T	ANG	ANG	7



FC330T-FC331T



1/2

65 mm

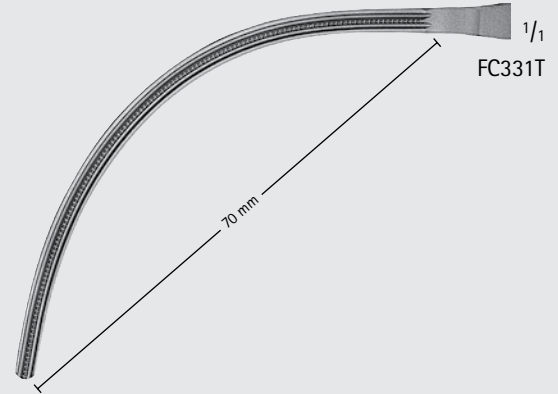

1/1
FC331T

70 mm



1/2

55 mm

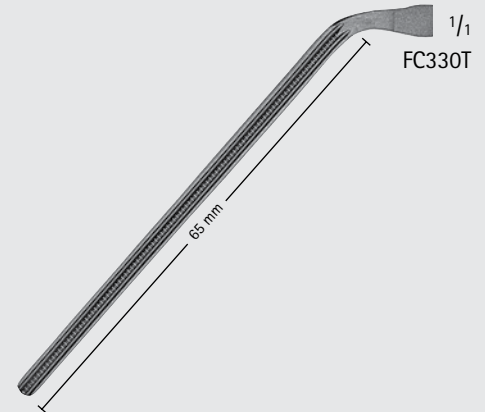

1/1
FC330T

65 mm

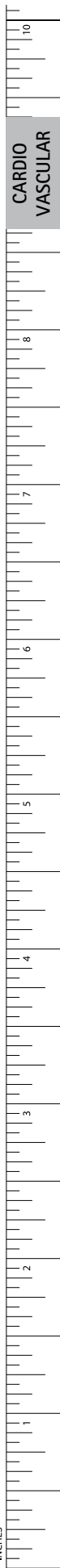

INCHES

Cardiovascular

Titanium Clamps

Titanium DEBAKEY Atraumatic Vascular Clamp

Catalog Number	Jaw	Length (in.)
FC329T	HEAVY-CVD	10 1/4

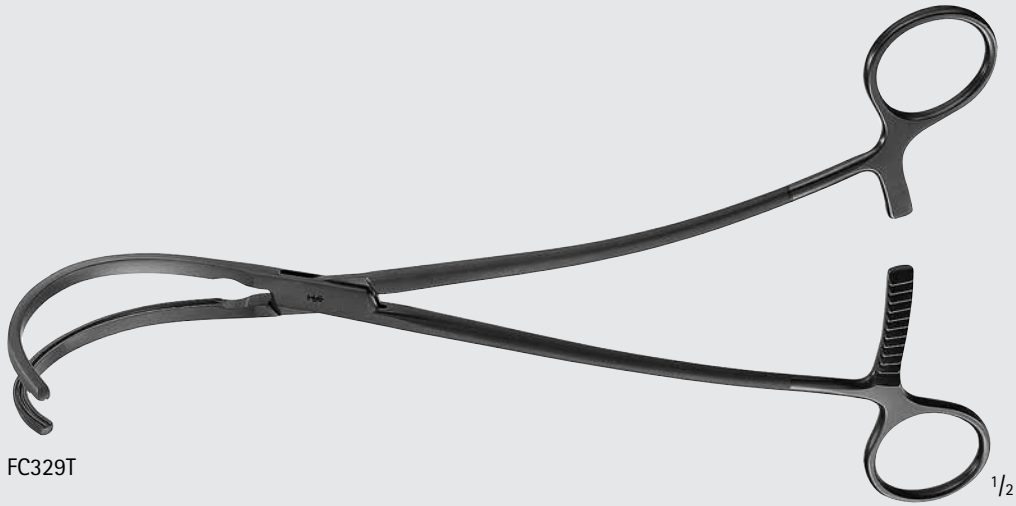

FC329T

1/2



1/2

60 mm

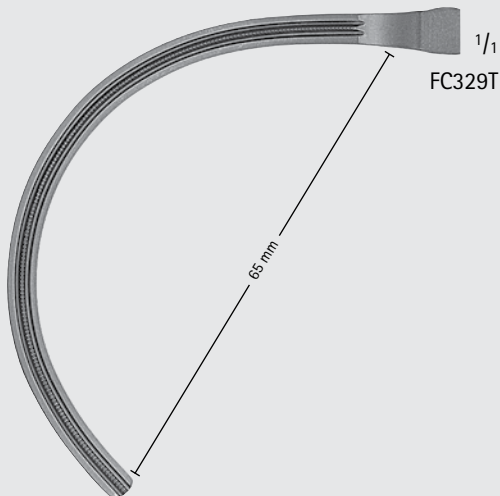

1/1

FC329T

65 mm

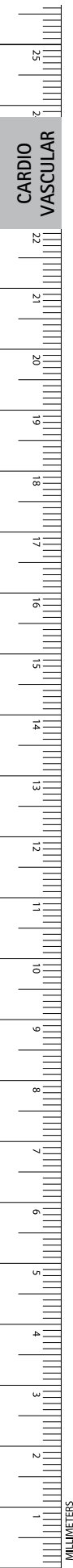

CARDIO
VASCULAR

MILLIMETERS

Cardiovascular Titanium Clamps

Titanium DEBAKEY Atraumatic Vascular Clamp

Catalog Number	Jaw	Shaft	Length (in.)
FC332T	ANG	ANG	9 1/2
FC333T	ANG	ANG	8 1/2



FC332T-FC333T

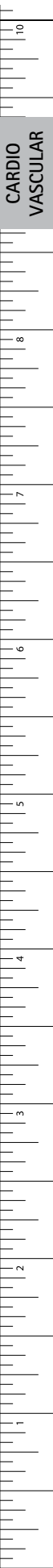
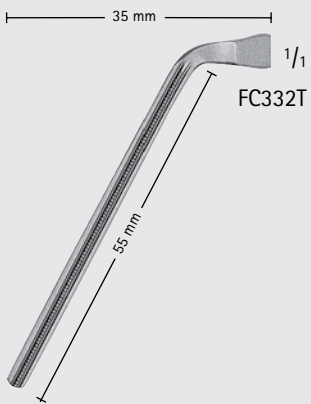

Cardiovascular

Titanium Clamps

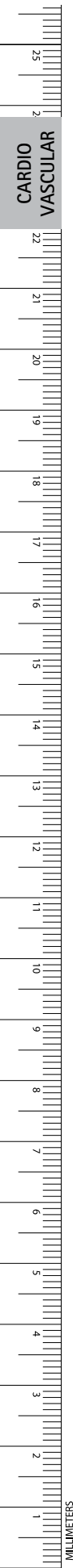

CARDIO
VASCULAR

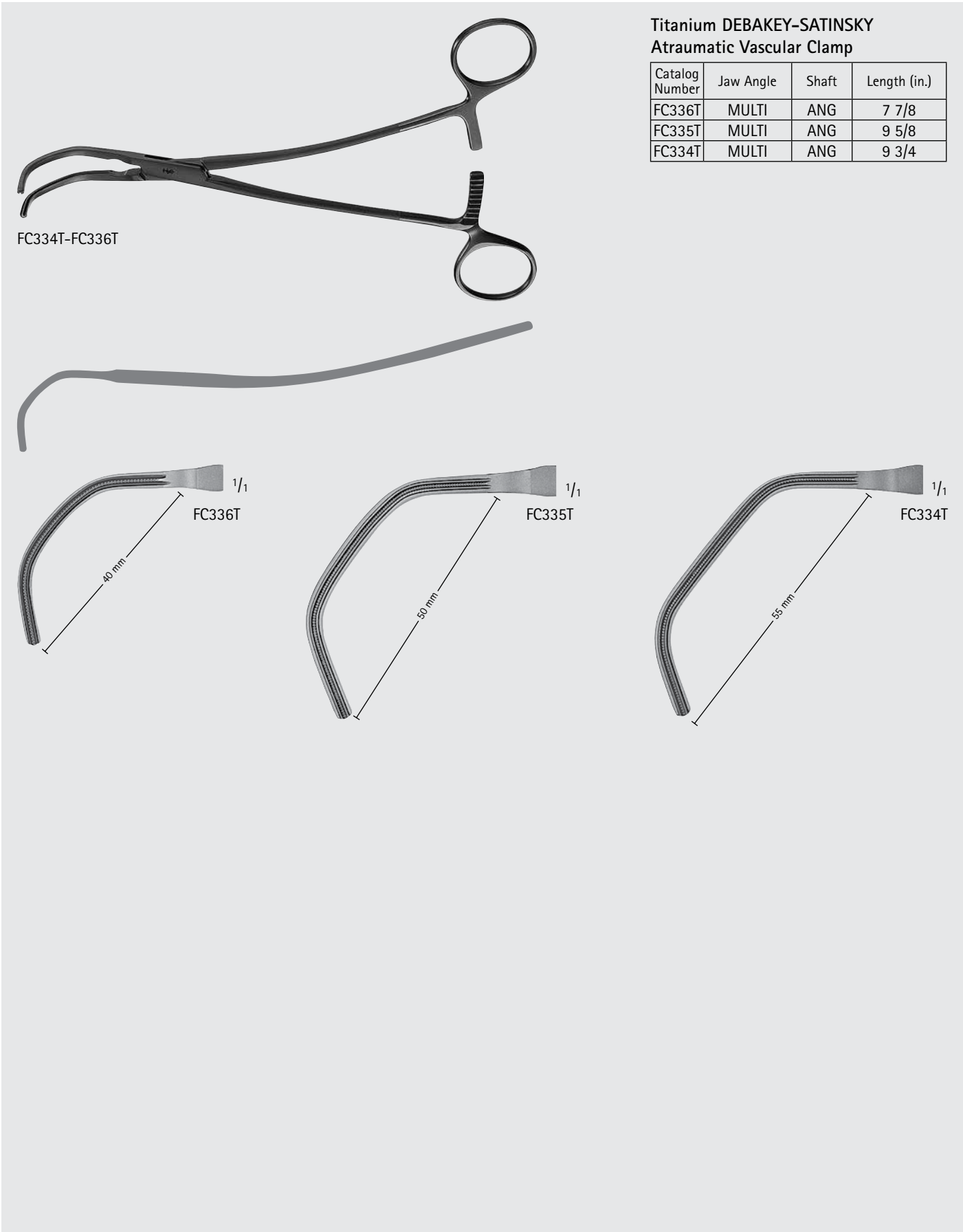

FC334T-FC336T

FC336T

40 mm

FC335T

50 mm

FC334T

55 mm

Titanium DEBAKEY-SATINSKY Atraumatic Vascular Clamp

Catalog Number	Jaw Angle	Shaft	Length (in.)
FC336T	MULTI	ANG	7 7/8
FC335T	MULTI	ANG	9 5/8
FC334T	MULTI	ANG	9 3/4

Cardiovascular Titanium Clamps

Titanium DEBAKEY Atraumatic Pediatric Vascular Clamp

Catalog Number	Jaw Angle	Length (in.)
FC337T	STR	4 1/4
FC338T	30°	4 1/4
FC339T	45°	4 1/4
FC340T	60°	4 1/4
FC341T	MULTI	3 3/4
FC342T	MULTI	4
FC343T	MULTI	4

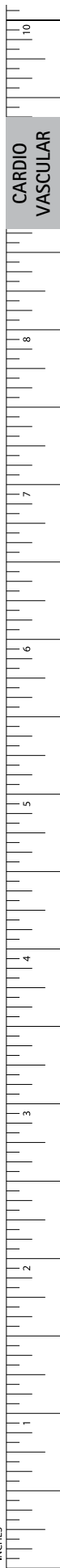
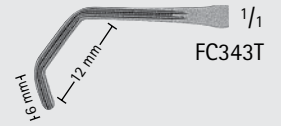
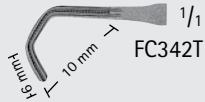
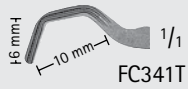
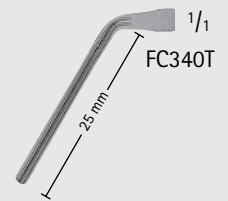
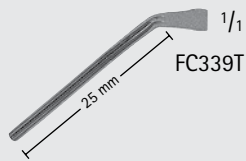
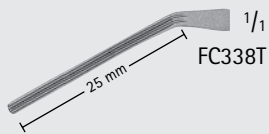
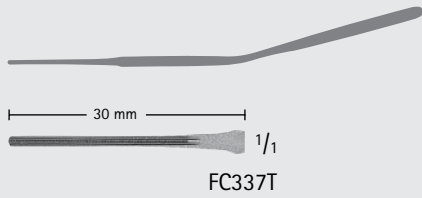
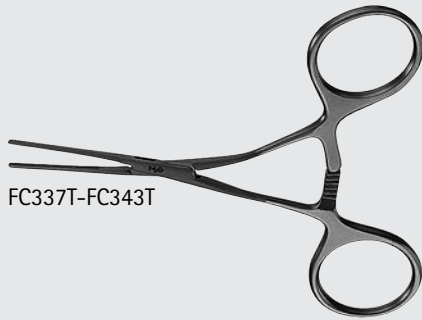

Cardiovascular

Titanium, Dia Dust™, DUROGRIP™ TC Needle Holders

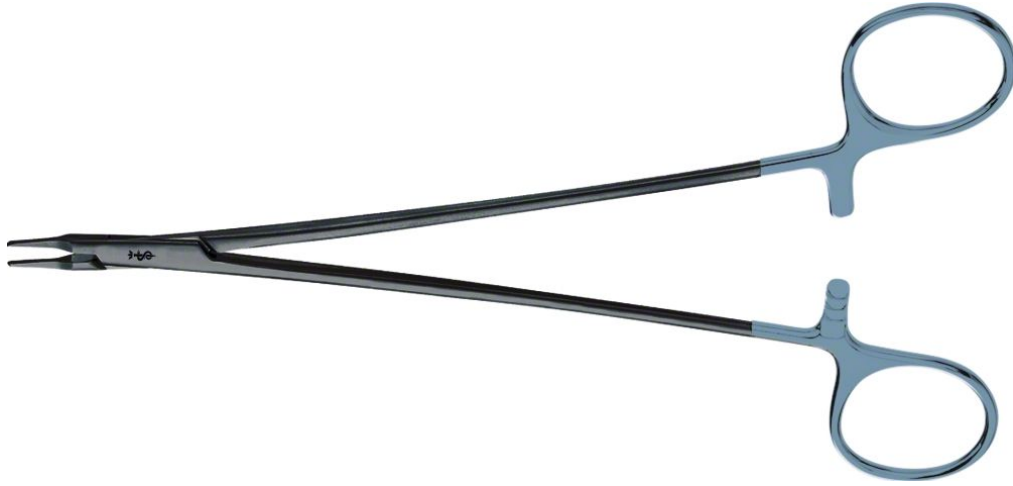

Titanium Dia Dust RYDER Needle Holder

Catalog Number	Tip	Suture Size	Length (in.)
BM385T	X-DEL	5/0 AND SMALLER	6 1/4
BM386T	X-DEL	5/0 AND SMALLER	7
BM387T	X-DEL	5/0 AND SMALLER	8 1/4

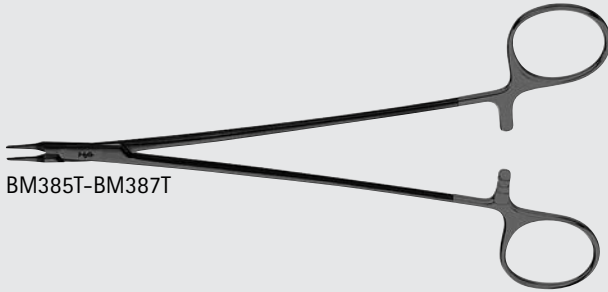

BM385T-BM387T



BM385T

BM386T

BM387T

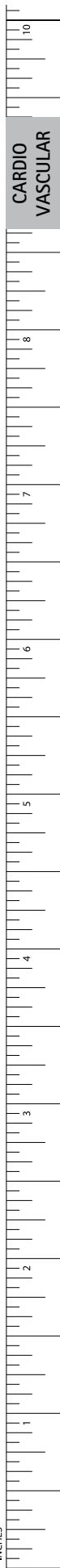

CARDIO
VASCULAR

Cardiovascular

Titanium Micro Needle Holders

Aesculap Titanium Micro Instruments

- The extremely light Titanium material is an advantage for lengthy cardiac and vascular operations. This helps to carry on operating over longer time periods with minimum fatigue.
- The non-magnetic material makes working with particularly fine needles easier for you.
- Non-reflecting surface finish.
- Incomparable operating sensitivity: the Aesculap golf ball handle design.
- Unmistakable identification: the Aesculap color code.

For more information about Titanium Micro Instruments see our brochure number DOC890.



All needle holder jaws are coated with Aesculap Dia Dust™ diamond dust coating. This coating ensures that the inner surfaces provide the best possible performance in hardness and wear resistance. The texture of the jaws greatly increases its surface area, allowing you to grasp fine needles, sutures and soft tissue safely and securely. The needle quickly aligns itself in an ideal position in the rough surface. This results in a perfect grip that quite simply prevents any needle slippage.

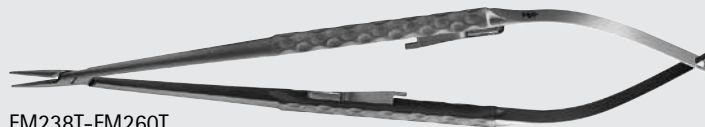

FM238T-FM260T

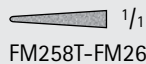

Titanium Micro Needle Holder, Golf Ball Handle Design W/ Catch

Catalog Number	Tip	Suture Size	Handle Color	Length (in.)
FM258T	STR	7/0 AND SMALLER	GREEN	7 1/4
FM259T	STR	7/0 AND SMALLER	GREEN	8 1/4
FM260T	STR	7/0 AND SMALLER	GREEN	9
FM238T	STR	5/0 AND SMALLER	BLUE	7 1/4
FM239T	STR	5/0 AND SMALLER	BLUE	8 1/4
FM240T	STR	5/0 AND SMALLER	BLUE	9

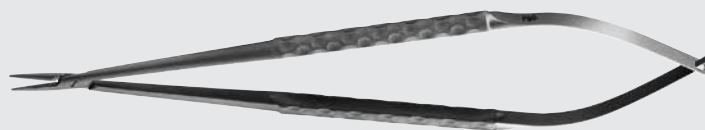

FM232T-FM254T



Titanium Micro Needle Holder, Golf Ball Handle Design W/O Catch

Catalog Number	Tip	Suture Size	Handle Color	Length (in.)
FM252T	STR	7/0 AND SMALLER	GREEN	7 1/4
FM253T	STR	7/0 AND SMALLER	GREEN	8 1/4
FM254T	STR	7/0 AND SMALLER	GREEN	9
FM232T	STR	5/0 AND SMALLER	BLUE	7 1/4
FM233T	STR	5/0 AND SMALLER	BLUE	8 1/4
FM234T	STR	5/0 AND SMALLER	BLUE	9

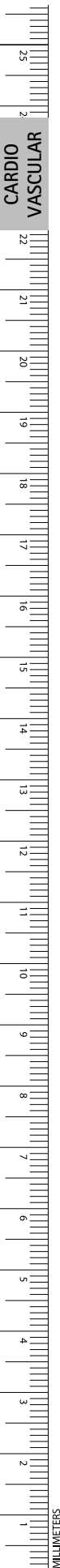

Cardiovascular

Titanium Forceps

Aesculap Titanium Micro Instruments

- The extremely light Titanium material is an advantage for lengthy cardiac and vascular operations. This helps to carry on operating over longer time periods with minimum fatigue.
- Non-reflecting surface finish - for optimal glare reduction.
- The Aesculap golf ball handle design - gives incomparable operating sensitivity.
- The Aesculap color code - provides unmistakable instrument identification.

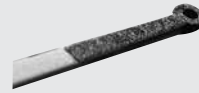

All titanium forceps jaws are coated with Aesculap Dia Dust™ diamond dust coating. This coating ensures that the inner surfaces provide the best possible performance in hardness and wear resistance. The texture of the jaws greatly increases its surface area, allowing you to grasp sutures and soft tissue safely and securely.

For more information about Titanium Micro Instruments see our brochure number **DOC890**.



FM317T-FM319T

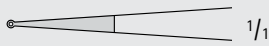

FM317T-FM319T

Titanium Micro Ring Forceps, Golf Ball Handle

Catalog Number	Diam. of Ring (mm)	Tip	Handle Color	Counter-balance	Length (in.)
FM317T	1.0	DIA DUST	BLUE	NO	7 1/4
FM318T	1.0	DIA DUST	BLUE	NO	8 1/4
FM319T	1.0	DIA DUST	BLUE	NO	9



FM327T-FM329T



FM327T-FM329T

Titanium Micro Forceps, W/ Platform, Golf Ball Handle

Catalog Number	Tip	Handle Color	Counter-balance	Length (in.)
FM327T	DIA DUST	GREEN	NO	7 1/4
FM328T	DIA DUST	GREEN	NO	8 1/4
FM329T	DIA DUST	GREEN	NO	9



FM337T-FM339T



FM337T-FM339T

Titanium Micro Forceps, Golf Ball Handle

Catalog Number	Tip	Handle Color	Counter-balance	Length (in.)
FM337T	DEBAKEY	PURPLE	NO	7 1/4
FM338T	DEBAKEY	PURPLE	NO	8 1/4
FM339T	DEBAKEY	PURPLE	NO	9



По вопросам продаж и поддержки обращайтесь:

Алматы (7273)495-231	Казань (843)206-01-48	Новокузнецк (3843)20-46-81	Смоленск (4812)29-41-54
Архангельск (8182)63-90-72	Калининград (4012)72-03-81	Новосибирск (383)227-86-73	Сочи (862)225-72-31
Астрахань (8512)99-46-04	Калуга (4842)92-23-67	Омск (3812)21-46-40	Ставрополь (8652)20-65-13
Барнаул (3852)73-04-60	Кемерово (3842)65-04-62	Орел (4862)44-53-42	Сургут (3462)77-98-35
Белгород (4722)40-23-64	Киров (8332)68-02-04	Оренбург (3532)37-68-04	Тверь (4822)63-31-35
Брянск (4832)59-03-52	Краснодар (861)203-40-90	Пенза (8412)22-31-16	Томск (3822)98-41-53
Владивосток (423)249-28-31	Красноярск (391)204-63-61	Пермь (342)205-81-47	Тула (4872)74-02-29
Волгоград (844)278-03-48	Курск (4712)77-13-04	Ростов-на-Дону (863)308-18-15	Тюмень (3452)66-21-18
Вологда (8172)26-41-59	Липецк (4742)52-20-81	Рязань (4912)46-61-64	Ульяновск (8422)24-23-59
Воронеж (473)204-51-73	Магнитогорск (3519)55-03-13	Самара (846)206-03-16	Уфа (347)229-48-12
Екатеринбург (343)384-55-89	Москва (495)268-04-70	Санкт-Петербург (812)309-46-40	Хабаровск (4212)92-98-04
Иваново (4932)77-34-06	Мурманск (8152)59-64-93	Саратов (845)249-38-78	Челябинск (351)202-03-61
Ижевск (3412)26-03-58	Набережные Челны (8552)20-53-41	Севастополь (8692)22-31-93	Череповец (8202)49-02-64
Иркутск (395)279-98-46	Нижний Новгород (831)429-08-12	Симферополь (3652)67-13-56	Ярославль (4852)69-52-93
Россия (495)268-04-70	Киргизия (996)312-96-26-47	Казахстан (7172)727-132	