

Технические характеристики

По вопросам продаж и поддержки обращайтесь:

Алматы (7273)495-231	Казань (843)206-01-48	Новокузнецк (3843)20-46-81	Смоленск (4812)29-41-54
Архангельск (8182)63-90-72	Калининград (4012)72-03-81	Новосибирск (383)227-86-73	Сочи (862)225-72-31
Астрахань (8512)99-46-04	Калуга (4842)92-23-67	Омск (3812)21-46-40	Ставрополь (8652)20-65-13
Барнаул (3852)73-04-60	Кемерово (3842)65-04-62	Орел (4862)44-53-42	Сургут (3462)77-98-35
Белгород (4722)40-23-64	Киров (8332)68-02-04	Оренбург (3532)37-68-04	Тверь (4822)63-31-35
Брянск (4832)59-03-52	Краснодар (861)203-40-90	Пенза (8412)22-31-16	Томск (3822)98-41-53
Владивосток (423)249-28-31	Красноярск (391)204-63-61	Пермь (342)205-81-47	Тула (4872)74-02-29
Волгоград (844)278-03-48	Курск (4712)77-13-04	Ростов-на-Дону (863)308-18-15	Тюмень (3452)66-21-18
Вологда (8172)26-41-59	Липецк (4742)52-20-81	Рязань (4912)46-61-64	Ульяновск (8422)24-23-59
Воронеж (473)204-51-73	Магнитогорск (3519)55-03-13	Самара (846)206-03-16	Уфа (347)229-48-12
Екатеринбург (343)384-55-89	Москва (495)268-04-70	Санкт-Петербург (812)309-46-40	Хабаровск (4212)92-98-04
Иваново (4932)77-34-06	Мурманск (8152)59-64-93	Саратов (845)249-38-78	Челябинск (351)202-03-61
Ижевск (3412)26-03-58	Набережные Челны (8552)20-53-41	Севастополь (8692)22-31-93	Череповец (8202)49-02-64
Иркутск (395)279-98-46	Нижний Новгород (831)429-08-12	Симферополь (3652)67-13-56	Ярославль (4852)69-52-93
Россия (495)268-04-70	Киргизия (996)312-96-26-47	Казахстан (7172)727-132	

Cardiovascular

Forceps



BD710R-BD712R

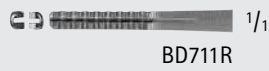
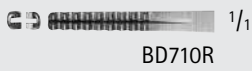

RESANO Cardiac Valve Forceps

Catalog Number	Tip Size (mm)	Length (in.)
BD710R	2.5	7
BD711R	2.5	8
BD712R	2.5	9

FB397R-FB399R

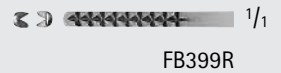
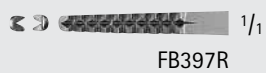

RESANO Cardiac Valve Forceps

Catalog Number	Tip Size (mm)	Length (in.)
FB397R	2	7
FB398R	2	9
FB399R	2	11 3/4



MILLIMETERS

Korn- und Tupferzangen – Sponge- and Dressing Forceps

Arterien- und Gewebefassungen

Artery Traction- and Tissue Grasping Forceps

weitere Gewebefassungen siehe Rubrik EA
further Tissue grasping forceps see section EA

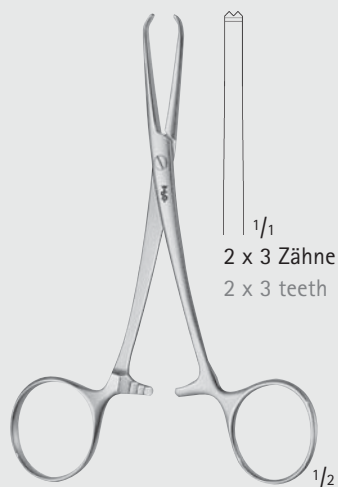

POIRIER

BF299R

125 mm, 5"

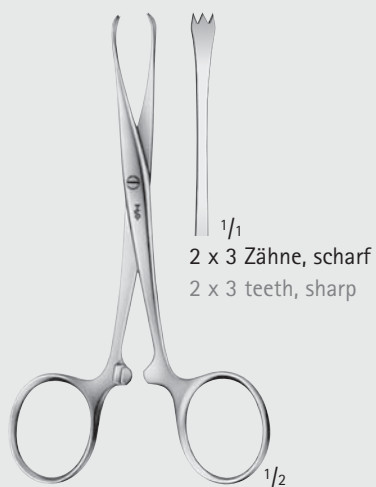

CHAPUT

BF300R

125 mm, 5"

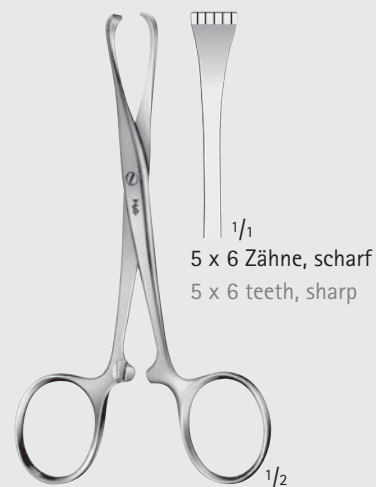

TUFFIER

BF301R

125 mm, 5"



BABY-ALLIS

EA012R

130 mm, 5 1/8"

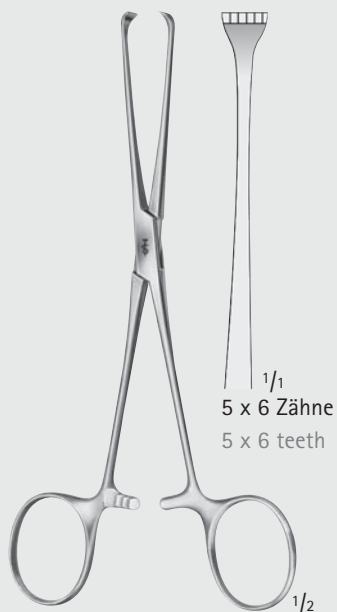

BOYS-ALLIS

EA010R

155 mm, 6"

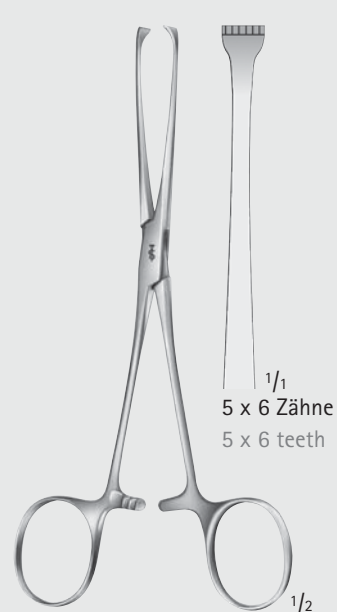

ALLIS

EA016R

155 mm, 6"

BF



Obstetrics/Gynecology

Tenaculum and Sponge Forceps

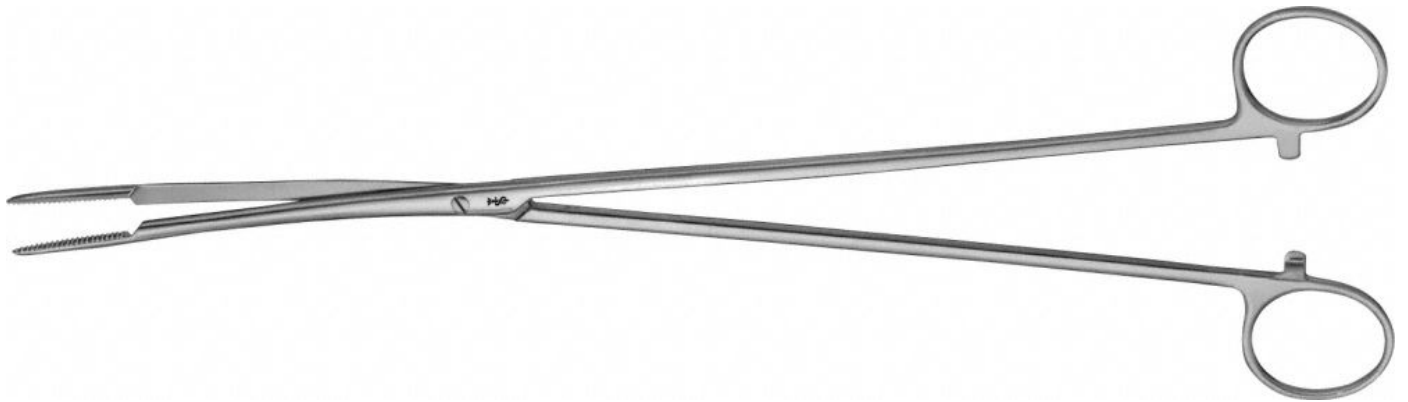
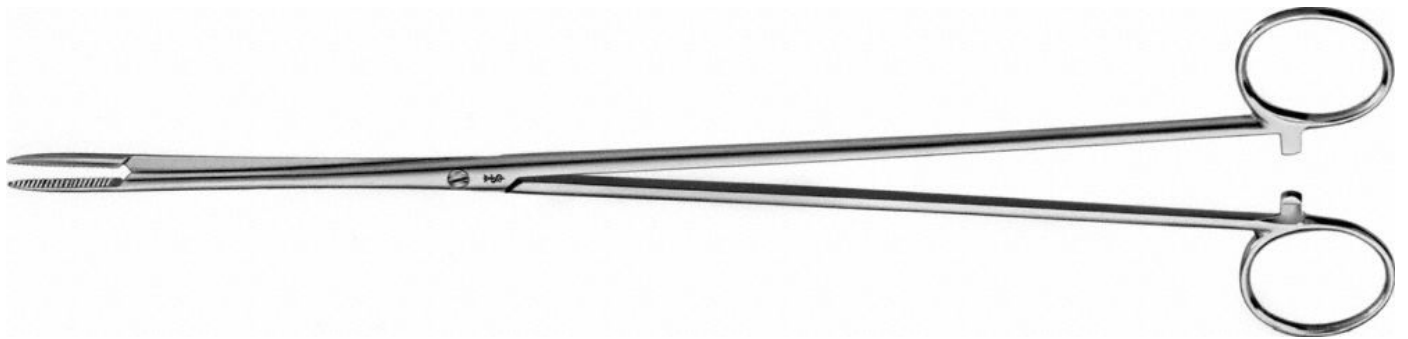

PELKMANN Forceps

Catalog Number	Tip	Jaw	Length (in.)
EO060R	SERR	STR	10 1/4
EO061R	SERR	CVD	10 1/4

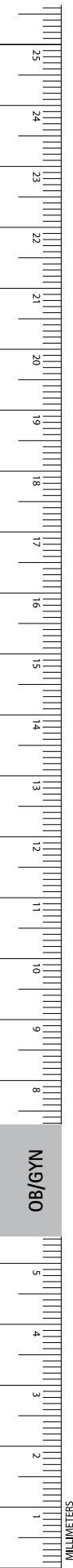
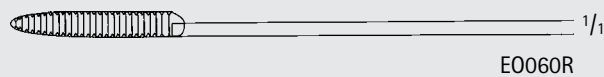
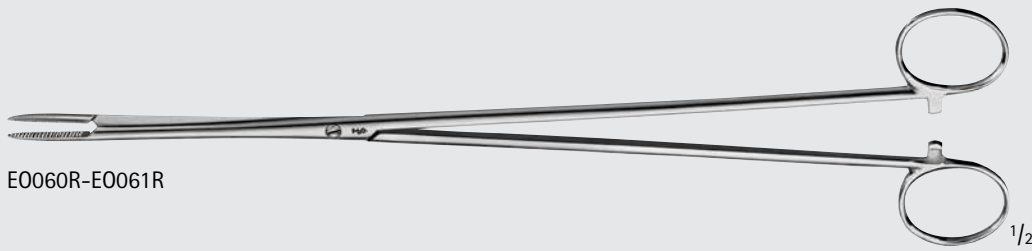

OB/GYN

MILLIMETERS

Korn- und Tupferzangen – Sponge- and Dressing Forceps

Korn- und Tupferzangen
Sponge- and Dressing Forceps

BF

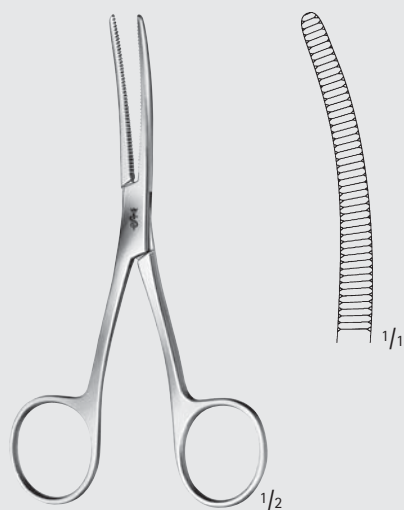

BRYANT

BF003R

130 mm, 5 1/8"



LISTER

BF004R-BF008R

Sinusklemmen
Sinus forceps

BF004R	BF006R	BF008R
130 mm	160 mm	175 mm
5 1/8"	6 1/4"	7"

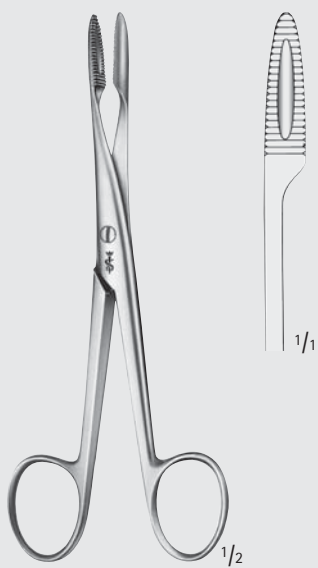

BF010R

ohne Sperre
without ratchet
145 mm, 5 3/4"

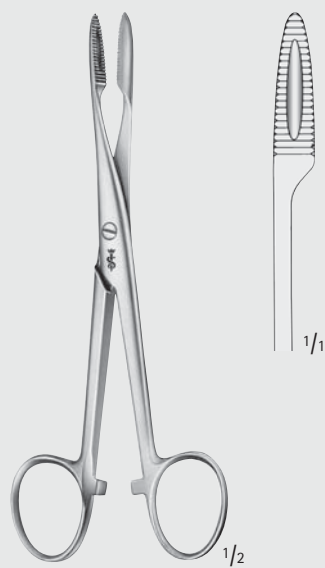

BF016R

mit Sperre
with ratchet
145 mm, 5 3/4"

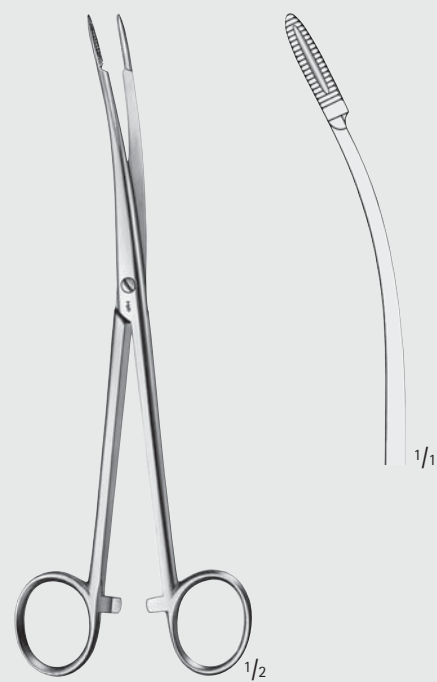

BF021R

175 mm, 7"



Korn- und Tupferzangen – Sponge- and Dressing Forceps

Korn- und Tupferzangen
Sponge- and Dressing Forceps

BF

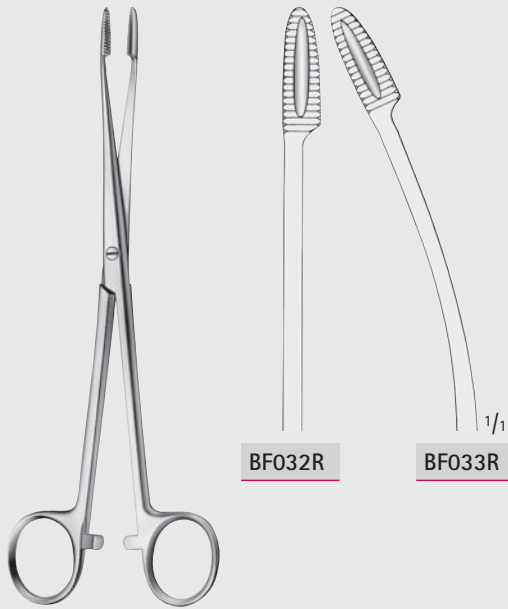

BF032R

BF033R

GROSS

BF032R-BF033R

mit Sperre
with ratchet
180 mm, 7"

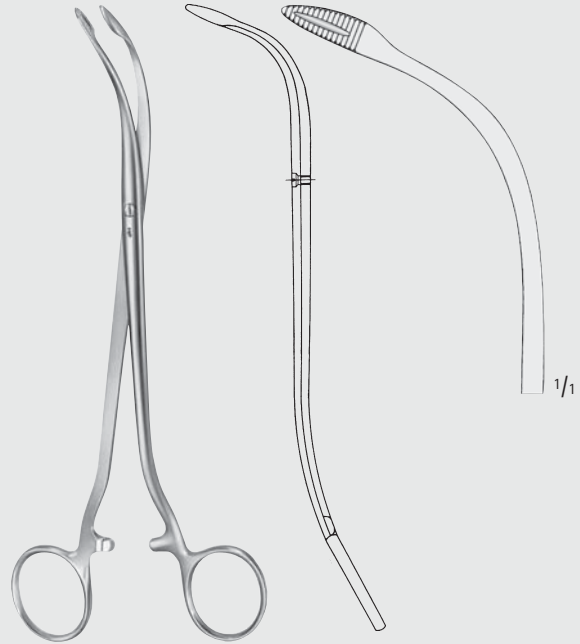

DUPLAY

OM485R

190 mm, 7 1/2"

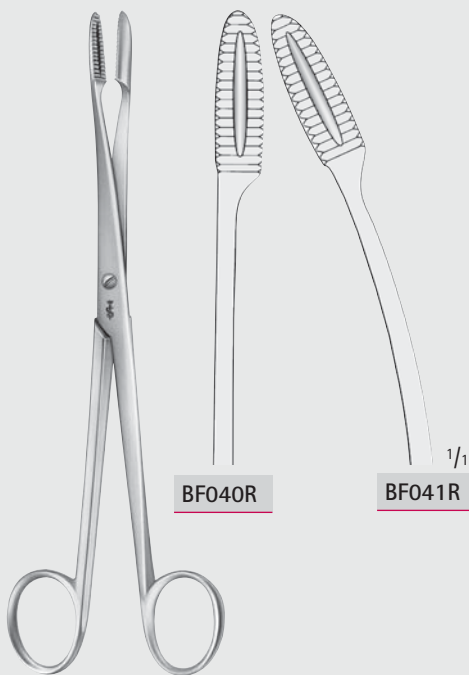

BF040R

BF041R

GROSS

BF040R-BF041R

ohne Sperre
without ratchet
200 mm, 8"

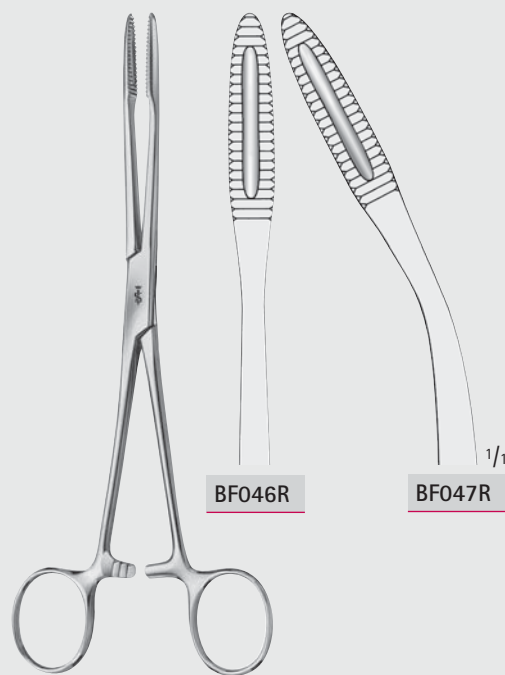

BF046R

BF047R

GROSS

BF046R-BF047R

200 mm, 8"

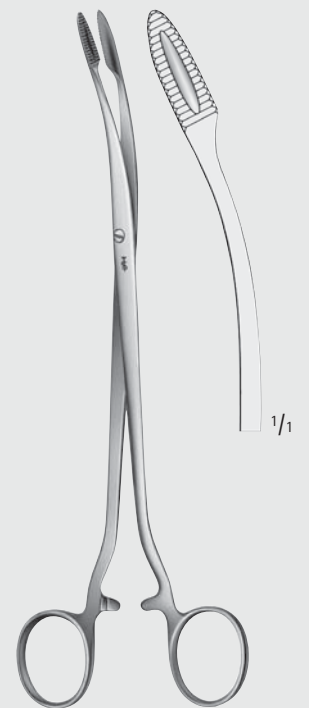

DUPLAY

BF027R

210 mm, 8 1/4"

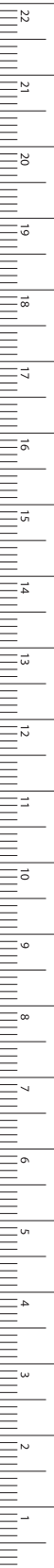

MILLIMETERS

Korn- und Tupferzangen – Sponge- and Dressing Forceps

Korn-, Tupfer- und Waschzangen

Sponge- and Dressing Forceps

BF



BF060R

BF061R

AESCULAP

BF060R-BF061R

220 mm, 8 3/4"



BF062R

265 mm

10 1/2"

BF063R

265 mm

10 1/2"

BF065R

350 mm

14"

ULRICH-AESCULAP

BF062R-BF065R



Korn- und Tupferzangen – Sponge- and Dressing Forceps

Korn- und Tupferzangen
Sponge- and Dressing Forceps

BF

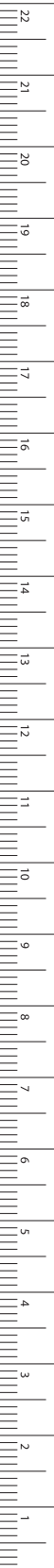

MILLIMETERS

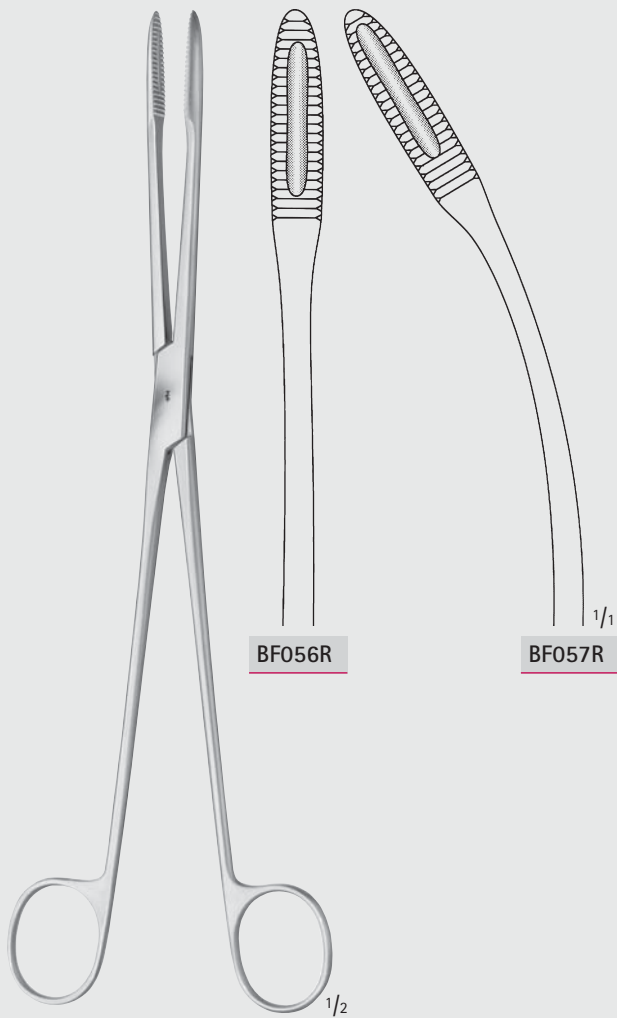

BF056R

BF057R

MAIER

BF056R-BF057R

ohne Sperre
without ratchet
265 mm, 10 1/2"

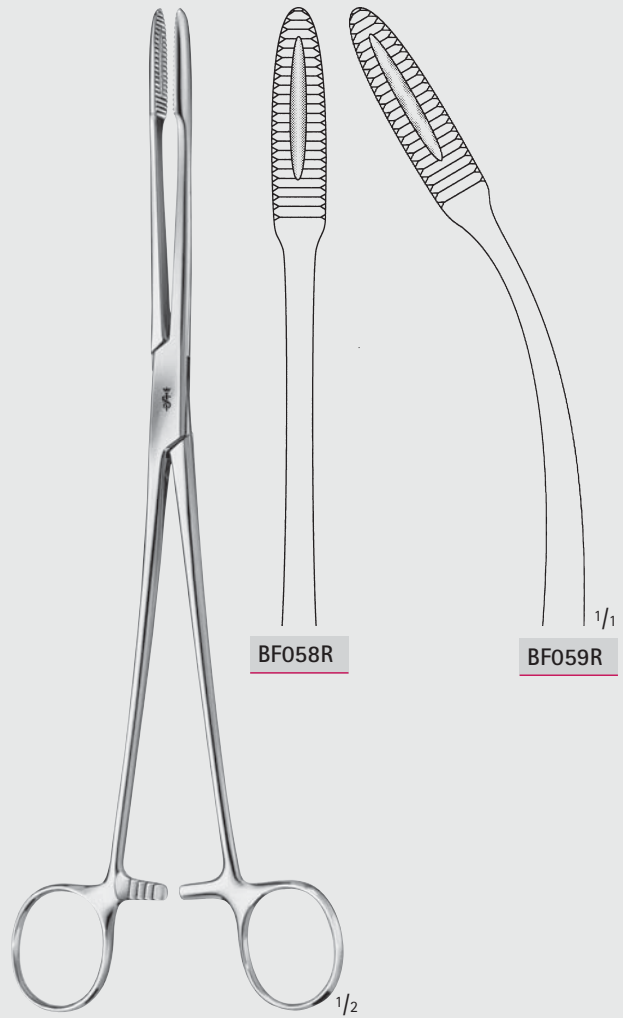

BF058R

BF059R

MAIER

BF058R-BF059R

mit Sperre
with ratchet
265 mm, 10 1/2"

Korn- und Tupferzangen – Sponge- and Dressing Forceps

Korn- und Tupferzangen
Sponge- and Dressing Forceps

BF

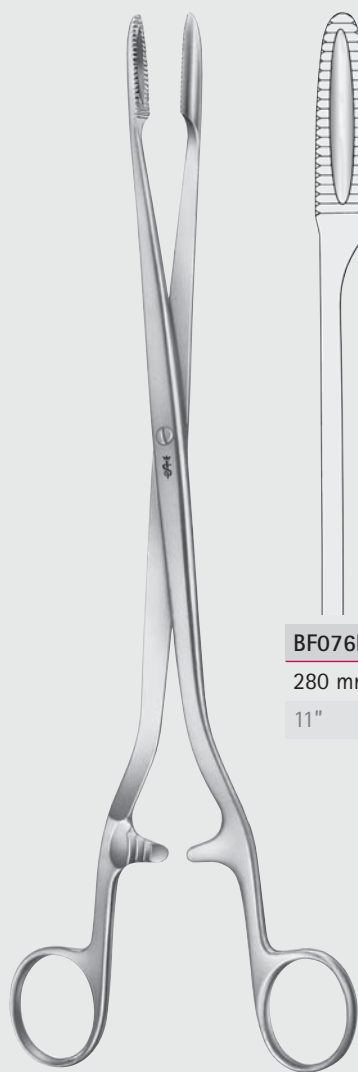
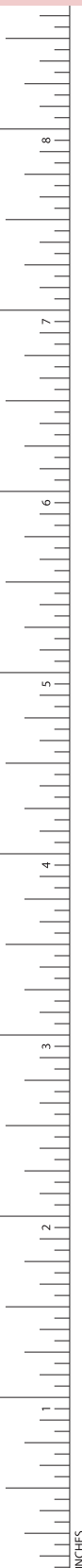

SIMS-MAIER

BF076R-BF078R

BF076R
280 mm
11"

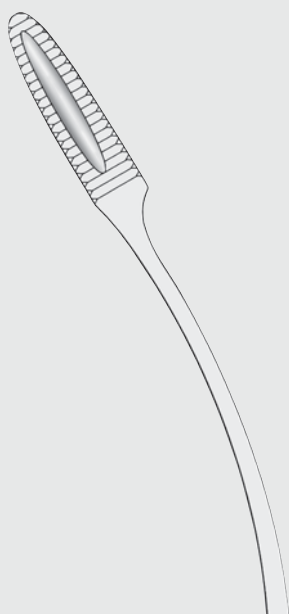

BF077R
280 mm
11"



BF078R
350 mm
14"

1/1



BF070R-BF071R

240 mm, 9 1/2"

BF070R



BF071R

1/1

1/2



Korn- und Tupferzangen – Sponge- and Dressing Forceps

Korn- und Tupferzangen
Sponge- and Dressing Forceps

BF

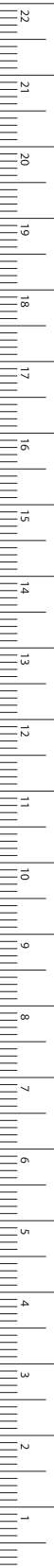

MILLIMETERS



BF091R

COLLIN

BF091R

240 mm, 9 1/2"

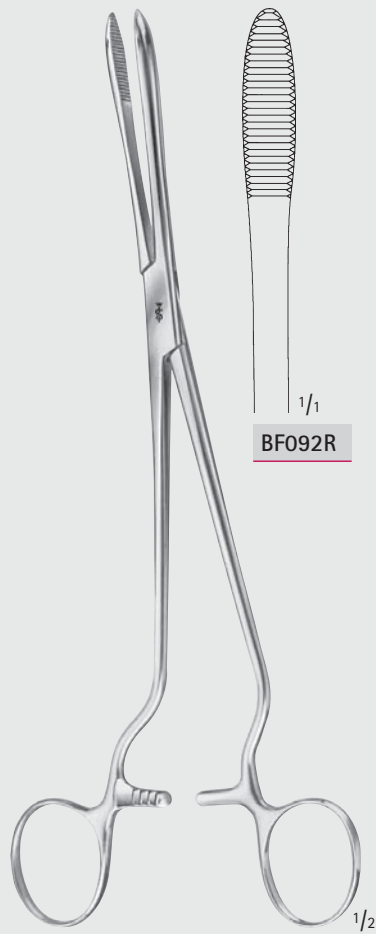

BF092R

CHERON

BF092R

Griffe seitwärts abgewinkelt
Handles angled to side
240 mm, 9 1/2"

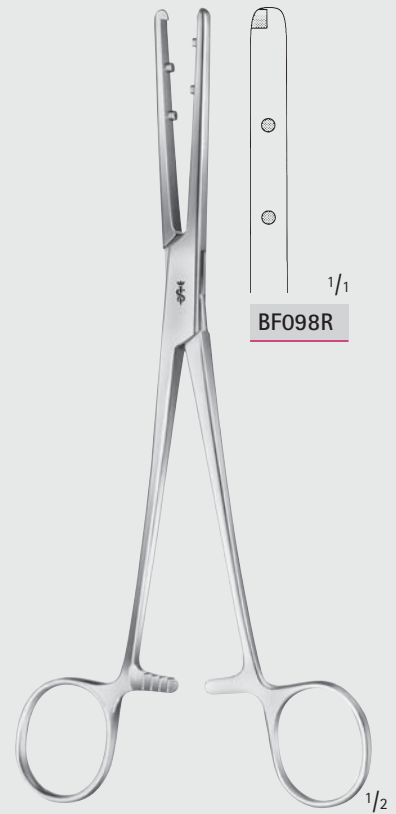

BF098R

EMMET

BF098R

210 mm, 8 1/4"



Korn- und Tupferzangen – Sponge- and Dressing Forceps Organ- und Gewebefasszangen Organ- and Tissue Grasping Forceps

BF

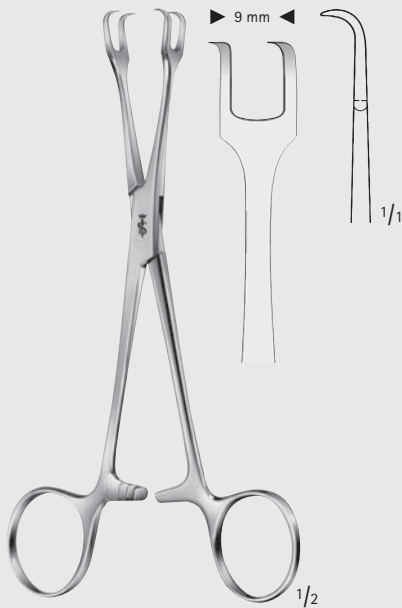

LAHEY

BF309R

155 mm, 6"

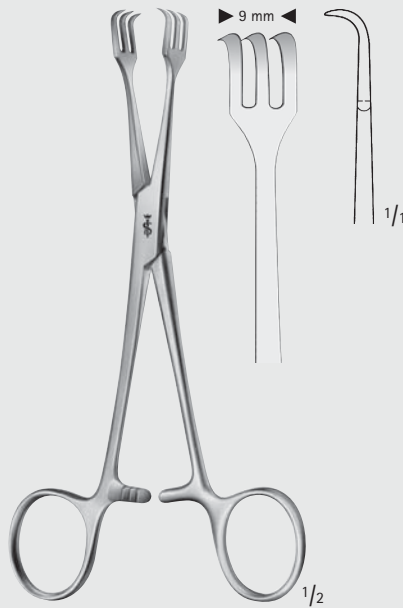

LAHEY

BF310R

155 mm, 6"

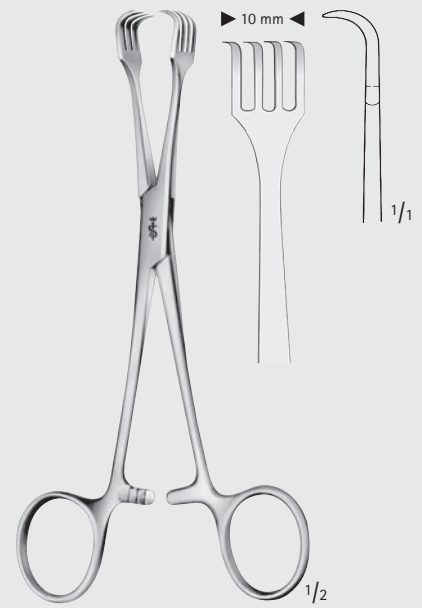

BRAUN

BF311R

155 mm, 6"

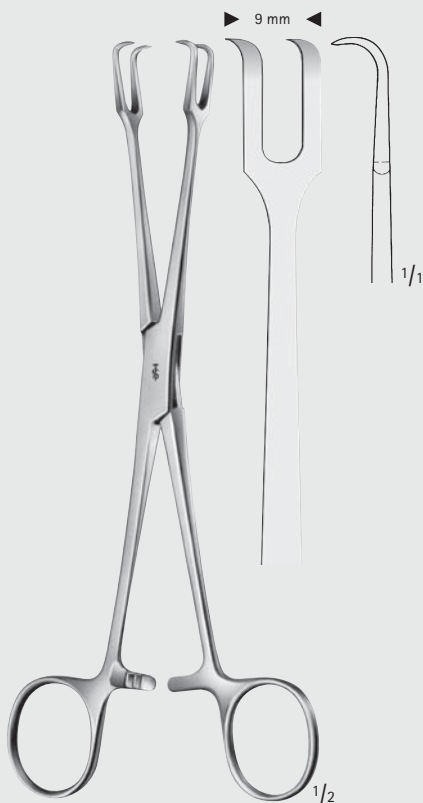

MUSEUX

OM602R

200 mm, 8"

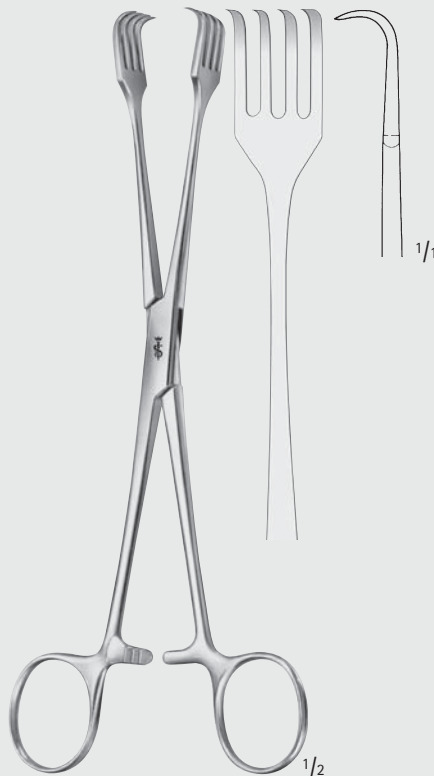

CZERNY

E0164R

200 mm, 8"



SCHRÖDER

E0163R

270 mm, 10 3/4"



MILLIMETERS

Korn- und Tupferzangen – Sponge- and Dressing Forceps
Organ- und Gewebefasszangen
Organ- and Tissue Grasping Forceps

BF

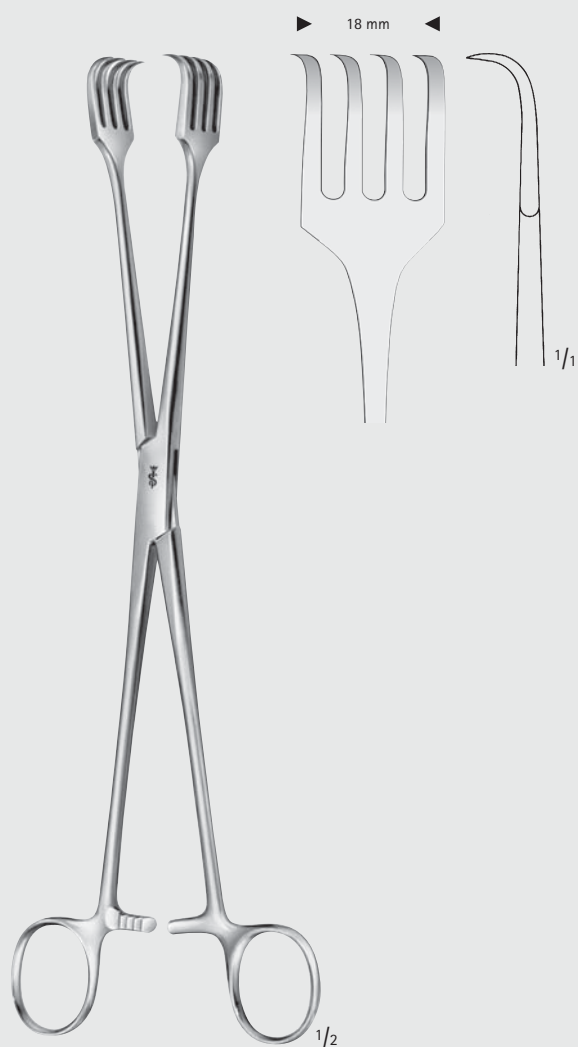

AESCULAP-PRATT

EO165R

260 mm, 10 1/4"

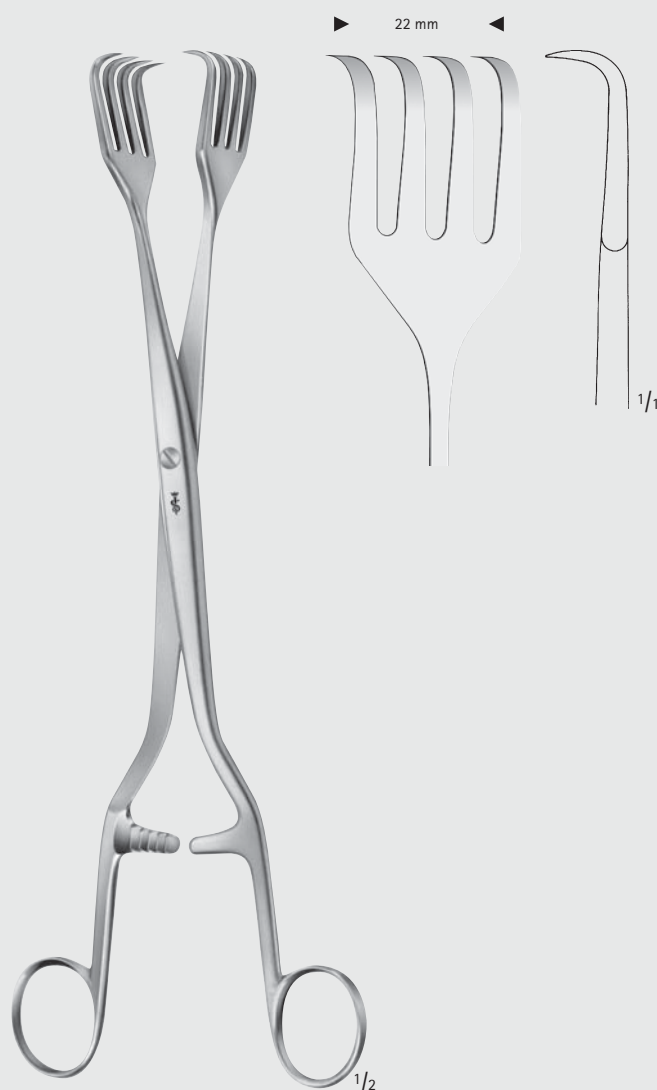

PRATT

EO166R

270 mm, 10 3/4"



Korn- und Tupferzangen – Sponge- and Dressing Forceps
Organ- und Gewebefasszangen
Organ- and Tissue Grasping Forceps

BF

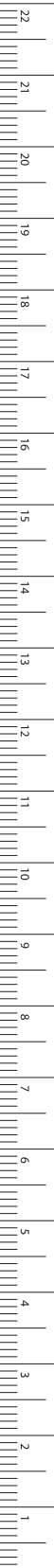

MILLIMETERS

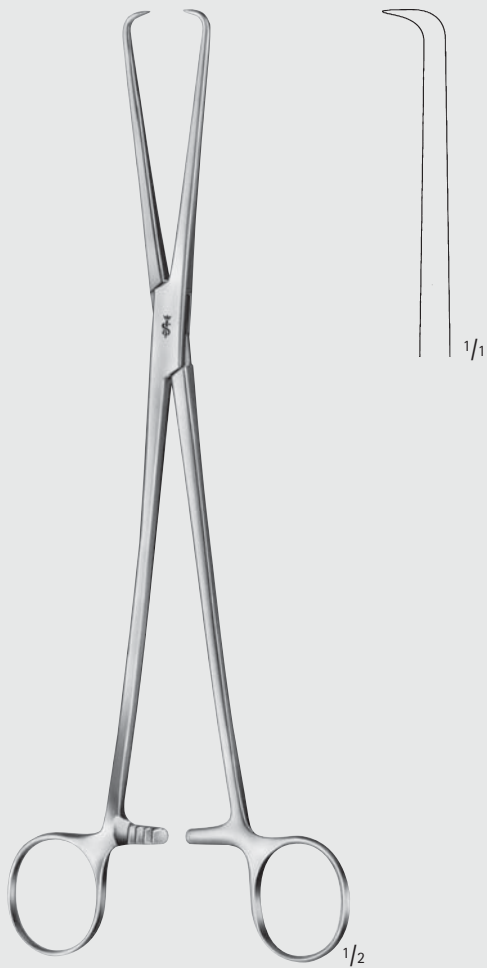

SCHRÖDER

E0110R

250 mm, 10"

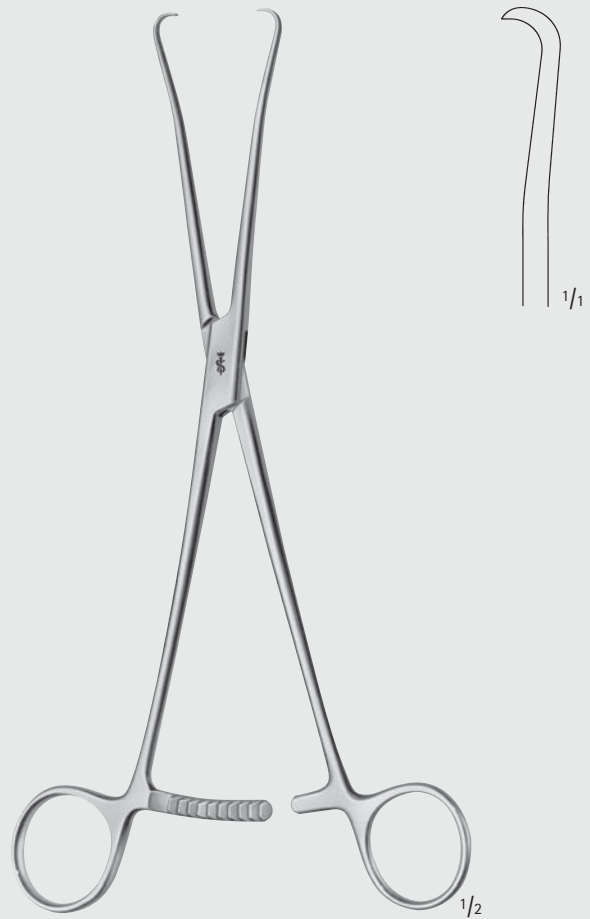

WILSON

E0112R

240 mm, 9 1/2"

Abdominale Chirurgie – Abdominal Surgery

Organ- und Gewebefasszangen

Organ- and Tissue Grasping Forceps

EA



JUDD-ALLIS

EA025R

155 mm, 6"



JUDD-ALLIS

EA026R

195 mm, 7 3/4"

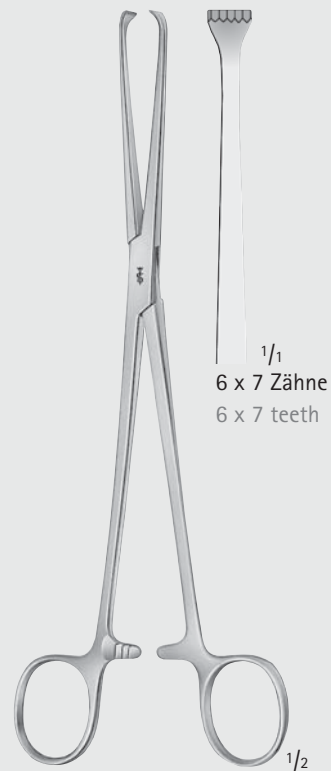

ALLIS-THOMS

EA020R

200 mm, 8"

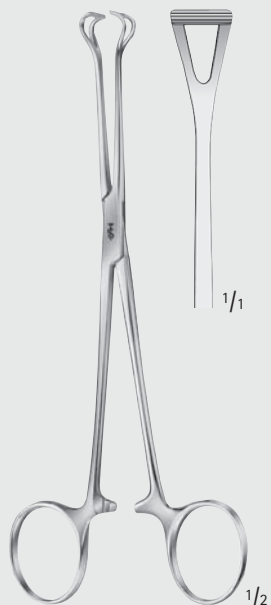

BABCOCK

EA030R

155 mm, 6"



BABCOCK

EA031R-EA033R

EA031R	EA032R	EA033R
170 mm	215 mm	200 mm
6 3/4"	8 1/2"	8"



BABCOCK

FB934R

220 mm, 8 3/4"



Abdominale Chirurgie – Abdominal Surgery
 Darmfazzangen
 Intestinal Grasping Forceps

EA

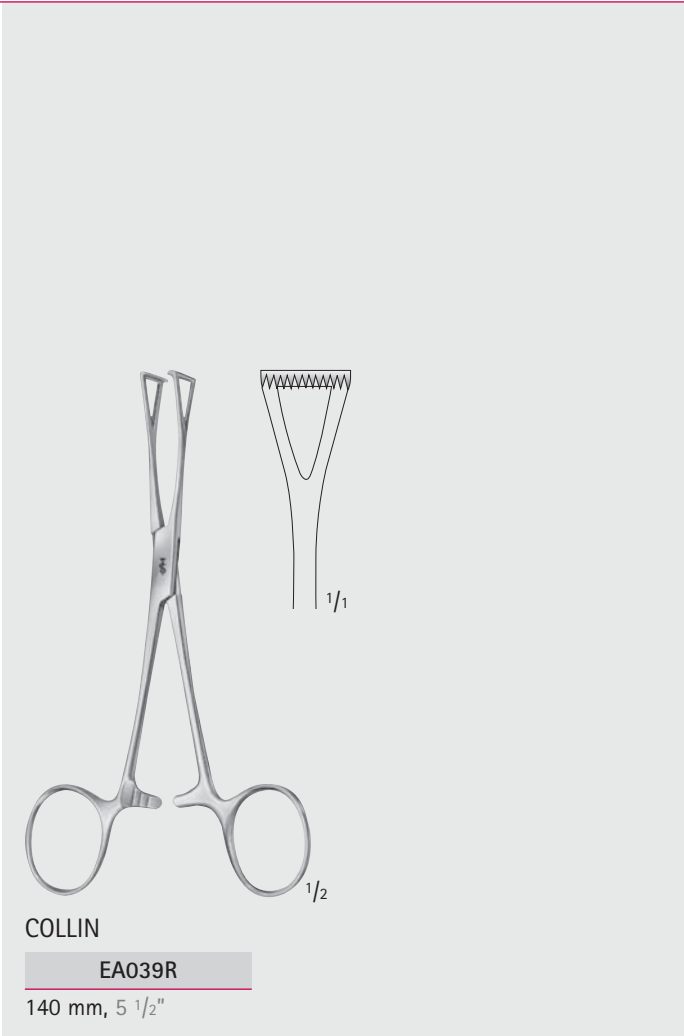

COLLIN
EA039R
 140 mm, 5 1/2"

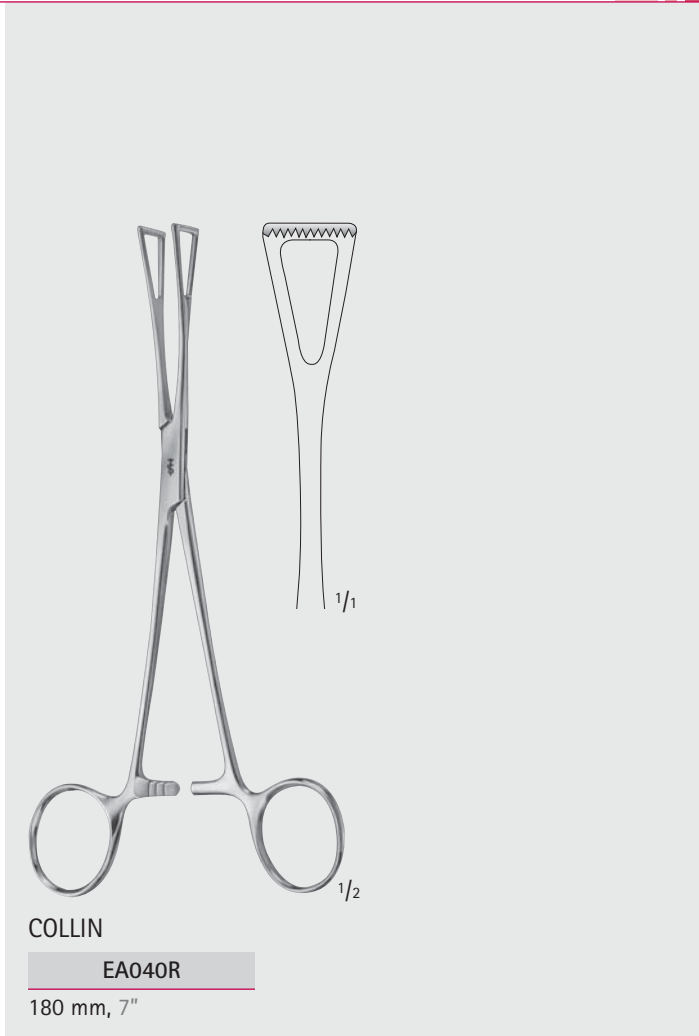

COLLIN
EA040R
 180 mm, 7"

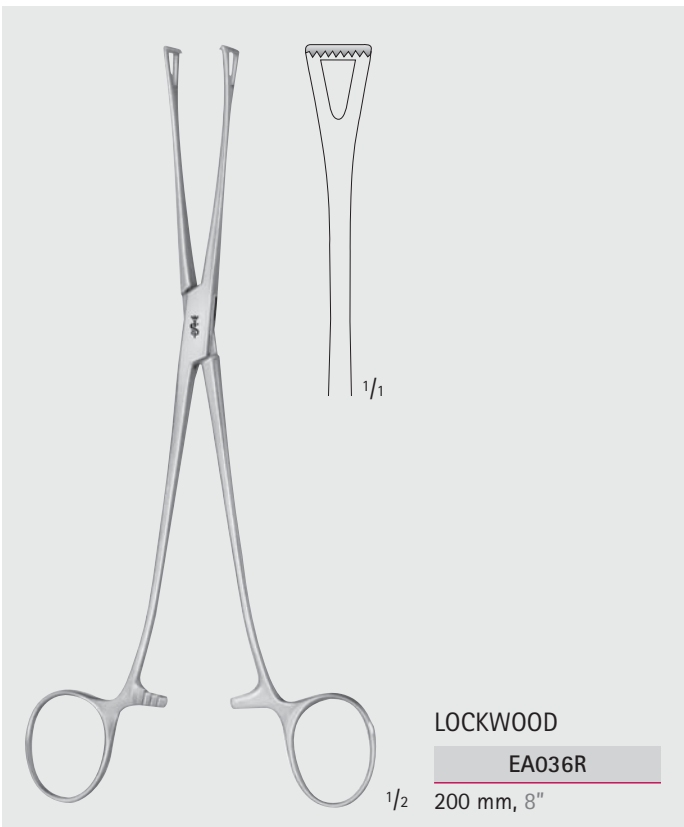

LOCKWOOD
EA036R
 200 mm, 8"

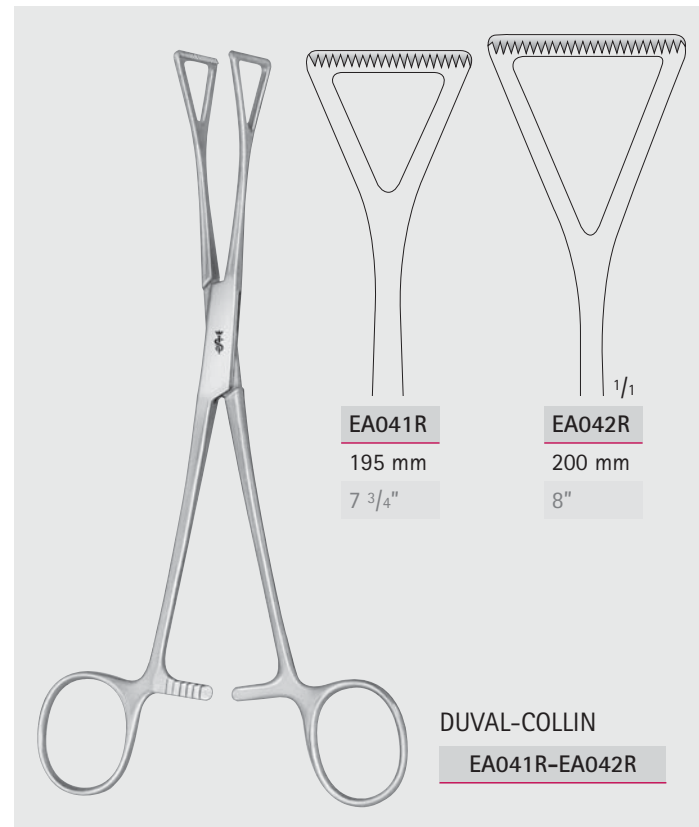

EA041R
 195 mm
 7 3/4"

EA042R
 200 mm
 8"

DUVAL-COLLIN
EA041R-EA042R

Abdominale Chirurgie – Abdominal Surgery

Darmfazzangen

Intestinal Grasping Forceps

EA

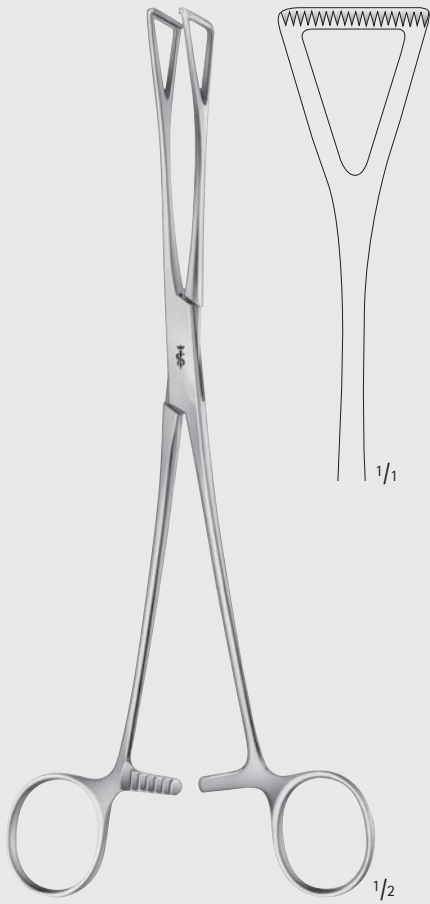

DUVAL

FB930R

230 mm, 9"

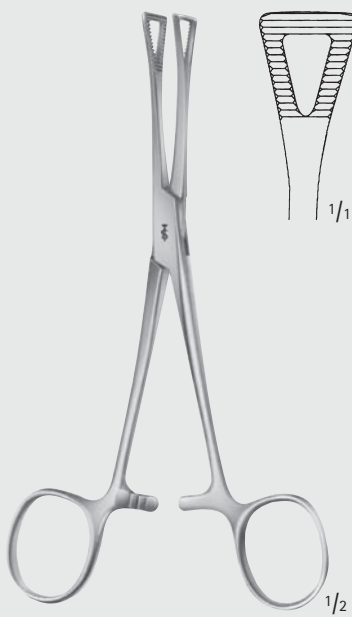

PENNINGTON

BH902R

155 mm, 6"



PENNINGTON

EA037R

200 mm, 8"

INCHES

Plastic Surgery

Bone and Tendon Forceps

HERZ Tendon Seizing Forceps

Catalog Number	Jaw	Length (in.)
BF303R	CVD	6 1/8

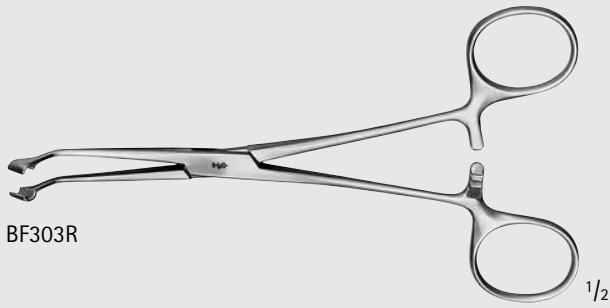

JACKSON Tendon Seizing Forceps

Catalog Number	Teeth	Length (in.)
BF306R	4 x 5	6 1/8

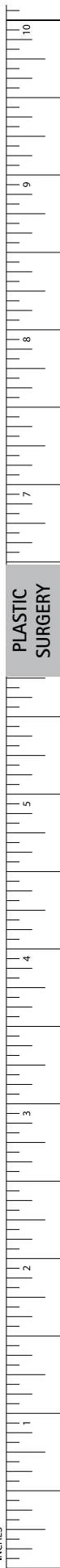
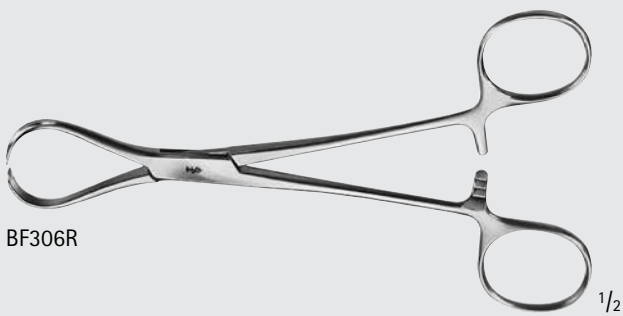

Plastic Surgery

Bone and Tendon Forceps

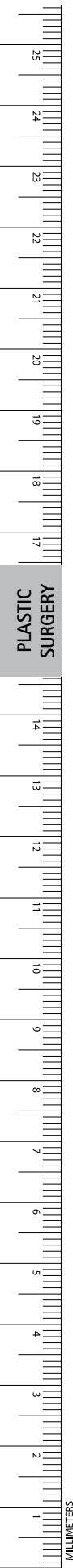

BF307R

1/2

1/1

1/1

BF307R

Tendon Seizing Forceps, W/ 3 Pins

Catalog Number	Length (in.)
BF307R	4 3/4

BF324R

1/1

BF324R

BF326R

1/1

BF326R

BF315R

1/2

1/1

BF315R

BF316R

1/1

BF316R

BRAND Tendon Holding Forceps

Catalog Number	Jaw	Teeth	Length (in.)
BF324R	STR	1 x 2	6
BF326R	STR	1 x 2	7 1/4
BF315R	CVD	1 x 2	6
BF316R	CVD	1 x 2	7 1/4

PLASTIC SURGERY

MILLIMETERS

Plastic Surgery

Bone and Tendon Forceps

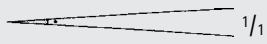
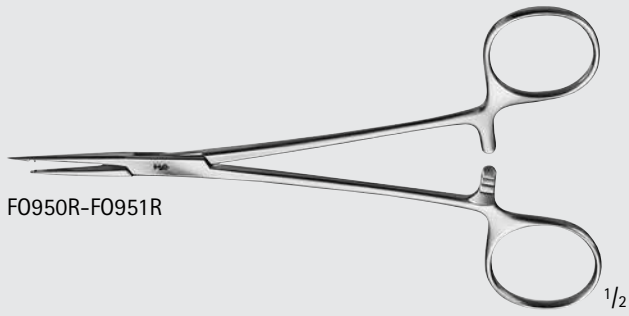

F0950R

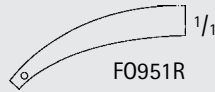

F0951R

Tendon Interlacing Forceps

Catalog Number	Jaw	Length (in.)
F0950R	STR	6
F0951R	CVD	6

PLASTIC SURGERY

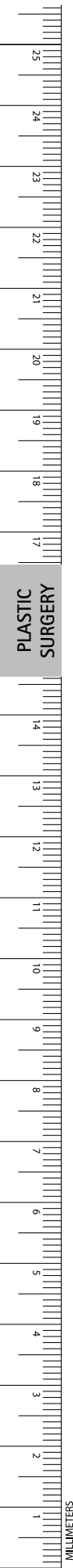

Clips, Clamps – Clips, Klemmen

Organ and Tissue Grasping Forceps

Organ- und Gewebefasszangen

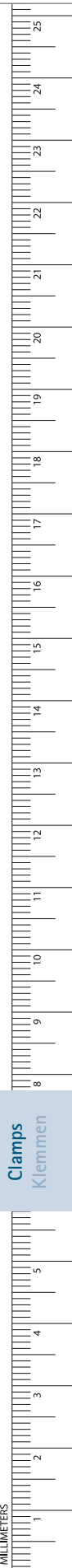
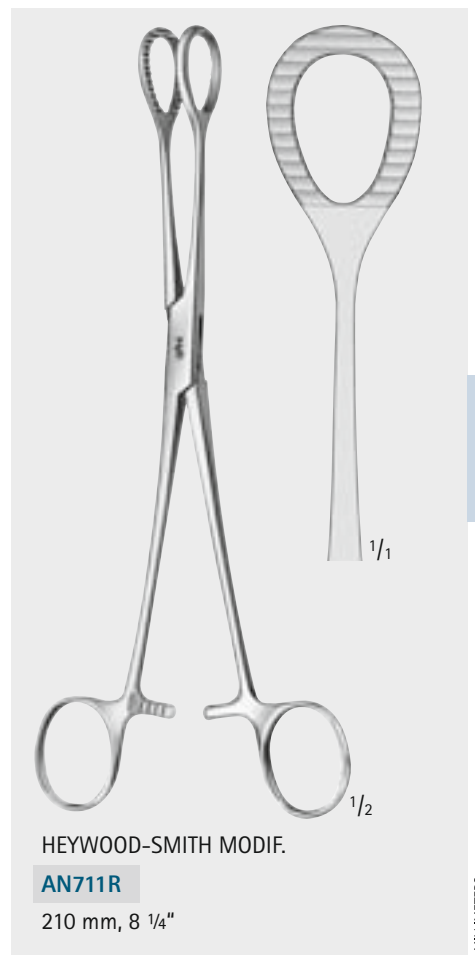
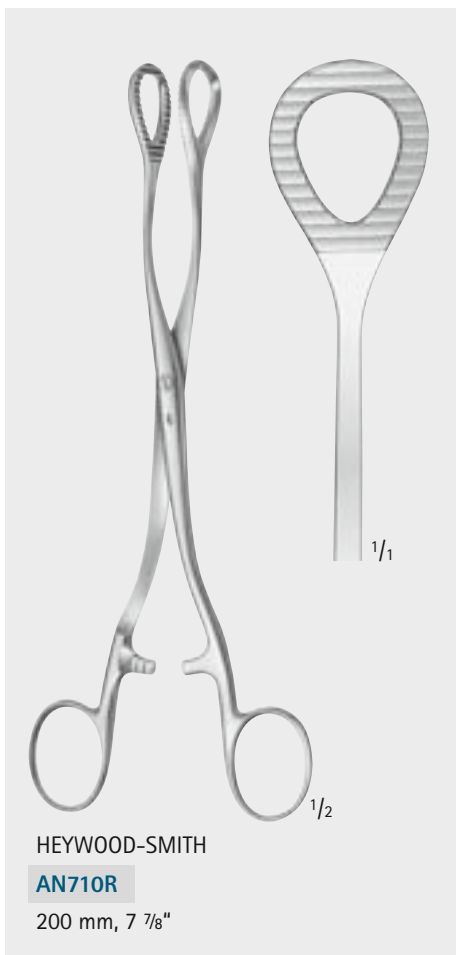
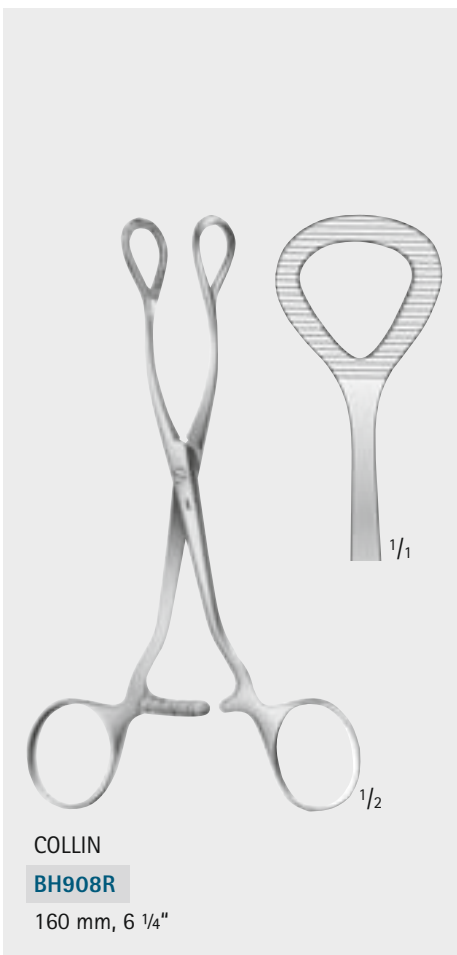
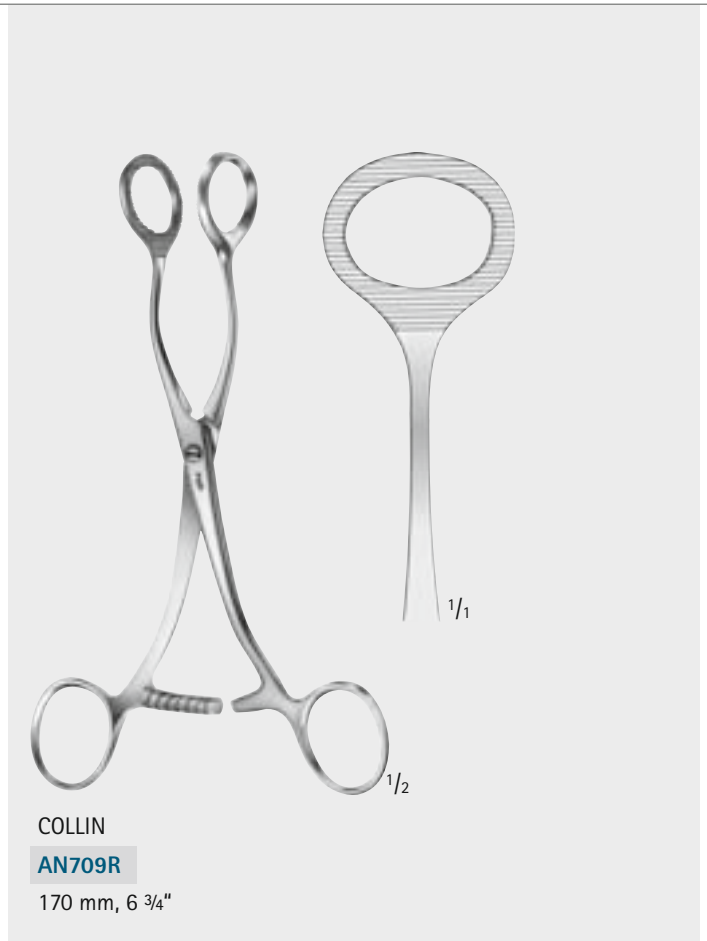
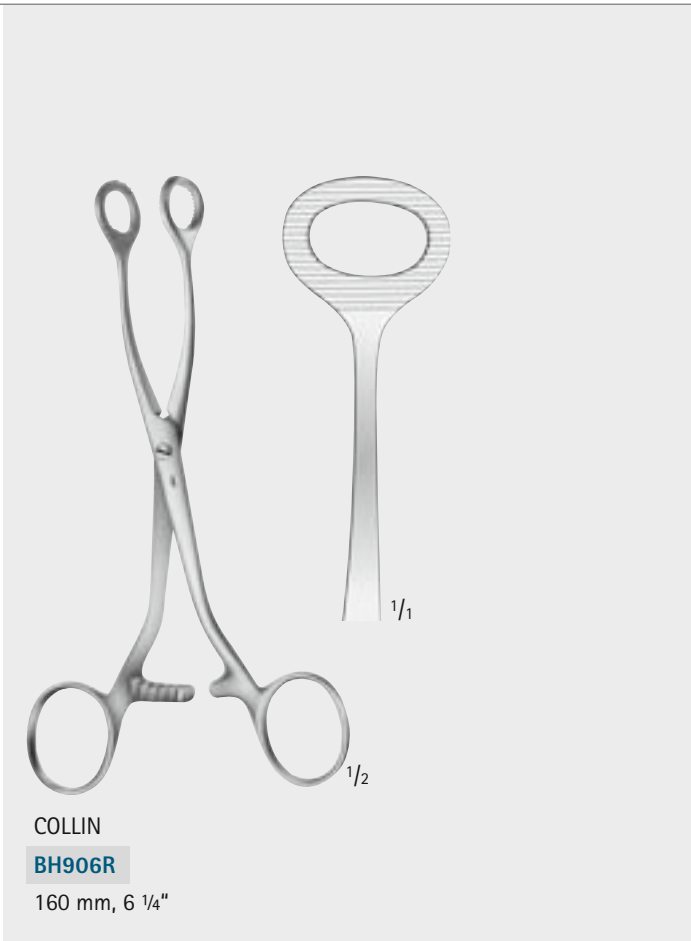

General Surgery

Dressing and Tissue Forceps



BD755R

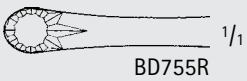

BD755R



BD760R-BD761R, MB921R-MB922R, XG006R

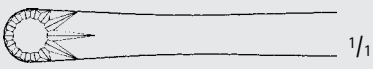

BD760R



BD761R, MB921R, MB922R

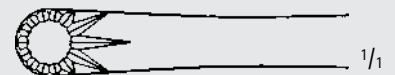

XG006R

RUSSIAN Tissue Forceps

Catalog Number	Length (in.)
BD755R	6
BD760R	7 7/8
XG006R	9 3/4
BD761R	10 1/4
MB921R	12
MB922R	14

Korn- und Tupferzangen – Sponge- and Dressing Forceps

Tupfer-, Schwamm-, Organ- und Gewebefasszangen

Dressing-, Sponge Holding-, Organ- and Tissue Grasping Forceps

BF



FOERSTER-BALLENGER

BF112R-BF113R

180 mm, 7"

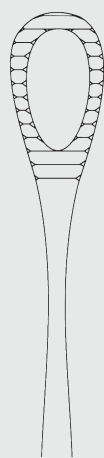

BF112R

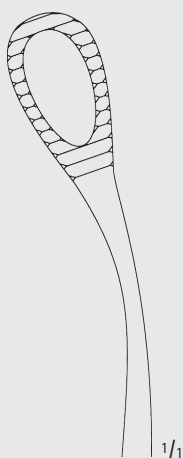

BF113R



RAMPLEY

BF116R-BF118R

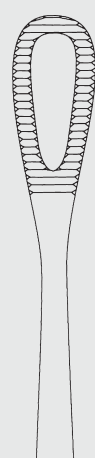

BF116R

180 mm
7"



BF118R

250 mm
10"



FOERSTER-BALLENGER

BF120R-BF123R

245 mm, 9 3/4"



BF120R

glattes Maul
smooth jaws



BF121R

glattes Maul
smooth jaws

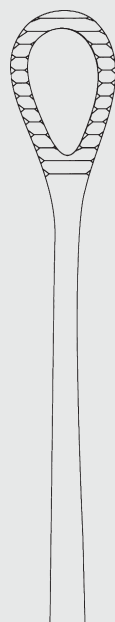

BF122R

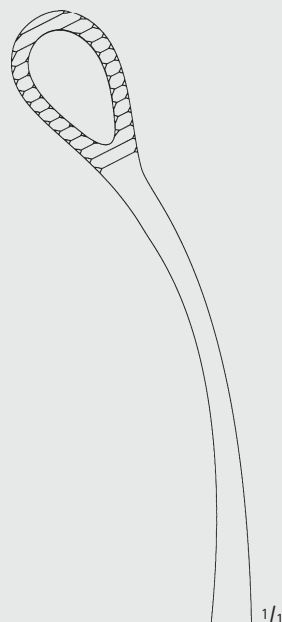

BF123R



Korn- und Tupferzangen – Sponge- and Dressing Forceps

Tupfer-, Schwamm-, Organ- und Gewebefasszangen
Dressing-, Sponge Holding-, Organ- and Tissue Grasping Forceps

BF



E0310R

HEYWOOD-SMITH

E0310R

250 mm, 10"

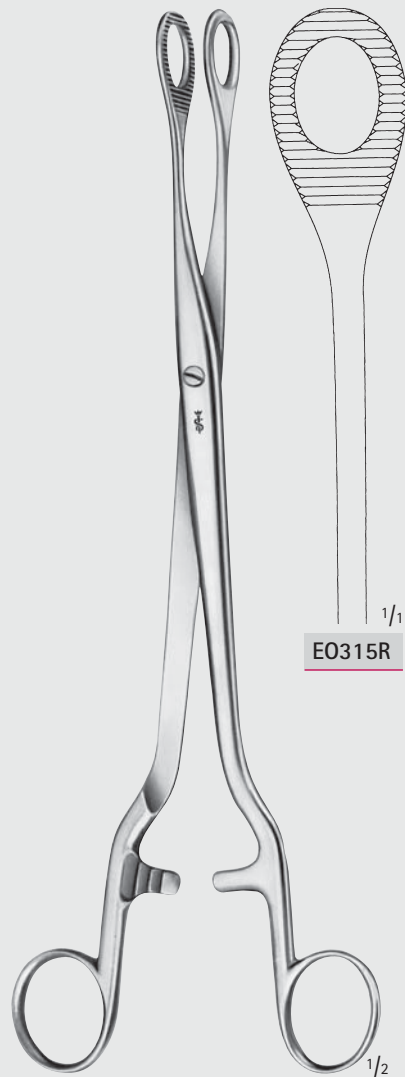

E0315R

NOTO

E0315R

280 mm, 11"

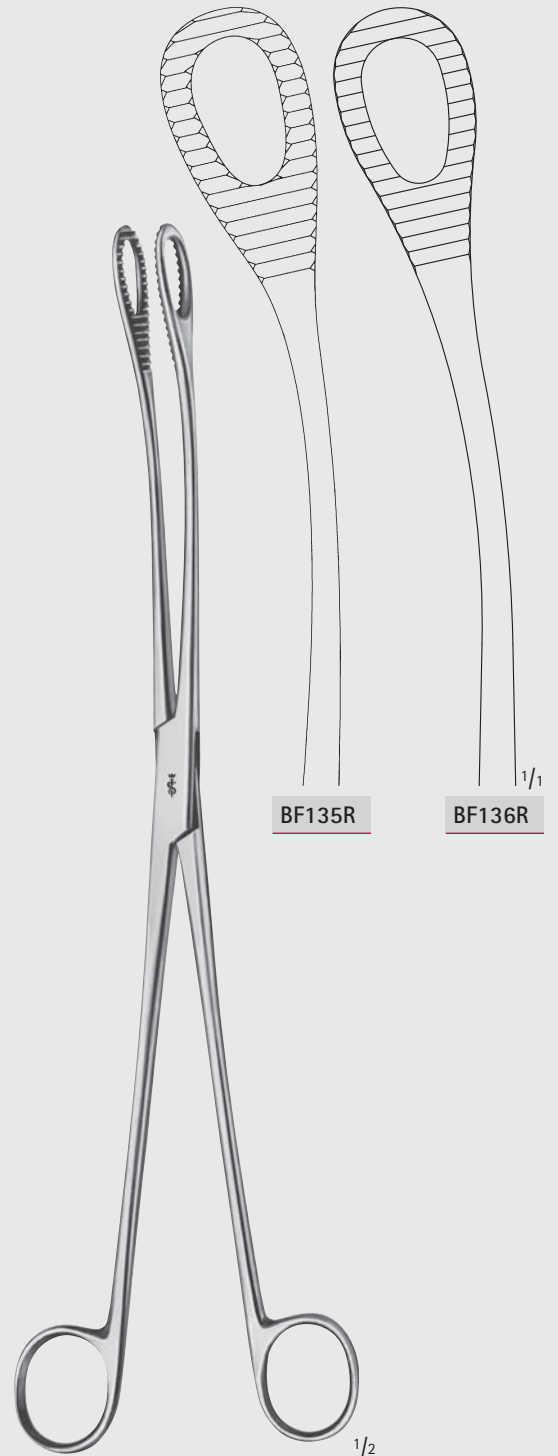

BF135R

BF136R

KELLY

BF135R-BF136R

320 mm, 12 3/4"



MILLIMETERS

По вопросам продаж и поддержки обращайтесь:

Алматы (7273)495-231	Казань (843)206-01-48	Новокузнецк (3843)20-46-81	Смоленск (4812)29-41-54
Архангельск (8182)63-90-72	Калининград (4012)72-03-81	Новосибирск (383)227-86-73	Сочи (862)225-72-31
Астрахань (8512)99-46-04	Калуга (4842)92-23-67	Омск (3812)21-46-40	Ставрополь (8652)20-65-13
Барнаул (3852)73-04-60	Кемерово (3842)65-04-62	Орел (4862)44-53-42	Сургут (3462)77-98-35
Белгород (4722)40-23-64	Киров (8332)68-02-04	Оренбург (3532)37-68-04	Тверь (4822)63-31-35
Брянск (4832)59-03-52	Краснодар (861)203-40-90	Пенза (8412)22-31-16	Томск (3822)98-41-53
Владивосток (423)249-28-31	Красноярск (391)204-63-61	Пермь (342)205-81-47	Тула (4872)74-02-29
Волгоград (844)278-03-48	Курск (4712)77-13-04	Ростов-на-Дону (863)308-18-15	Тюмень (3452)66-21-18
Вологда (8172)26-41-59	Липецк (4742)52-20-81	Рязань (4912)46-61-64	Ульяновск (8422)24-23-59
Воронеж (473)204-51-73	Магнитогорск (3519)55-03-13	Самара (846)206-03-16	Уфа (347)229-48-12
Екатеринбург (343)384-55-89	Москва (495)268-04-70	Санкт-Петербург (812)309-46-40	Хабаровск (4212)92-98-04
Иваново (4932)77-34-06	Мурманск (8152)59-64-93	Саратов (845)249-38-78	Челябинск (351)202-03-61
Ижевск (3412)26-03-58	Набережные Челны (8552)20-53-41	Севастополь (8692)22-31-93	Череповец (8202)49-02-64
Иркутск (395)279-98-46	Нижний Новгород (831)429-08-12	Симферополь (3652)67-13-56	Ярославль (4852)69-52-93
Россия (495)268-04-70	Киргизия (996)312-96-26-47	Казахстан (7172)727-132	