

# Технические характеристики

## По вопросам продаж и поддержки обращайтесь:

Алматы (7273)495-231	Казань (843)206-01-48	Новокузнецк (3843)20-46-81	Смоленск (4812)29-41-54
Архангельск (8182)63-90-72	Калининград (4012)72-03-81	Новосибирск (383)227-86-73	Сочи (862)225-72-31
Астрахань (8512)99-46-04	Калуга (4842)92-23-67	Омск (3812)21-46-40	Ставрополь (8652)20-65-13
Барнаул (3852)73-04-60	Кемерово (3842)65-04-62	Орел (4862)44-53-42	Сургут (3462)77-98-35
Белгород (4722)40-23-64	Киров (8332)68-02-04	Оренбург (3532)37-68-04	Тверь (4822)63-31-35
Брянск (4832)59-03-52	Краснодар (861)203-40-90	Пенза (8412)22-31-16	Томск (3822)98-41-53
Владивосток (423)249-28-31	Красноярск (391)204-63-61	Пермь (342)205-81-47	Тула (4872)74-02-29
Волгоград (844)278-03-48	Курск (4712)77-13-04	Ростов-на-Дону (863)308-18-15	Тюмень (3452)66-21-18
Вологда (8172)26-41-59	Липецк (4742)52-20-81	Рязань (4912)46-61-64	Ульяновск (8422)24-23-59
Воронеж (473)204-51-73	Магнитогорск (3519)55-03-13	Самара (846)206-03-16	Уфа (347)229-48-12
Екатеринбург (343)384-55-89	Москва (495)268-04-70	Санкт-Петербург (812)309-46-40	Хабаровск (4212)92-98-04
Иваново (4932)77-34-06	Мурманск (8152)59-64-93	Саратов (845)249-38-78	Челябинск (351)202-03-61
Ижевск (3412)26-03-58	Набережные Челны (8552)20-53-41	Севастополь (8692)22-31-93	Череповец (8202)49-02-64
Иркутск (395)279-98-46	Нижний Новгород (831)429-08-12	Симферополь (3652)67-13-56	Ярославль (4852)69-52-93
Россия (495)268-04-70	Киргизия (996)312-96-26-47	Казахстан (7172)727-132	



## Abdominale Chirurgie – Abdominal Surgery

Analsonden  
Rectal Probes

EA



### LOCKHART-MUMMERY

**BN021R-BN024R**

Fistelsonden

Fistula probes

165 mm, 6 1/2"

<b>BN021R</b>	Nr. 1	gerade	No. 1	straight
<b>BN022R</b>	Nr. 2	45° gebogen	No. 2	45° curved
<b>BN023R</b>	Nr. 3	90° gebogen	No. 3	90° curved
<b>BN024R</b>	Nr. 4	retrograd gebogen	No. 4	retrograde curved

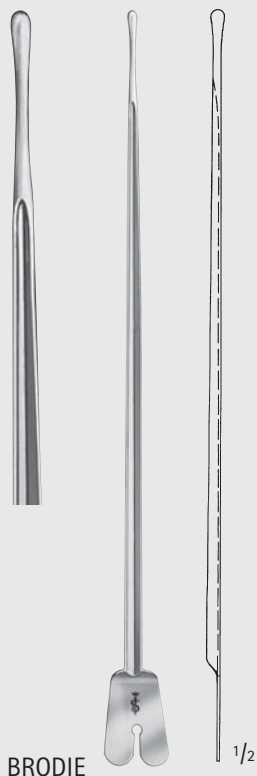

### BRODIE

**BN020R**

Hohlsonde mit Knopf,  
Knopf-Ø: 3,5 mm  
Director with tip,  
diam. of tip: 3.5 mm  
200 mm, 8"

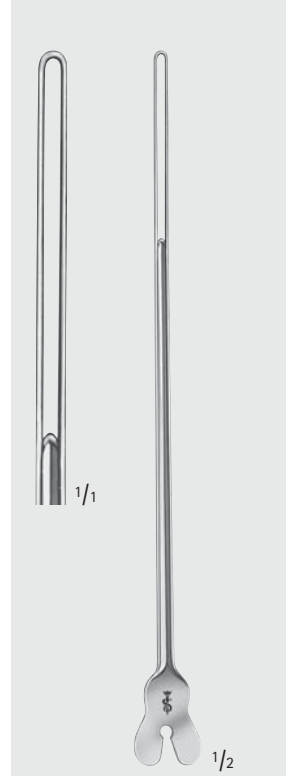

**BN026R**

Ösenrinnensonde,  
biegsam  
Director with wire loop,  
malleable  
190 mm, 7 1/2"

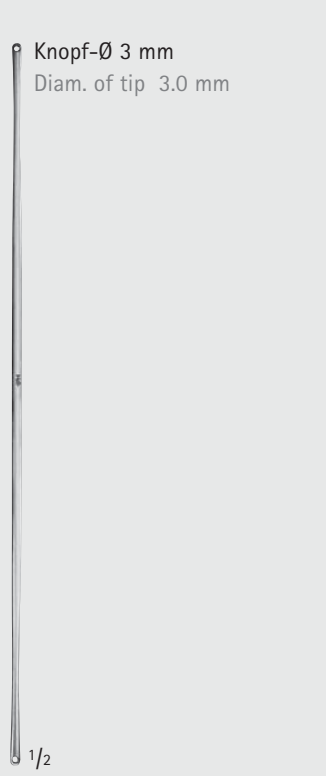

**BN090R**

Doppelknopfsonde,  
biegsam, mit Loch  
Double ended probe,  
malleable, with hole  
190 mm, 7 1/2"

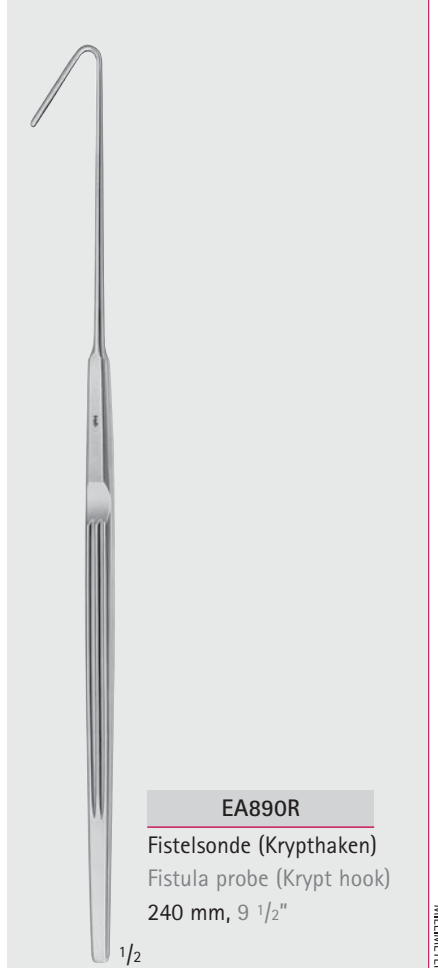

**EA890R**

Fistelsonde (Kryptthaken)  
Fistula probe (Krypt hook)  
240 mm, 9 1/2"



MILLIMETERS

# Abdominale Chirurgie – Abdominal Surgery

## Anal spreizer Rectal Spreader



KUGELSCHNELLVERSCHLUSS  
BALL SNAP CLOSURE

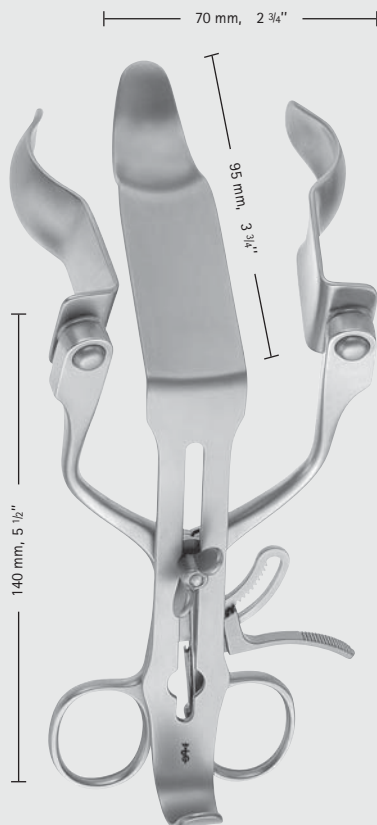

PARKS, MODIF. GIRONA

**BV585R**

Anal spreizer, komplett bestehend aus:

- BV581R Sperrer, allein
- BV582R Mittelblatt, allein
- BV583R Paar Blätter, allein
- BV584R Paar Blätter, allein

Rectal spreader, complete consisting of:

- BV581R Spreader, only
- BV582R Center blade, only
- BV583R Pair of blades, only
- BV584R Pair of blades, only



**BV583R**

Rektumblätter  
70 mm tief  
PAA = Paar  
Rectal blades  
70 mm deep  
PAA = pair



**BV584R**

Spinkterblätter  
93 mm tief  
PAA = Paar  
Sphincter blades  
93 mm deep  
PAA = pair



**BV586R**

Blätter für Anastomosen  
90 mm tief  
PAA = Paar  
nicht in BV585R enthalten  
Blades for anastomosis  
90 mm deep  
PAA = pair  
not included in BV585R



**PARKS**

**BV589R**

150 mm tief  
PAA = Paar  
nicht in BV585R enthalten  
150 mm deep  
PAA = pair  
not included in BV585R



**BV591R**

Mittelblatt für Kaltlicht mit Aufnahme für Kaltlichtstab OP801  
nicht in BV585R enthalten  
Center blade with connection for cold light carrier OP801  
not included in BV585R



**OP801**

Kaltlichtstab zur zusätzlichen, intensiven Ausleuchtung des OP-Feldes  
Cold light carrier for additional, intensive illumination of the operating area





Abdominale Chirurgie – Abdominal Surgery  
Rektum-Scheren  
Rectal Scissors

EA



LLOYD-DAVIES  
(GOLIGHER'S)

BC621R

270 mm, 10 <sup>3</sup>/<sub>4</sub>"

STELZNER

BC622R-BC623R

310 mm, 12 <sup>3</sup>/<sub>8</sub>"

BC617R

325 mm, 13"

MILLIMETERS



**Scheren – Scissors**  
Darmscheren, Rektumschere  
Bowel Scissors, Rectal Scissors

BC

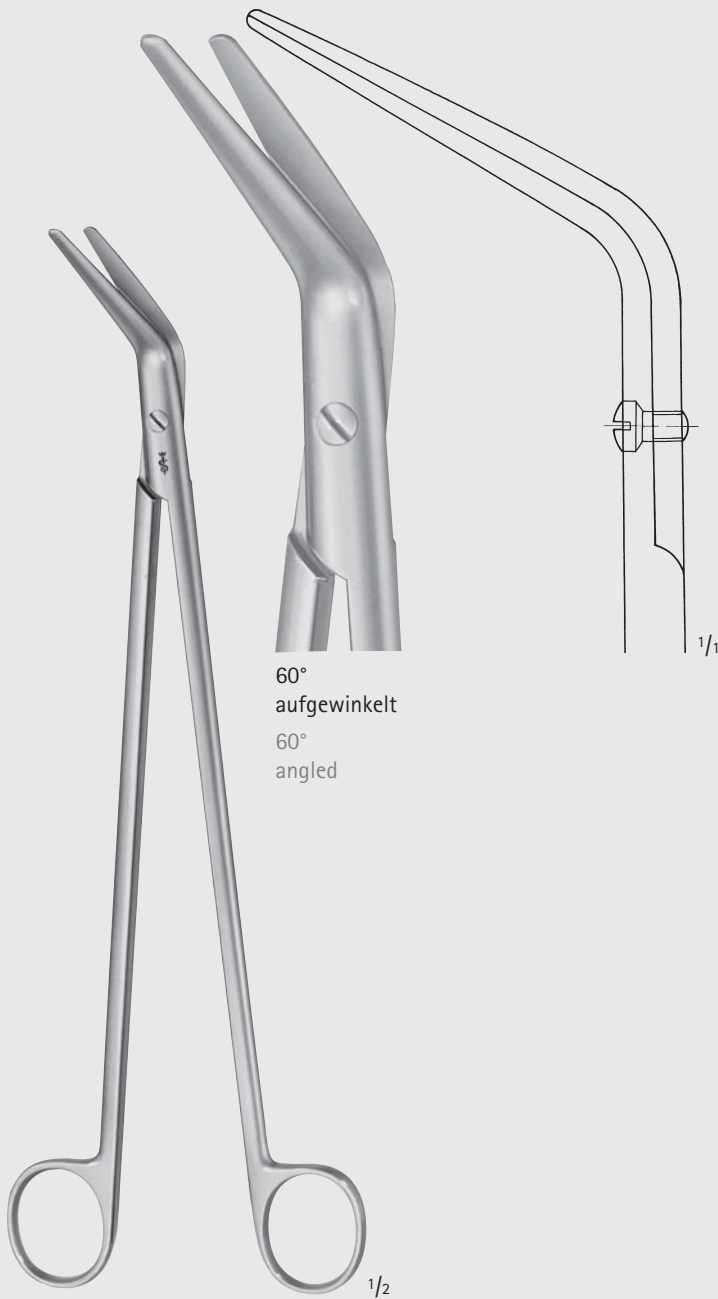

**BC624R**

Präparierschere  
zum Durchtrennen des Darms nach  
erfolgter Naht mit einem Naht-Gerät  
Dissecting scissors  
for cutting of the bowel after  
suturing with suture device  
280 mm, 11"





Scheren – Scissors  
Rektumschere  
Rectal Scissors

BC

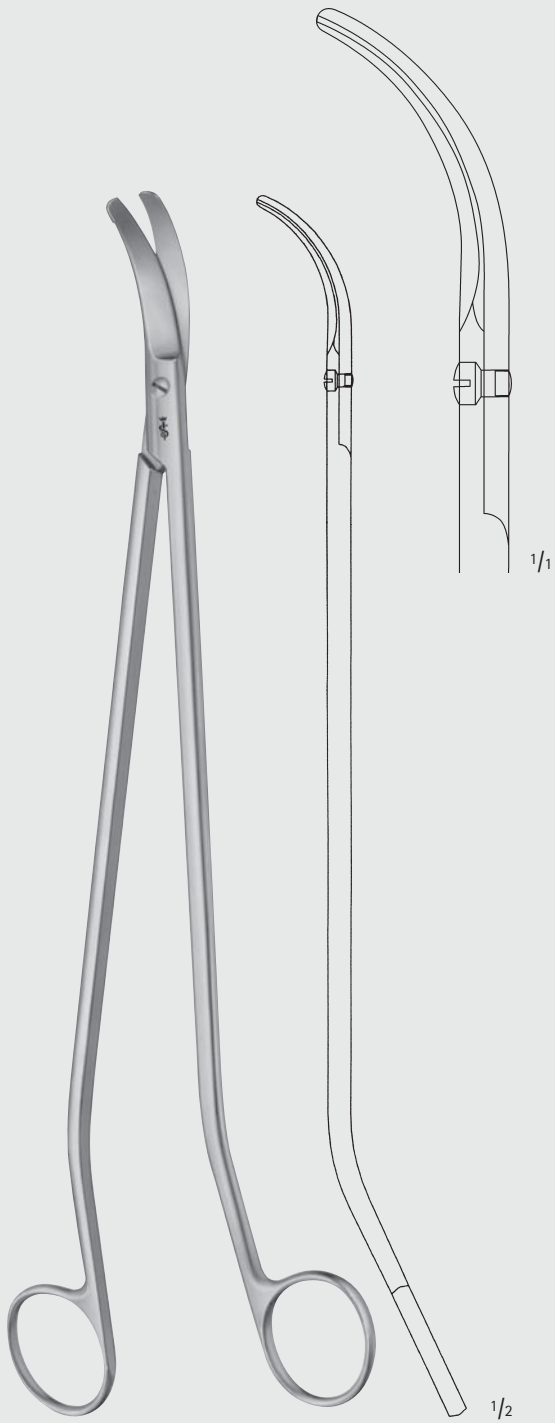

MÜLLER

BC627R

S-förmig

S-shaped

325 mm, 13"

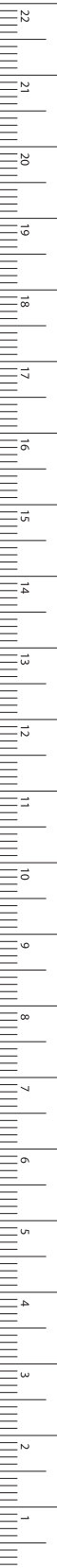

# Abdominale Chirurgie – Abdominal Surgery

## Mastdarm-Rektum-Spekula

### Rectal Specula

EA

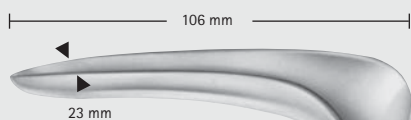

**CZERNY**  
**EA800R**  
225 mm, 9"

1/2

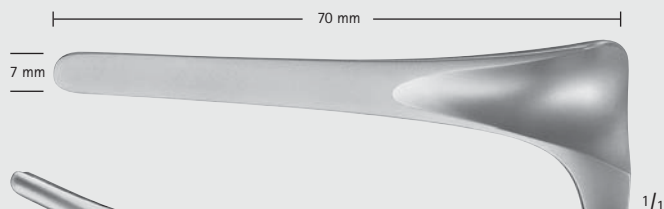

**KILLIAN**  
**OK093R**  
für Kinder  
for children  
145 mm, 5 1/2"

1/2



**SIMS**  
**EA820R**  
160 mm, 6 1/4"

1/2



**SIMS**  
**EA821R**  
160 mm, 6 1/4"

1/2



## Abdominale Chirurgie – Abdominal Surgery

### Mastdarm-Rektum-Spekula Rectal Specula



**EA825R-EA829R**



SIMS

**EA825R**

für Kinder

for children

190 mm, 7 1/2"

1/2

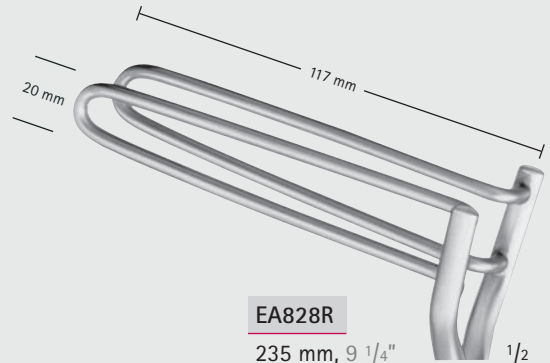

**EA828R**

235 mm, 9 1/4"

1/2



SIMS

**EA826R**

für Erwachsene

for adults

235 mm, 9 1/4"

1/2

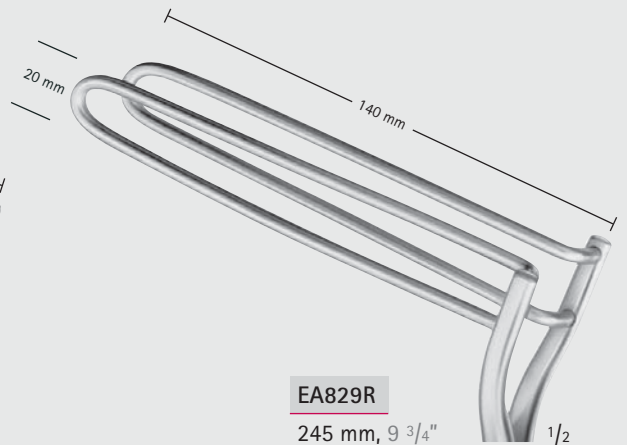

**EA829R**

245 mm, 9 3/4"

1/2



PRATT

**EA831R**

205 mm, 8"

1/2

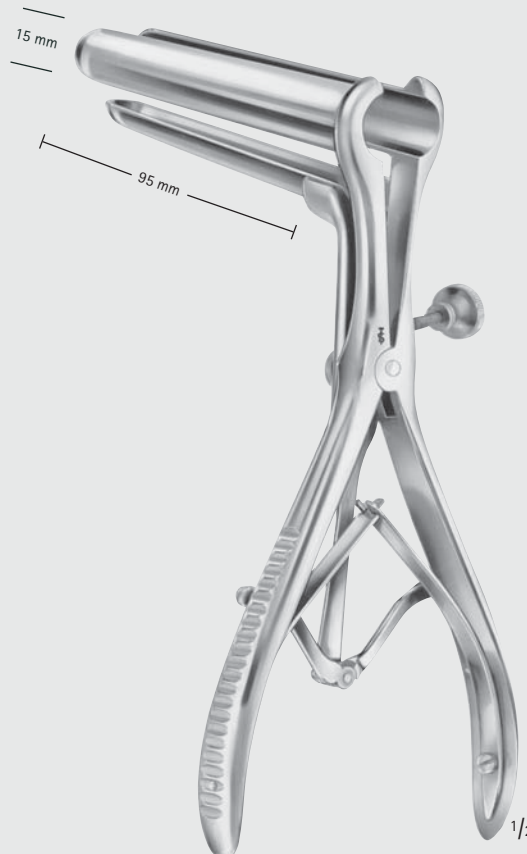

MATHIEU

**EA843R**

215 mm, 8 1/2"

1/2

EA

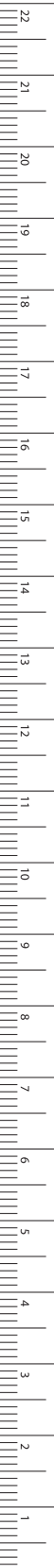

MILLIMETERS



**По вопросам продаж и поддержки обращайтесь:**

Алматы (7273)495-231	Казань (843)206-01-48	Новокузнецк (3843)20-46-81	Смоленск (4812)29-41-54
Архангельск (8182)63-90-72	Калининград (4012)72-03-81	Новосибирск (383)227-86-73	Сочи (862)225-72-31
Астрахань (8512)99-46-04	Калуга (4842)92-23-67	Омск (3812)21-46-40	Ставрополь (8652)20-65-13
Барнаул (3852)73-04-60	Кемерово (3842)65-04-62	Орел (4862)44-53-42	Сургут (3462)77-98-35
Белгород (4722)40-23-64	Киров (8332)68-02-04	Оренбург (3532)37-68-04	Тверь (4822)63-31-35
Брянск (4832)59-03-52	Краснодар (861)203-40-90	Пенза (8412)22-31-16	Томск (3822)98-41-53
Владивосток (423)249-28-31	Красноярск (391)204-63-61	Пермь (342)205-81-47	Тула (4872)74-02-29
Волгоград (844)278-03-48	Курск (4712)77-13-04	Ростов-на-Дону (863)308-18-15	Тюмень (3452)66-21-18
Вологда (8172)26-41-59	Липецк (4742)52-20-81	Рязань (4912)46-61-64	Ульяновск (8422)24-23-59
Воронеж (473)204-51-73	Магнитогорск (3519)55-03-13	Самара (846)206-03-16	Уфа (347)229-48-12
Екатеринбург (343)384-55-89	Москва (495)268-04-70	Санкт-Петербург (812)309-46-40	Хабаровск (4212)92-98-04
Иваново (4932)77-34-06	Мурманск (8152)59-64-93	Саратов (845)249-38-78	Челябинск (351)202-03-61
Ижевск (3412)26-03-58	Набережные Челны (8552)20-53-41	Севастополь (8692)22-31-93	Череповец (8202)49-02-64
Иркутск (395)279-98-46	Нижний Новгород (831)429-08-12	Симферополь (3652)67-13-56	Ярославль (4852)69-52-93
Россия (495)268-04-70	Киргизия (996)312-96-26-47	Казахстан (7172)727-132	