

# Технические характеристики

## По вопросам продаж и поддержки обращайтесь:

Алматы (7273)495-231	Казань (843)206-01-48	Новокузнецк (3843)20-46-81	Смоленск (4812)29-41-54
Архангельск (8182)63-90-72	Калининград (4012)72-03-81	Новосибирск (383)227-86-73	Сочи (862)225-72-31
Астрахань (8512)99-46-04	Калуга (4842)92-23-67	Омск (3812)21-46-40	Ставрополь (8652)20-65-13
Барнаул (3852)73-04-60	Кемерово (3842)65-04-62	Орел (4862)44-53-42	Сургут (3462)77-98-35
Белгород (4722)40-23-64	Киров (8332)68-02-04	Оренбург (3532)37-68-04	Тверь (4822)63-31-35
Брянск (4832)59-03-52	Краснодар (861)203-40-90	Пенза (8412)22-31-16	Томск (3822)98-41-53
Владивосток (423)249-28-31	Красноярск (391)204-63-61	Пермь (342)205-81-47	Тула (4872)74-02-29
Волгоград (844)278-03-48	Курск (4712)77-13-04	Ростов-на-Дону (863)308-18-15	Тюмень (3452)66-21-18
Вологда (8172)26-41-59	Липецк (4742)52-20-81	Рязань (4912)46-61-64	Ульяновск (8422)24-23-59
Воронеж (473)204-51-73	Магнитогорск (3519)55-03-13	Самара (846)206-03-16	Уфа (347)229-48-12
Екатеринбург (343)384-55-89	Москва (495)268-04-70	Санкт-Петербург (812)309-46-40	Хабаровск (4212)92-98-04
Иваново (4932)77-34-06	Мурманск (8152)59-64-93	Саратов (845)249-38-78	Челябинск (351)202-03-61
Ижевск (3412)26-03-58	Набережные Челны (8552)20-53-41	Севастополь (8692)22-31-93	Череповец (8202)49-02-64
Иркутск (395)279-98-46	Нижний Новгород (831)429-08-12	Симферополь (3652)67-13-56	Ярославль (4852)69-52-93
Россия (495)268-04-70	Киргизия (996)312-96-26-47	Казахстан (7172)727-132	



## Pinzetten – Dissecting- and Tissue Forceps

Feine anatomische Pinzetten  
Delicate Dissecting Forceps

BD

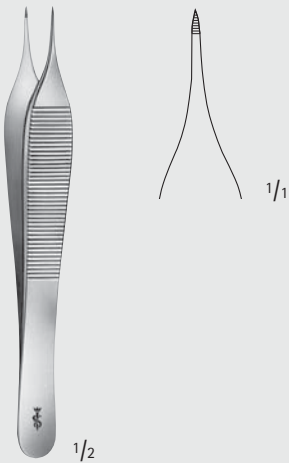

THORPE

**OC069R**

Hornhautpinzette  
Corneal forceps  
120 mm, 4 3/4"

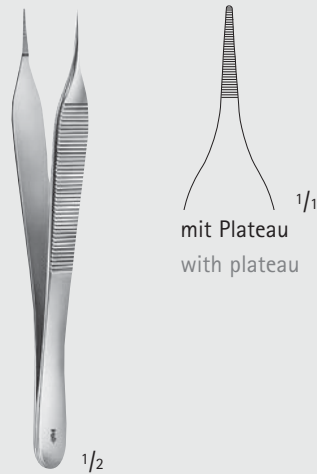

MICRO-ADSON

**BD220R**

120 mm, 4 3/4"

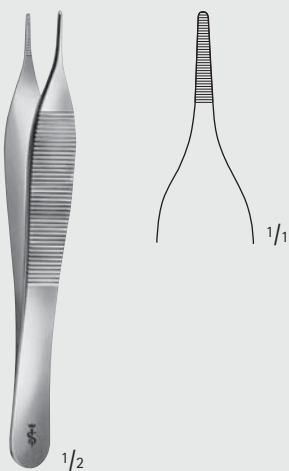

ADSON

**BD222R**

120 mm, 4 3/4"



HUDSON

**BD225R**

125 mm, 5"

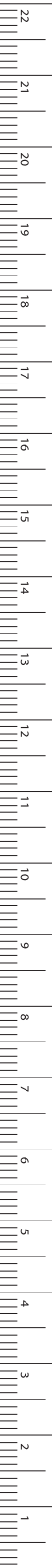

MILLIMETERS

# Pinzetten – Dissecting- and Tissue Forceps

Feine anatomische Pinzetten

Delicate Dissecting Forceps

BD

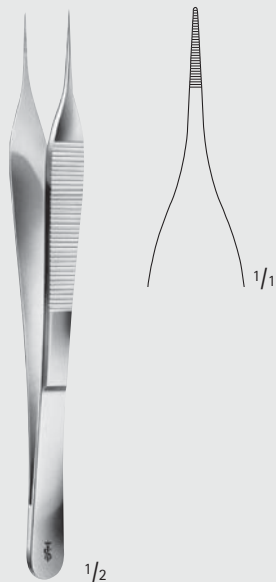

MICRO-ADSON

**BD223R**

150 mm, 6"

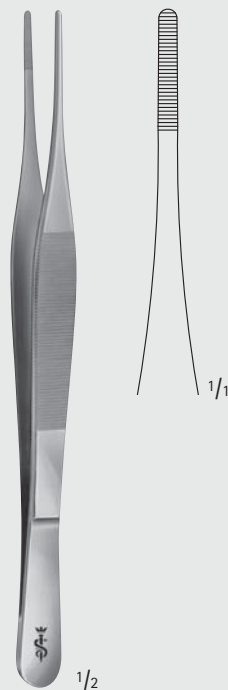

ADSON

**BD224R**

180 mm, 7"

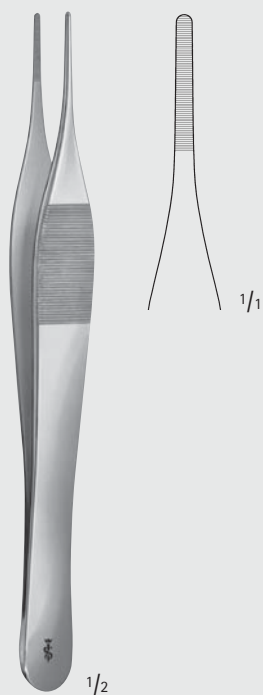

JEFFERSON

**BD226R**

180 mm, 7"

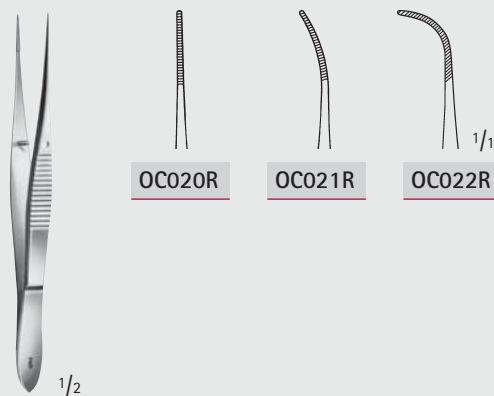

**OC020R-OC022R**

100 mm, 4"



# Pinzetten – Dissecting- and Tissue Forceps

Feine anatomische Pinzetten  
Delicate Dissecting Forceps

**BD**

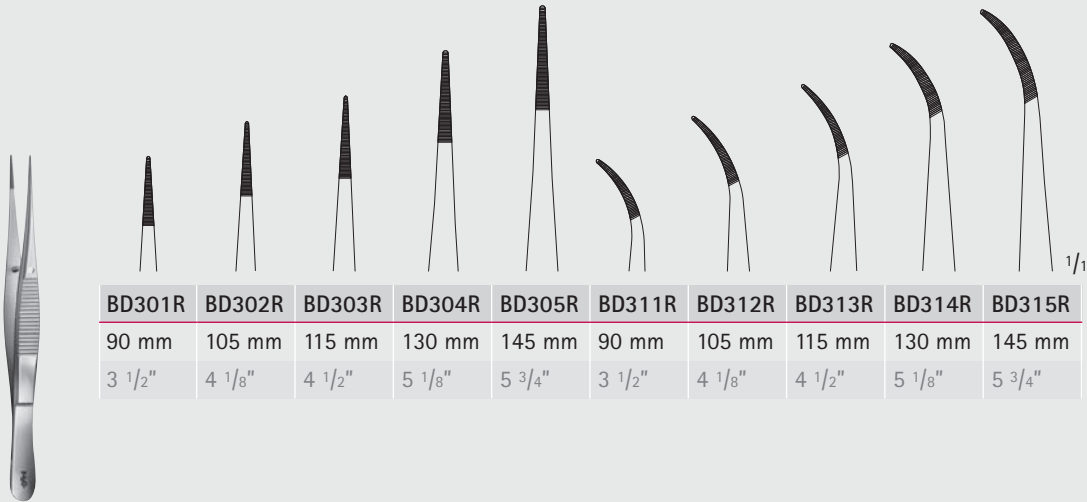

BD301R	BD302R	BD303R	BD304R	BD305R	BD311R	BD312R	BD313R	BD314R	BD315R
90 mm	105 mm	115 mm	130 mm	145 mm	90 mm	105 mm	115 mm	130 mm	145 mm
3 1/2"	4 1/8"	4 1/2"	5 1/8"	5 3/4"	3 1/2"	4 1/8"	4 1/2"	5 1/8"	5 3/4"

**BD301R-BD315R**



**BD210R**

115 mm, 4 1/2"



**BD320R**

100 mm, 4"

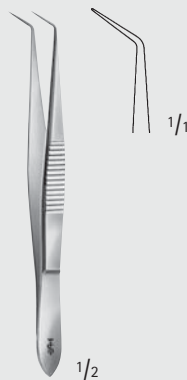

**BD321R**

100 mm, 4"

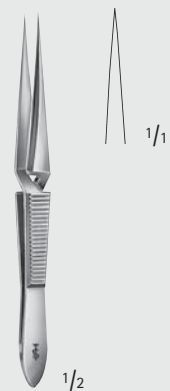

**BD322R**

100 mm, 4"



MILLIMETERS

# Pinzetten – Dissecting- and Tissue Forceps

Feine anatomische Pinzetten

Delicate Dissecting Forceps

BD

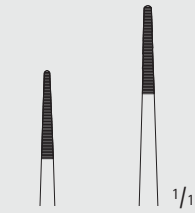
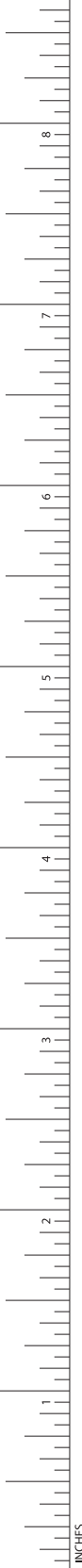

BD215R	BD216R
125 mm	150 mm
5"	6"

SEMKEN

**BD215R-BD216R**



1/2 155 mm, 6"

**BD217R**



1/2 150 mm, 6"

GILLIES

**BD213R**



1/2

MC INDOE

**BD236R**

150 mm, 6"

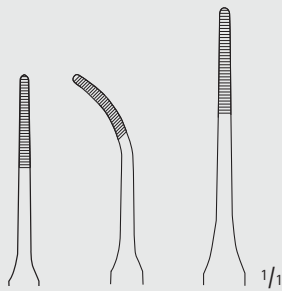

BD228R	BD229R	BD230R
175 mm	175 mm	230 mm
7"	7"	9"

GERALD

**BD228R-BD230R**

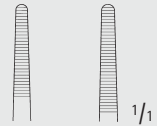

BD268R	BD269R
175 mm	215 mm
7"	8 1/2"

CAIRNS-DOTT

**BD268R-BD269R**



# Pinzetten – Dissecting- and Tissue Forceps

## Feine Anatomische Pinzetten

### Delicate Dissecting Forceps

**BD**

BD238R	BD239R	BD243R	BD240R
180 mm	200 mm	200 mm	250 mm
7"	8"	8"	10"

**CUSHING**

**BD238R-BD243R**

**BROPHY**

**BD246R-BD247R**

1/2 200 mm, 8"

**BD081R**

1/2 200 mm, 8"

BD231R	BD232R
185 mm	200 mm
7 1/4"	8"

**BD231R-BD232R**

glattes Maul  
smooth jaws

**COOLEY**

**BD250R**

1/2 200 mm, 8"

**BD257R**

1/2 200 mm, 8"



# Pinzetten – Dissecting- and Tissue Forceps

Anatomische Pinzetten

Dissecting Forceps

BD

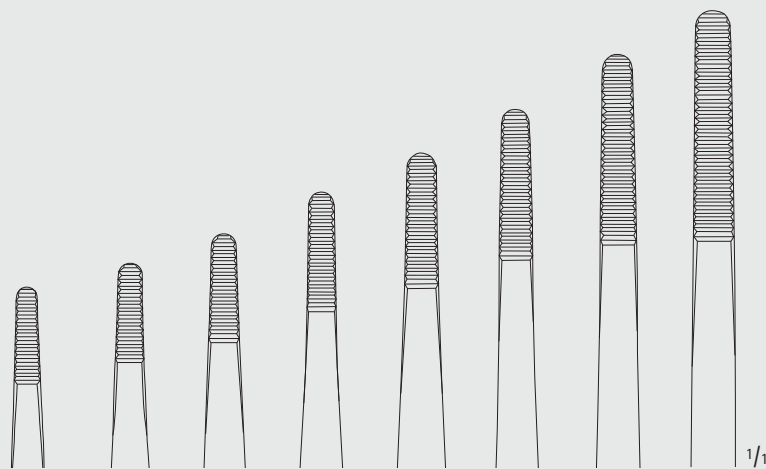

BD043R	BD045R	BD047R	BD049R	BD050R	BD051R	BD052R	BD053R
115 mm	130 mm	145 mm	160 mm	180 mm	200 mm	250 mm	300 mm
4 1/2"	5 1/8"	5 3/4"	6 1/4"	7"	8"	10"	12"

## BD043R-BD053R

Standard-Modelle

Standard patterns

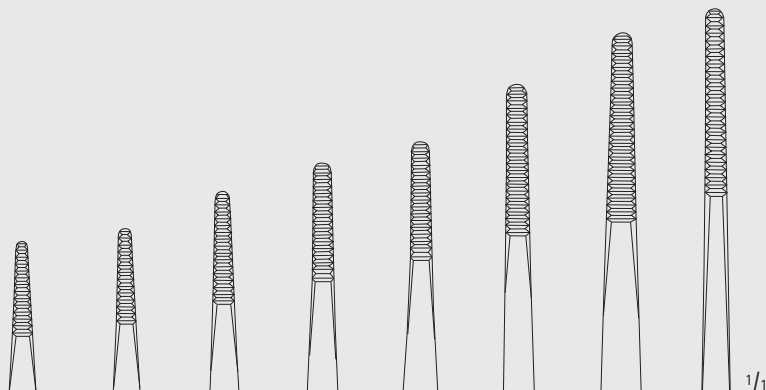

BD023R	BD025R	BD027R	BD029R	BD030R	BD031R	BD032R	BD033R
115 mm	130 mm	145 mm	160 mm	180 mm	200 mm	250 mm	305 mm
4 1/2"	5 1/8"	5 3/4"	6 1/4"	7"	8"	10"	12"

## BD023R-BD033R

mittelbreit

medium



# Pinzetten – Dissecting- and Tissue Forceps

## Anatomische Pinzetten

### Dissecting Forceps

BD

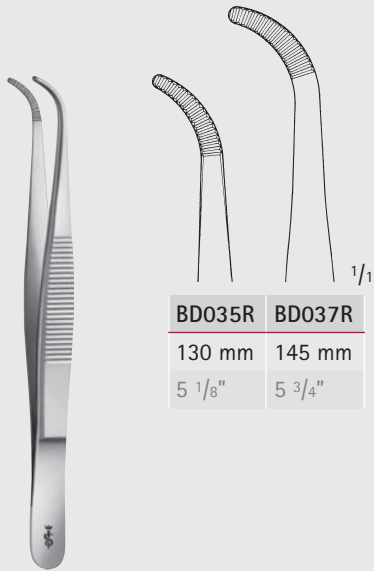

BD035R	BD037R
130 mm	145 mm
5 1/8"	5 3/4"

#### BD035R-BD037R

mittelbreit  
medium

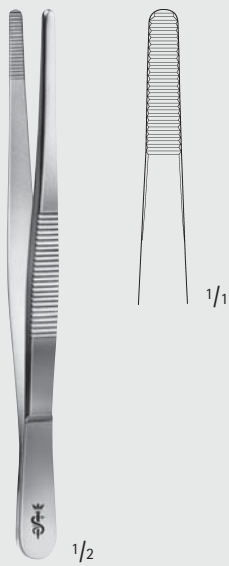

#### BD077R

extra breit  
extra large  
145 mm, 5 3/4"

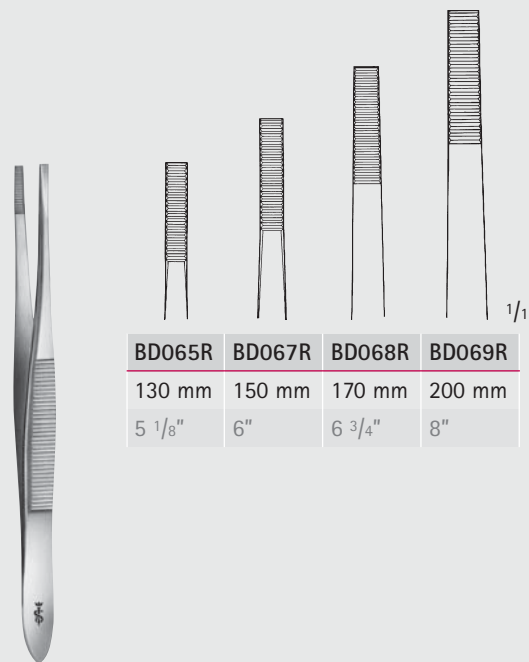

BD065R	BD067R	BD068R	BD069R
130 mm	150 mm	170 mm	200 mm
5 1/8"	6"	6 3/4"	8"

#### SCHWEDISCHES MODELL

#### BD065R-BD069R

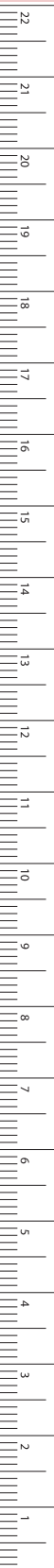

MILLIMETERS



# Pinzetten – Dissecting- and Tissue Forceps

Anatomische Pinzetten

Dissecting Forceps

BD

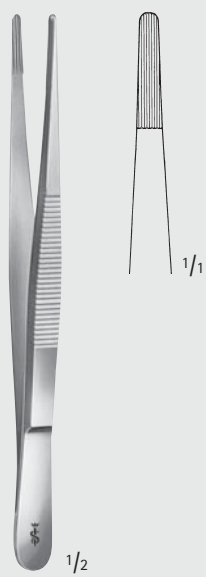

OCHSNER

**BD130R**

Fadenpinzette

Ligature forceps

145 mm, 5 3/4"

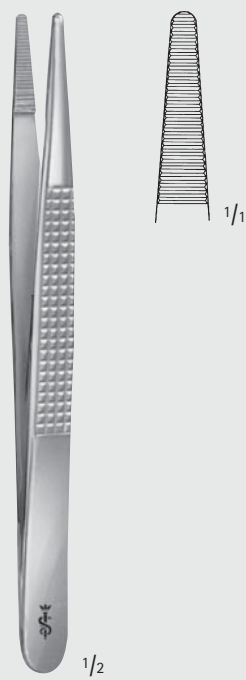

BONNEY

**BD078R**

175 mm, 7"

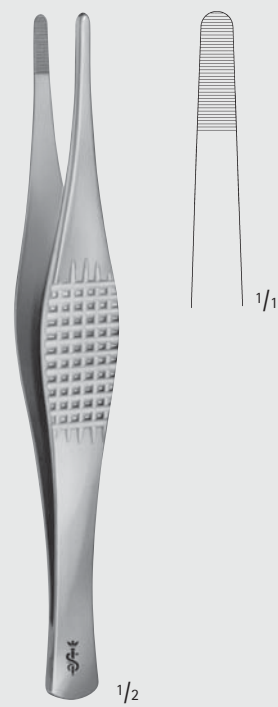

RAMSEY

**BD083R**

180 mm, 7"

# General Surgery

## Dissecting and Right Angle Forceps

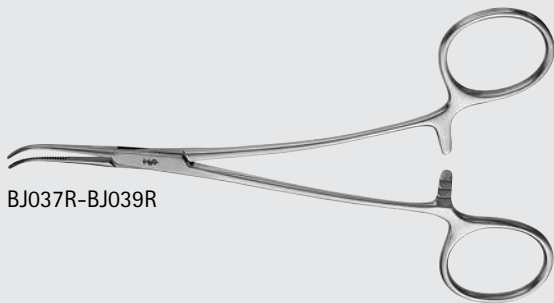
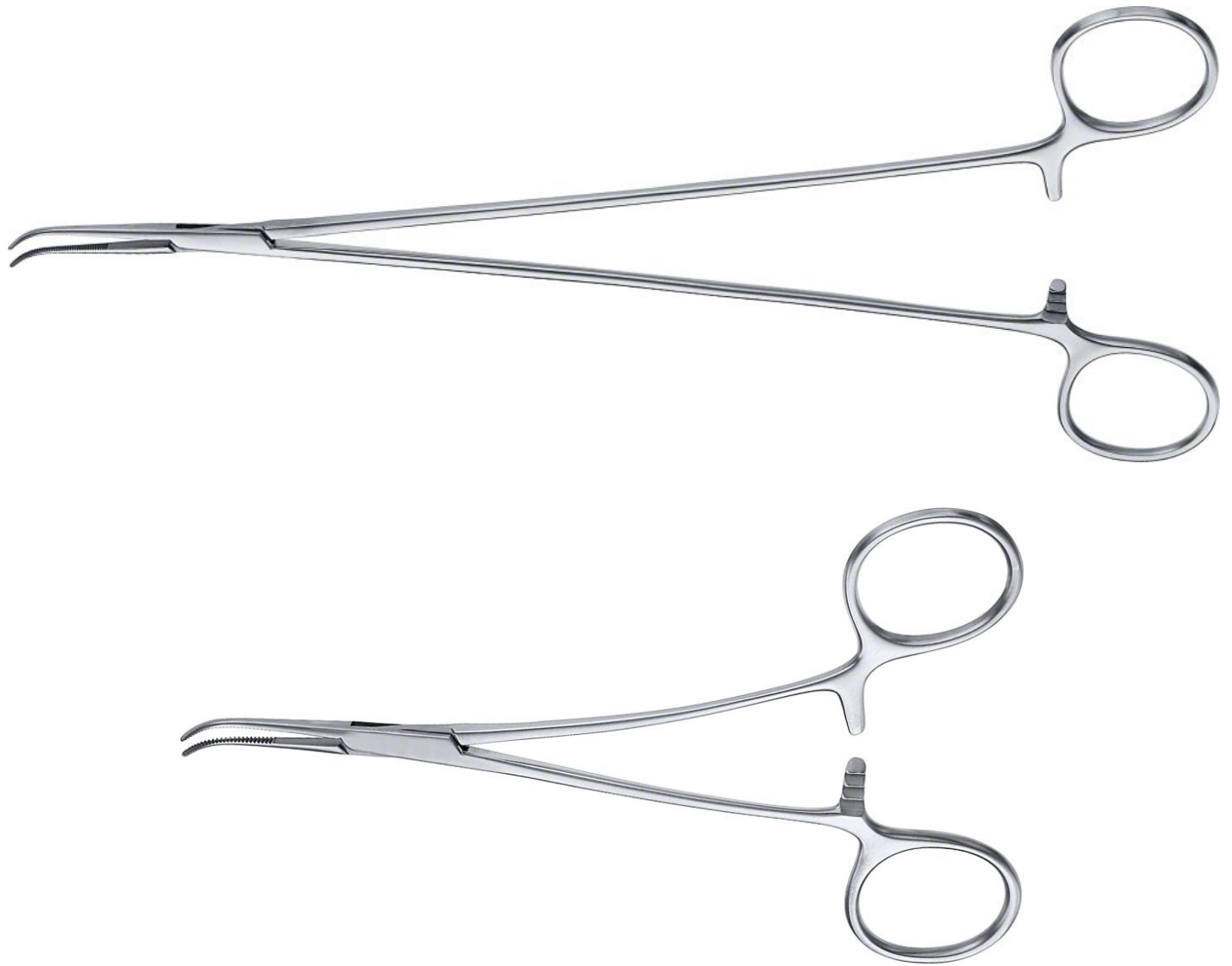

### HOLLE Forceps, Delicate

Catalog Number	Length (in.)
BJ037R	5 3/4
BJ038R	7 1/4
BJ039R	9 1/4



### XJ051U

Dissecting Forceps, 230 mm, japanese design, no teeth

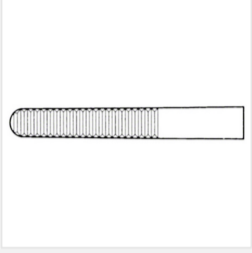

---

Data Matrix	Yes
Sterility	non-sterile
Disposable /	
Reusable	reusable



### XJ050U

Dissecting Forceps, 180 mm, japanese design, no teeth

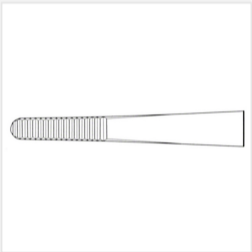

---

Data Matrix	Yes
Sterility	non-sterile
Disposable /	
Reusable	reusable



### DA204R

Tooth Tweezer, non-sterile, reusable

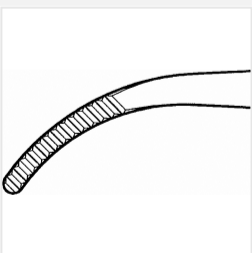

---

Product search type	Tooth Tweezer
Aesculap Product	
Groups	Dental
Discipline	Dental Surgery, Maxillo-Facial Surgery
Data Matrix	Yes
Product contains	
Latex	No
Sterility	non-sterile
Disposable /	
Reusable	reusable



### DA300R

Suture Forceps, angled, 150 mm (6"), serrated, non-sterile, reusable

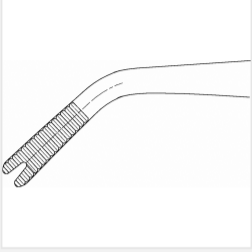
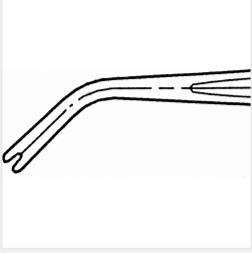

Product search type Suture Forceps

Aesculap Product

Groups	Dental
Geometry	angled
Length	150.00 mm
Length (Inch)	6
Jaw profile	serrated
Discipline	Maxillo-Facial Surgery, Dental Surgery
Data Matrix	Yes
Product contains	
Latex	No
Sterility	non-sterile
Disposable /	
Reusable	reusable



### XJ051R

Dissecting Forceps, 230 mm, japanese design, no teeth

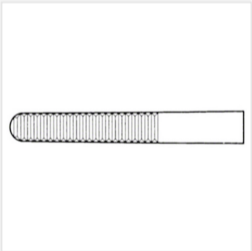

Data Matrix	Yes
Sterility	non-sterile
Disposable /	
Reusable	reusable

# Pinzetten – Dissecting- and Tissue Forceps

Chirurgische Pinzetten

Tissue Forceps

BD

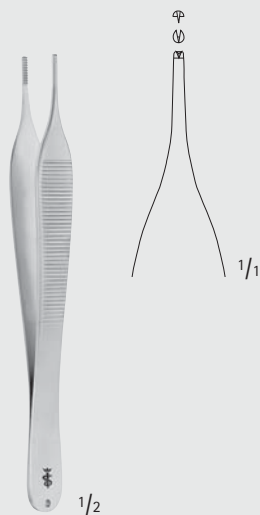

HUDSON

**MB291R**

125 mm, 4 7/8"



ADSON

**MB454R**

120 mm, 4 3/4"

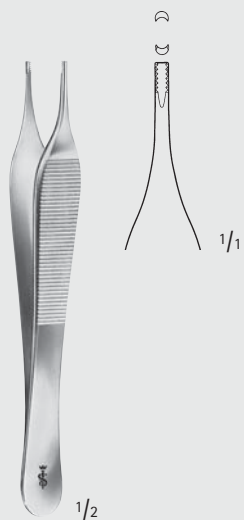

ADSON-BROWN

**BD700R**

Hautpinzette, scharf

Tissue forceps, sharp

120 mm, 4 3/4"

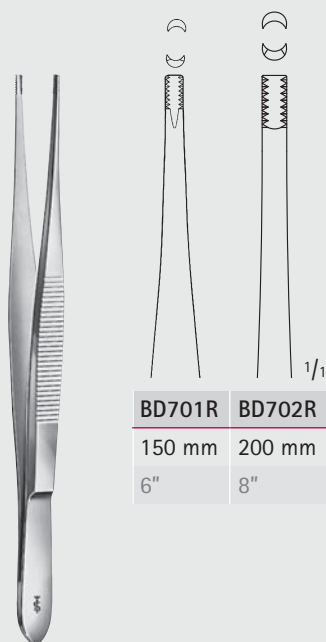

BROWN

**BD701R-BD702R**

<b>BD701R</b>	<b>BD702R</b>
150 mm	200 mm
6"	8"

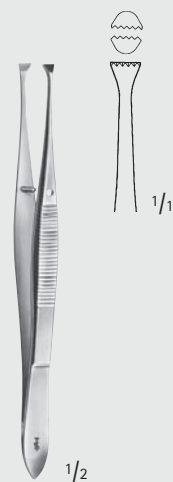

GRAEFFE

**OC100R**

110 mm, 4 1/2"



# Pinzetten – Dissecting- and Tissue Forceps

Chirurgische Pinzetten  
Tissue Forceps

BD

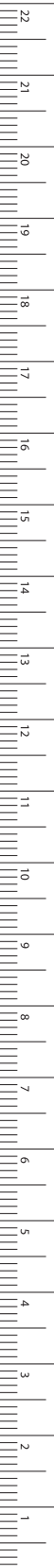

MILLIMETERS

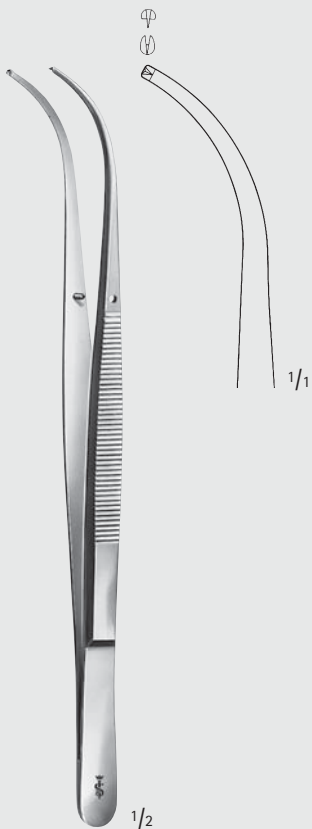

BROPHY

BD678R

200 mm, 8"



BD651R

200 mm, 8"



CUSHING

MD463

180 mm, 7"

# Pinzetten – Dissecting- and Tissue Forceps

Chirurgische Pinzetten

Tissue Forceps

BD

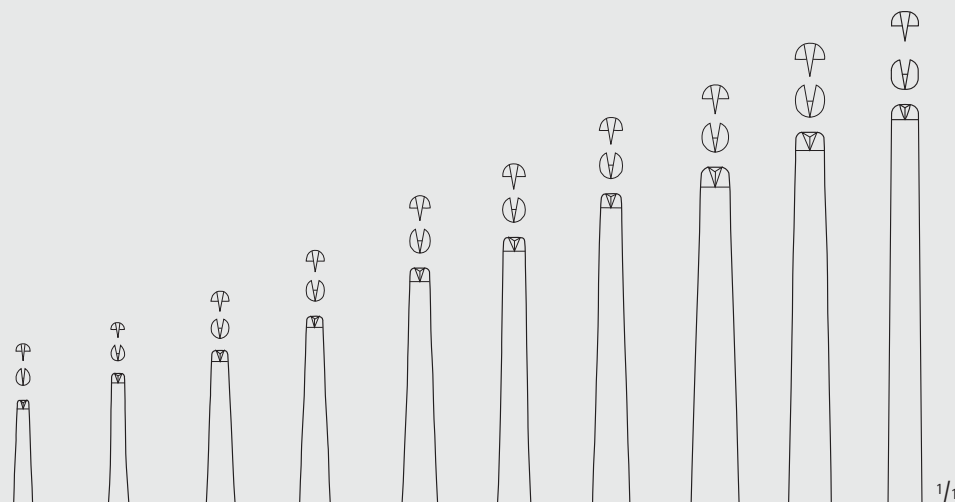

BD552R	BD553R	BD555R	BD557R	BD559R	BD560R	BD561R	BD562R	BD563R	BD564R
105 mm	115 mm	130 mm	145 mm	160 mm	180 mm	200 mm	250 mm	300 mm	350 mm
4 1/8"	4 1/2"	5 1/8"	5 3/4"	6 1/4"	7"	8"	10"	12"	14"

## BD552R-BD564R

Standard-Modelle

Standard patterns

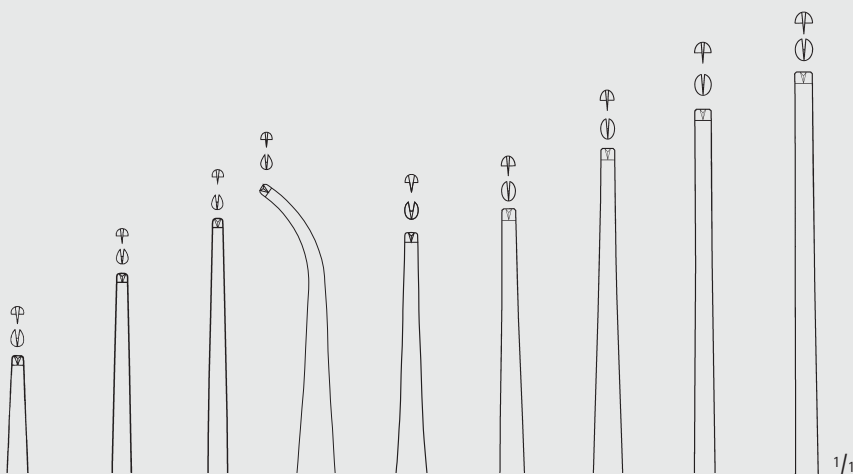

BD533R	BD535R	BD537R	BD527R	BD539R	BD540R	BD541R	BD542R	BD543R
115 mm	130 mm	145 mm	145 mm	160 mm	180 mm	200 mm	250 mm	300 mm
4 1/2"	5 1/8"	5 3/4"	5 3/4"	6 1/4"	7"	8"	10"	12"

## BD527R-BD543R

mittelbreit

medium



# Pinzetten – Dissecting- and Tissue Forceps

## Chirurgische Pinzetten

### Tissue Forceps

**BD**

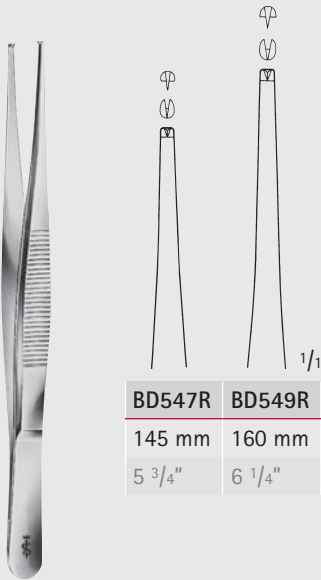

BD547R	BD549R
145 mm	160 mm
5 3/4"	6 1/4"

#### BD547R-BD549R

kräftiger als BD537R und BD539R  
aber feiner als BD557R und BD559R  
stronger as BD537R and BD539R  
but finer than BD557R and BD559R

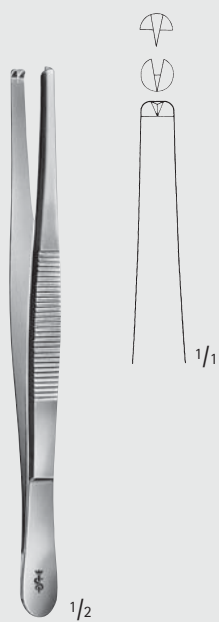

#### BD600R

kräftiges Modell  
heavy pattern  
145 mm, 5 3/4"

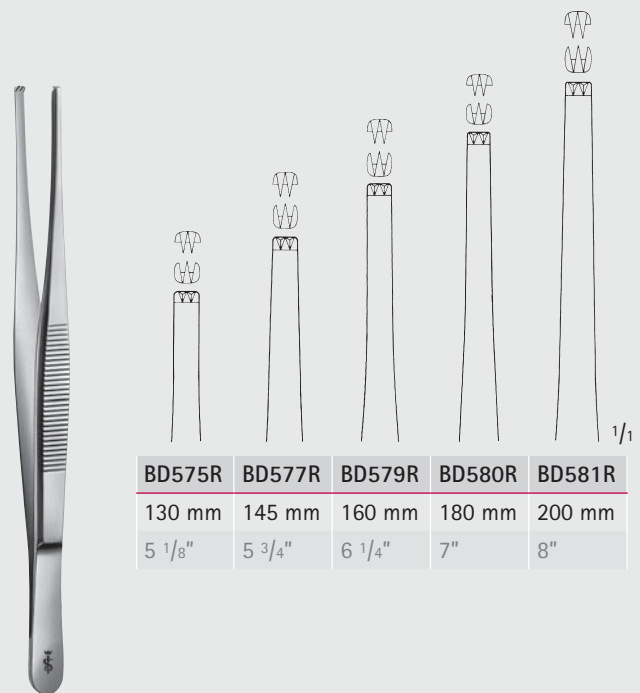

BD575R	BD577R	BD579R	BD580R	BD581R
130 mm	145 mm	160 mm	180 mm	200 mm
5 1/8"	5 3/4"	6 1/4"	7"	8"

#### BD575R-BD581R

2 x 3 Zähne  
2 x 3 teeth

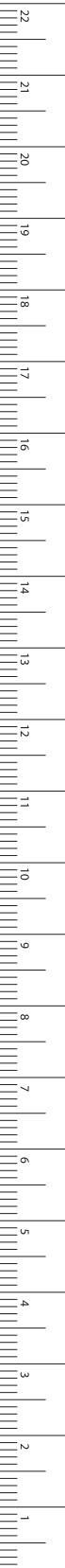

MILLIMETERS



# Pinzetten – Dissecting- and Tissue Forceps

Chirurgische Pinzetten

Tissue Forceps

BD

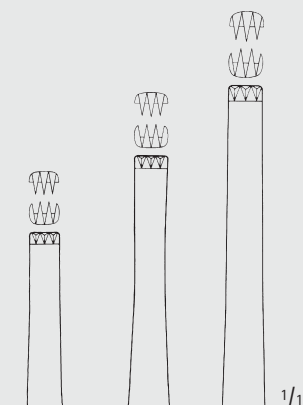

BD587R	BD589R	BD591R
145 mm	160 mm	200 mm
5 3/4"	6 1/4"	8"

**BD587R-BD591R**

3 x 4 Zähne  
3 x 4 teeth



1/1  
4 x 5 Zähne  
4 x 5 teeth

1/2

**BD597R**

145 mm, 5 3/4"



1/1  
4 x 5 Zähne  
4 x 5 teeth

1/1

1/2

**OFFICER**

**BD598R**

150 mm, 6"

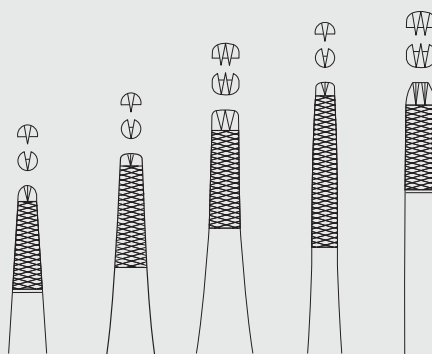

BD602R	BD603R	BD604R	BD606R	BD607R
125 mm	145 mm	145 mm	175 mm	175 mm
5"	5 3/4"	5 3/4"	7"	7"
		2 x 3 Zähne 2 x 3 teeth		2 x 3 Zähne 2 x 3 teeth

1/1

**LANE**

**BD602R-BD607R**



# Pinzetten – Dissecting- and Tissue Forceps

## Chirurgische Pinzetten

### Tissue Forceps

**BD**

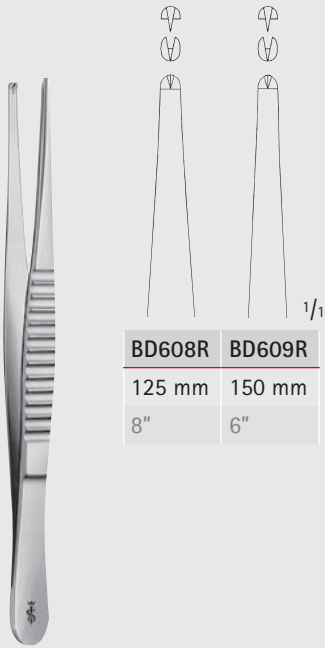
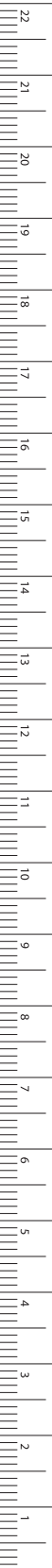

TREVES

**BD608R-BD609R**

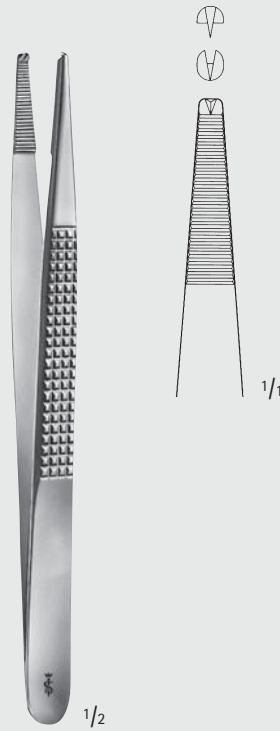

BONNEY

**BD693R**

175 mm, 7"

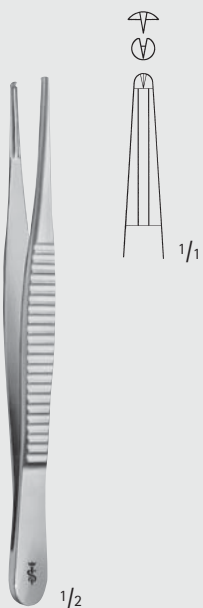

JACKSON-BURROWS

**BD704R**

140 mm, 5 1/2"

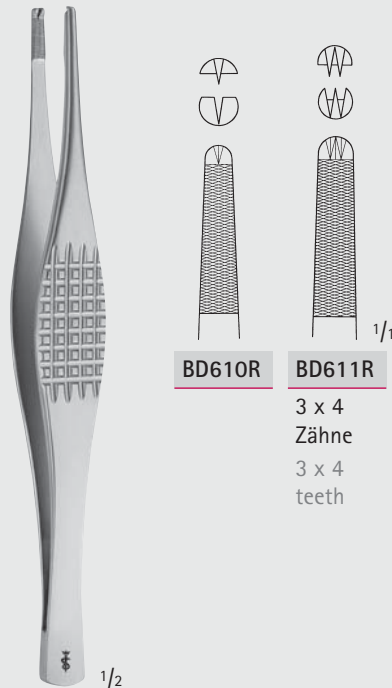

RAMSEY

**BD610R-BD611R**

180 mm, 7"

MILLIMETERS

# Pinzetten – Dissecting- and Tissue Forceps

Chirurgische Pinzetten

Tissue Forceps

BD

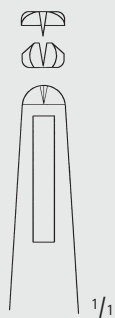

CHARNLEY

**BD705R**

180 mm, 7"

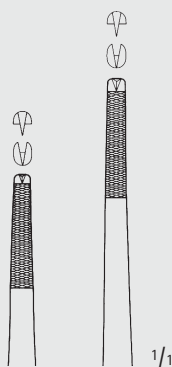

BD690R	BD692R
150 mm	200 mm
6"	8"

STRASSBURGER MODELL

**BD690R-BD692R**

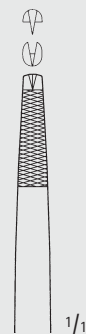

**BD185R**

Nahtpinzette  
Suture forceps  
300 mm, 12"



# Pinzetten – Dissecting- and Tissue Forceps

## Chirurgische Pinzetten

### Tissue Forceps

**BD**

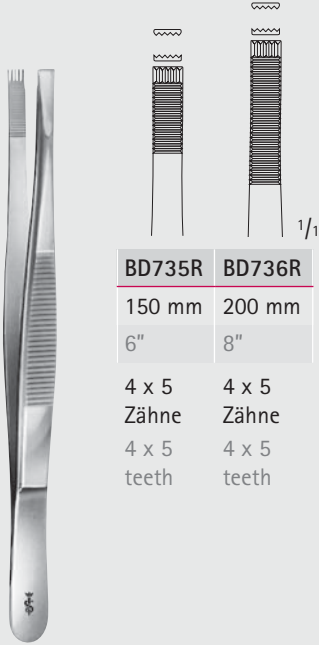

BD735R	BD736R
150 mm	200 mm
6"	8"
4 x 5 Zähne	4 x 5 Zähne
4 x 5 teeth	4 x 5 teeth

#### ADLERKREUTZ

**BD735R-BD736R**

Gefäß- und Tumorpinzette  
Vascular- and tumor forceps

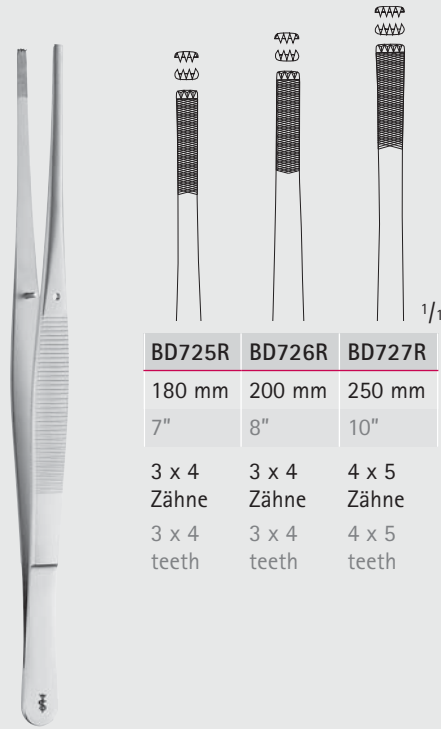

BD725R	BD726R	BD727R
180 mm	200 mm	250 mm
7"	8"	10"
3 x 4 Zähne	3 x 4 Zähne	4 x 5 Zähne
3 x 4 teeth	3 x 4 teeth	4 x 5 teeth

#### STILLE-BARRAYA

**BD725R-BD727R**

Gefäß- und Tumorpinzetten  
Vascular- and tumor forceps



#### RUSS. MODELL

**BD755R**

150 mm, 6"



#### RUSS. MODELL

**BD760R**

200 mm, 8"



#### SELMAN

**BD750R**

155 mm, 6"

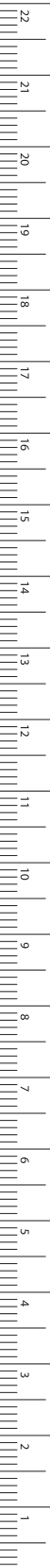

MILLIMETERS

Cardiovascular  
Dia Dust™ Forceps



BD200R-BD201R



BD200R-BD201R

Dia Dust THUMB Forceps, Flat Handle

Catalog Number	Tip	Tip Size (mm)	Length (in.)
BD200R	STR	1.0	7
BD201R	STR	1.0	8 1/4

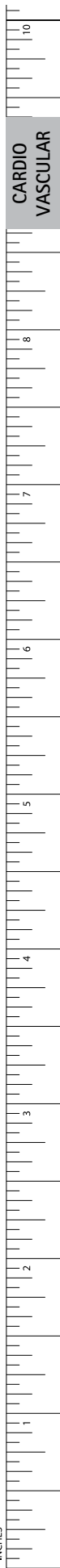

## Pinzetten – Dissecting- and Tissue Forceps

Feine chirurgische Pinzetten

Delicate Tissue Forceps

BD

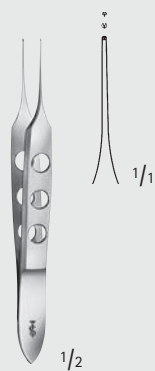

BISHOP-HARMON

OC051R

Augenpinzette

Eye forceps

85 mm, 3 1/2"

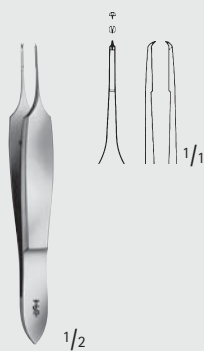

ST. MARTIN

OC091R

Augenpinzette

Eye forceps

80 mm, 3 1/8"

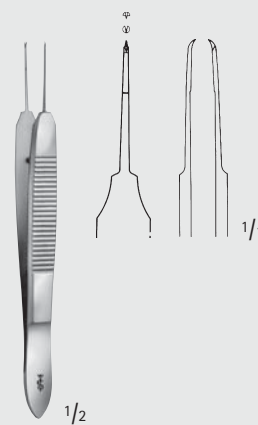

CASTROVIEJO

OC094R

Augenpinzette

Eye forceps

100 mm, 4"



MICRO-ADSON-BIEMER

BD509R

120 mm, 4 3/4"

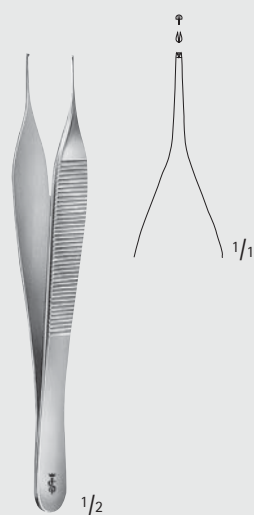

MICRO-ADSON

BD510R

120 mm, 4 3/4"

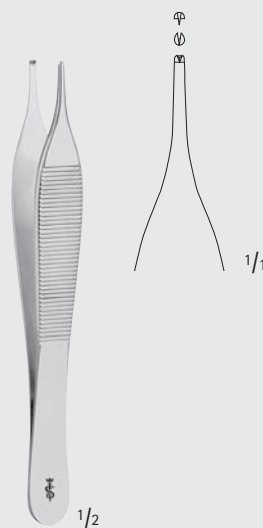

ADSON

BD511R

120 mm, 4 3/4"



ADSON

BD512R

120 mm, 4 3/4"



# Pinzetten – Dissecting- and Tissue Forceps

## Feine chirurgische Pinzetten

### Delicate Tissue Forceps

**BD**



**MICRO-ADSON**  
**BD520R**  
150 mm, 6"

**ADSON**  
**BD522R**  
180 mm, 7"

**JEFFERSON**  
**BD523R**  
180 mm, 7"

**ADSON**  
**BD508R**  
120 mm, 4 3/4"

**ADSON**  
**BD513R**  
120 mm, 4 3/4"

mit Plateau  
with plateau

**ADSON**  
**BD506R**  
120 mm, 4 3/4"

**ADSON**  
**BD507R**  
120 mm, 4 3/4"

**ADSON**  
**BD521R**  
150 mm, 6"



# Pinzetten – Dissecting- and Tissue Forceps

## Feine chirurgische Pinzetten

### Delicate Tissue Forceps

**BD**

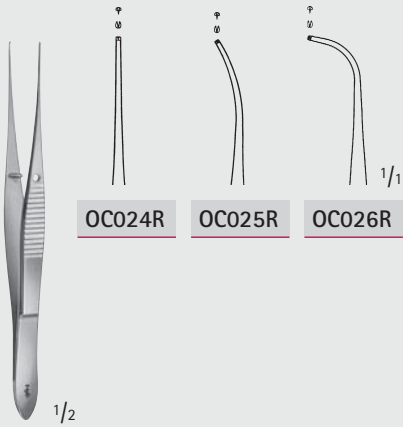

**OC024R**

**OC025R**

**OC026R**

**OC024R-OC026R**

sehr fein  
very delicate  
100 mm, 4"



**BD500R**

100 mm, 4"



**BD501R**

110 mm, 4 3/8"

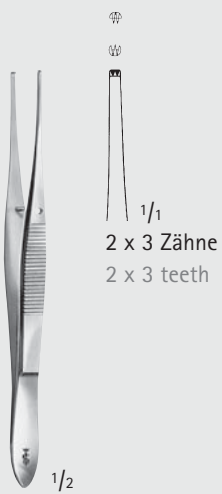

2 x 3 Zähne  
2 x 3 teeth

**BD502R**

110 mm, 4 3/8"



**BD665R**

**BD666R**

**BD667R**

125 mm

125 mm

150 mm

5"

5"

6"

2 x 3  
Zähne  
2 x 3  
teeth

**SEMKEN**

**BD665R-BD667R**

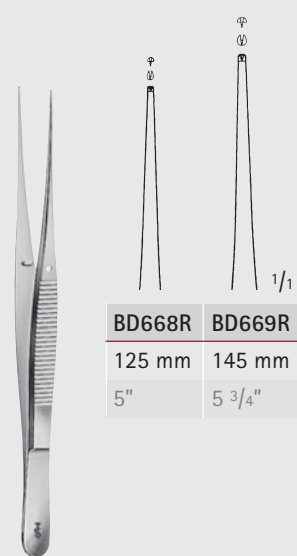

**BD668R**

**BD669R**

125 mm

145 mm

5"

5 3/4"

**SEMKEN**

**BD668R-BD669R**



MILLIMETERS



# Pinzetten – Dissecting- and Tissue Forceps

Feine chirurgische Pinzetten

Delicate Tissue Forceps

BD



GILLIES

**BD660R**

155 mm, 6"



MC INDOE

**BD661R**

150 mm, 6"

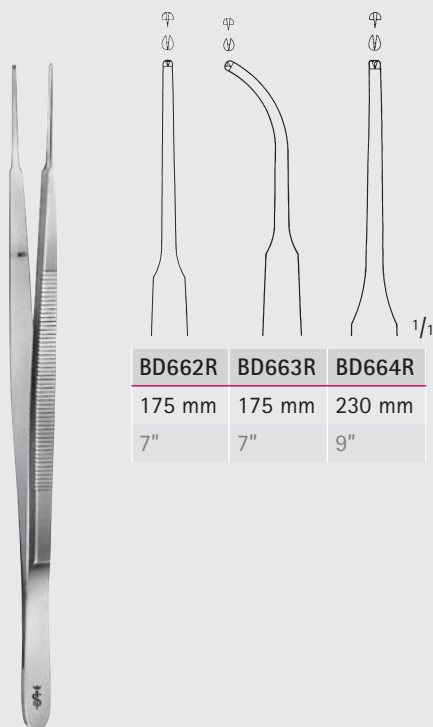

GERALD

**BD662R-BD664R**

BD662R	BD663R	BD664R
175 mm	175 mm	230 mm
7"	7"	9"



WAUGH

**BD670R-BD679R**

BD670R	BD671R	BD672R	BD679R
180 mm	200 mm	250 mm	305 mm
7"	8"	10"	12"

## Pinzetten – Dissecting- and Tissue Forceps

Lungenfasspinzetten, Darmpinzetten

Lung Grasping Dissecting Forceps, Intestinal Forceps

BD

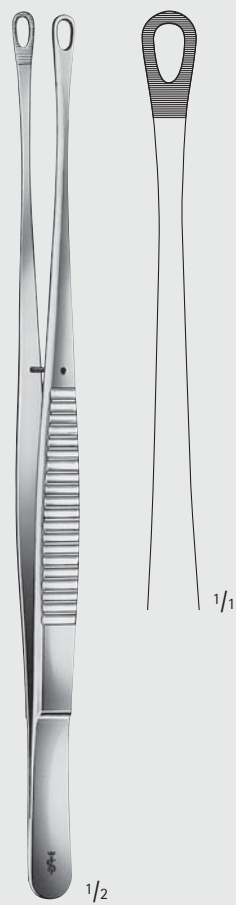

TUTTLE

**BD801R**

Lungenfasspinzette  
Lung grasping forceps  
230 mm, 9"

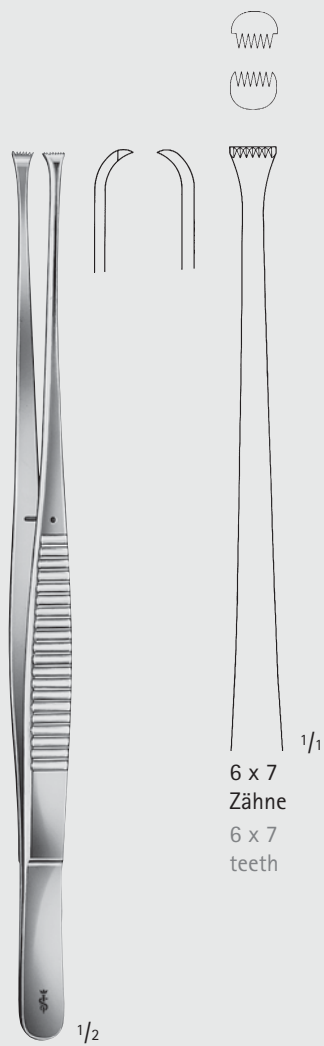

NELSON

**BD802R**

Lungenfasspinzette  
Lung grasping forceps  
230 mm, 9"



DUVAL

**BD820R**

Darmpinzette  
Intestinal forceps  
140 mm, 5 1/2"



DENIS- BROWNE

**EA027R**

Darmpinzette  
Intestinal forceps  
190 mm, 7 1/2"



# Pinzetten – Dissecting- and Tissue Forceps

## Mikro-Knüpfpinzetten

### Mico Suture Tying Forceps

**BD**

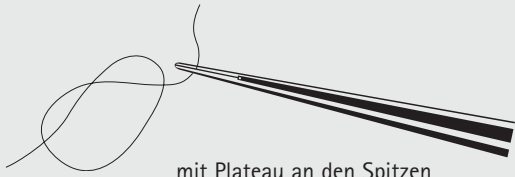

mit Plateau an den Spitzen  
with plateau at the tips

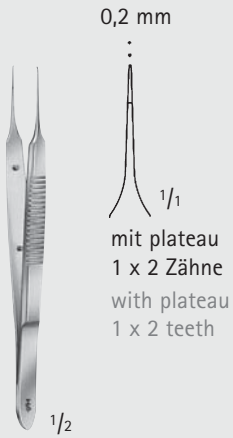

**BONNER MODELL**

**BD505R**

95 mm, 3 3/4"



**BD338R**

120 mm, 4 3/4"

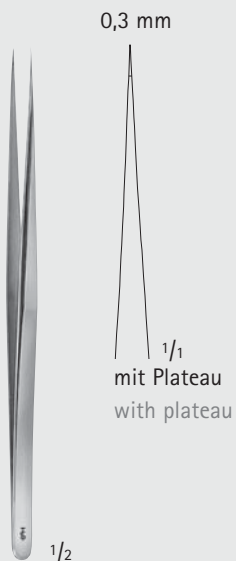

**WISE**

**BD336R**

135 mm, 5 1/4"

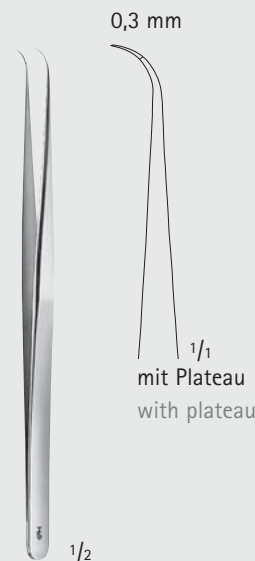

**WISE**

**BD337R**

135 mm, 5 1/4"



MILLIMETERS

# Pinzetten – Dissecting- and Tissue Forceps

Mikro-Knüpfpinzetten

Mico Suture Tying Forceps

BD



0,5 mm



1/2

LAZAR

**BD260R**

155 mm, 6"

0,8 mm



1/2

LAZAR

**BD261R**

155 mm, 6"

0,5 mm



mit Plateau  
with plateau

1/2

**BD264R**

185 mm, 7 1/4"

0,8 mm

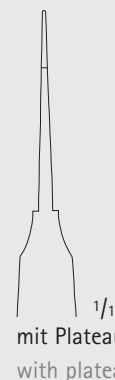

mit Plateau  
with plateau

1/2

AUSTIN

**BD340R**

140 mm, 5 1/2"



## Pinzetten – Dissecting- and Tissue Forceps

### Mikro-Knüpfpinzetten mit Rundgriffen

#### Micro Suture Tying Forceps with Round Handle



... mit Rundgriffen

- Rundgriffe erlauben Drehbewegungen zwischen den Fingern.
- Optimale Balance, individuell je nach Instrument, durch volle oder gehöhlte Griffpartien.

... with round handles

- Round handles allow turning manipulations between the fingers.
- Optimum balance individually for each instrument due to solid or hollowed-out handles.

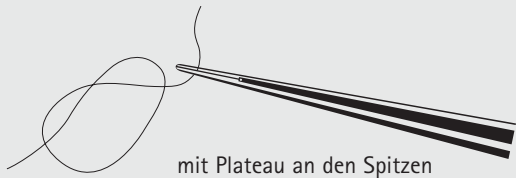

mit Plateau an den Spitzen  
with plateau at the tips

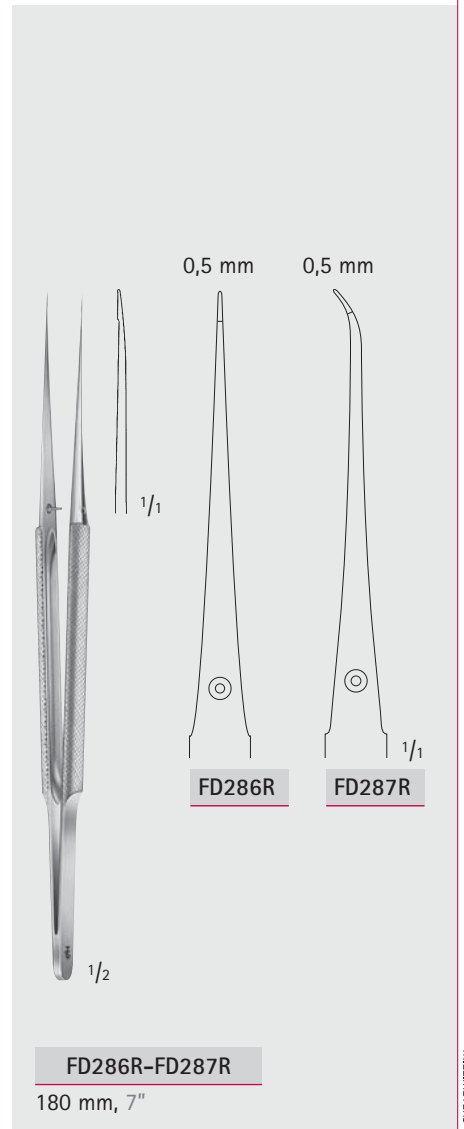
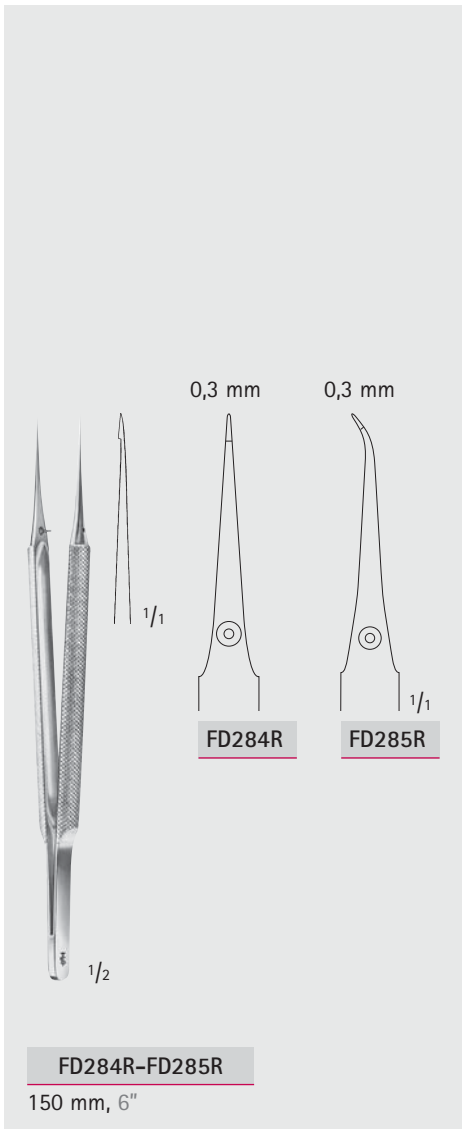
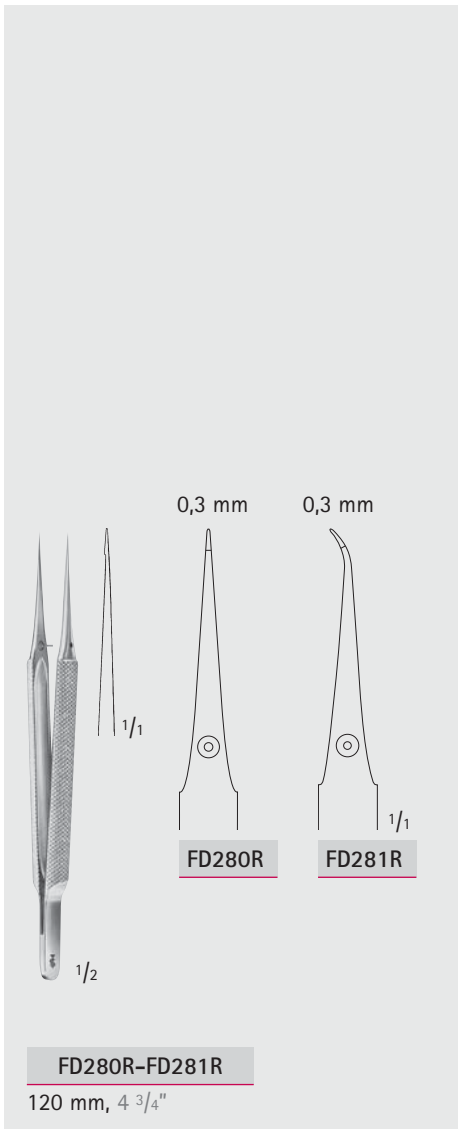

BD

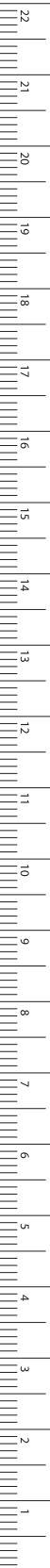

MILLIMETERS

## Instruments – Instrumente

Micro Tumor Grasping Forceps with microform Handle, Bayonet-shaped

Mikro-Tumorfasspinzetten mit microform Griff, bajonettförmig

Micro  
Mikro

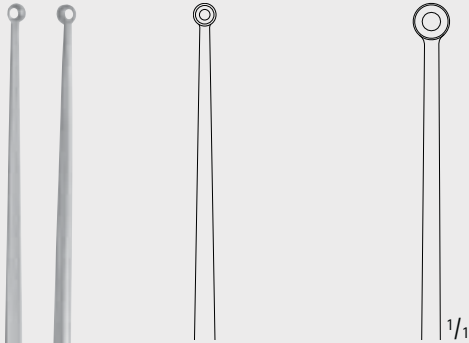

**FD210R**

Diam. of ring: 3 mm  
Ring-Ø: 3 mm

**FD212R**

Diam. of ring: 5 mm  
Ring-Ø: 5 mm



YASARGIL

**FD210R-FD212R**

Jaw spoon-shaped  
Maul löffelförmig  
220 mm, 8 3/4"

1/1

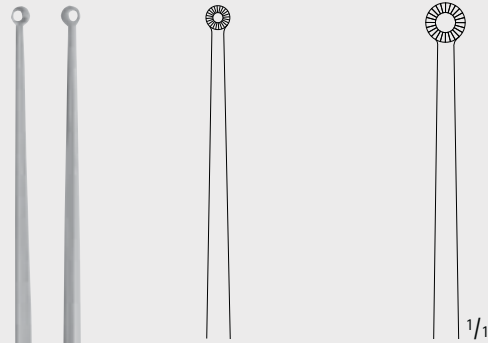

**FD214R**

Diam. of ring: 3 mm  
Ring-Ø: 3 mm

**FD216R**

Diam. of ring: 5 mm  
Ring-Ø: 5 mm



YASARGIL

**FD214R-FD216R**

Jaw flat, serrated  
Maul flach, gezahnt  
220 mm, 8 3/4"

1/1

## Instruments - Instrumente

### Micro Tumor Grasping Forceps with microform Handle, Bayonet-shaped Mikro-Tumorfasspinzetten mit microform Griff, bajonettförmig

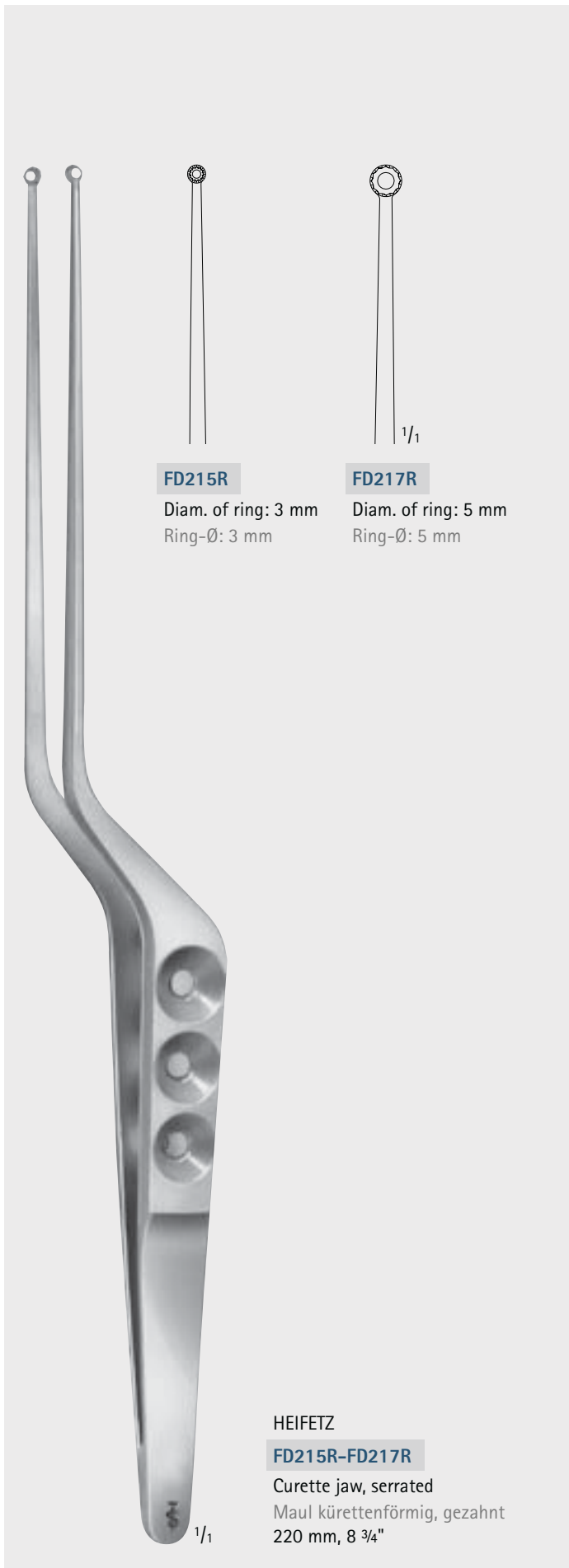

## Instruments – Instrumente

### Micro Tumor Grasping Forceps

### Mikro-Tumorfasspinzetten

Micro  
Mikro



HUNT

**BD765R**

serrated,  
with flat handle, straight  
gezahnt,  
mit Flachgriff, gerade  
200 mm, 7 7/8"

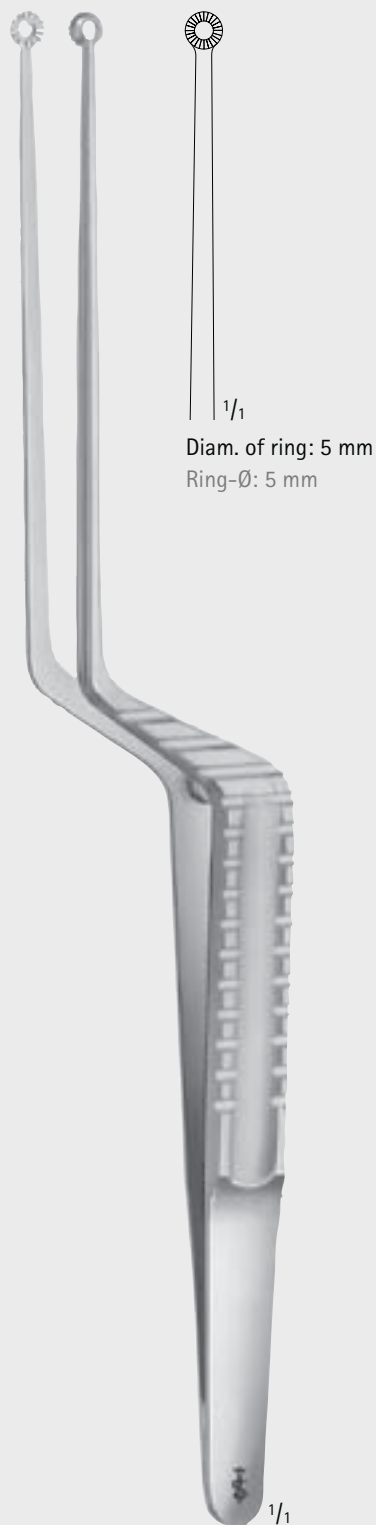

HUNT

**BD766R**

serrated,  
with flat handle, bayonet-shaped  
gezahnt,  
mit Flachgriff, bajonettförmig  
200 mm, 7 7/8"



YASARGIL

**BD768R**

serrated,  
with flat handle, bayonet-shaped  
gezahnt,  
mit Flachgriff, bajonettförmig  
200 mm, 7 7/8"



# Neurosurgery

## Pituitary Instruments

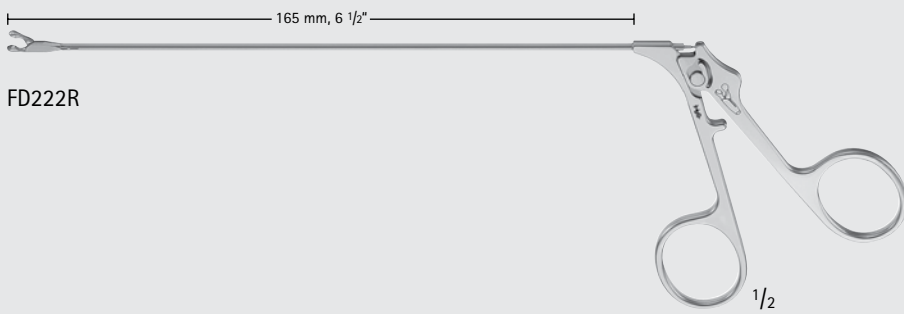

FD222R

### NICOLA Modular Micro Forceps

Catalog Number	Jaw	Tip Size (mm)	Working Length (in.)
FD222R	SCOOP-SHAPED	DIAM. 2.5 MM	6 1/2

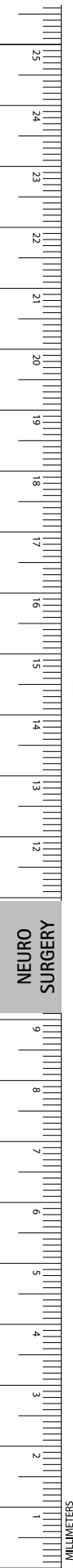

NEURO SURGERY



# Knochenstanzen, Rongeurs – Bone Punches, Rongeurs

Rongeurs  
Rongeurs

FF

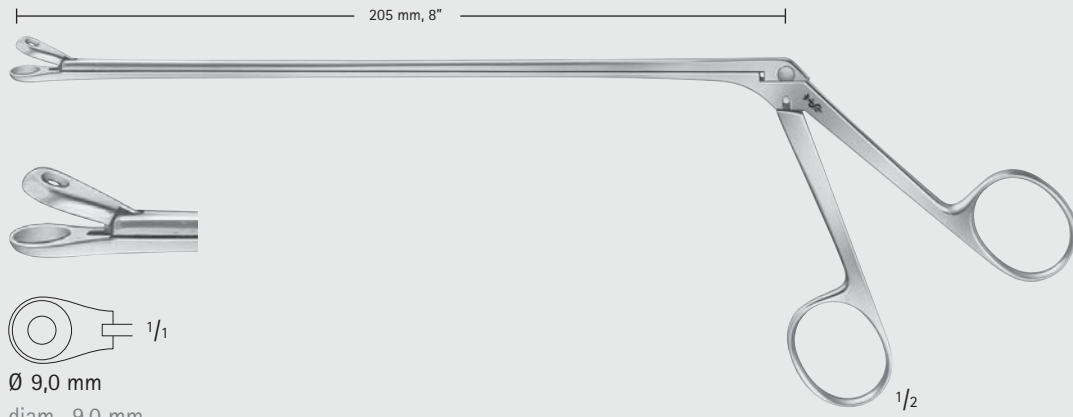

Ø 9,0 mm  
diam. 9.0 mm

LANDOLT

FF345R

Tumorfasszange, stumpf  
Tumor grasping forceps, blunt



MILLIMETERS



**Pinzetten – Dissecting- and Tissue Forceps**  
 Pinzetten, bajonettförmig gebogen  
 Forceps, Bayonet-Shaped

**BD**

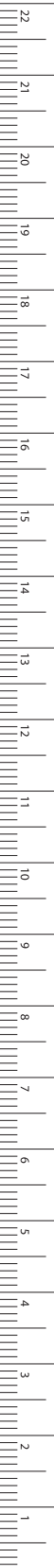

MILLIMETERS

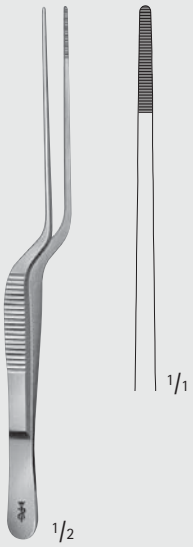

LUCAE

**BD878R**

140 mm, 5 1/2"

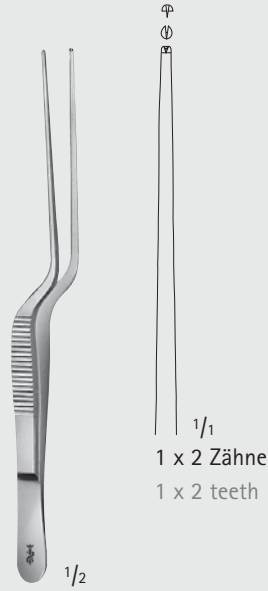

LUCAE

**BD879R**

140 mm, 5 1/2"



COTTLE

**OLO11R**

Fixierpinzette  
 Forceps  
 140 mm, 5 1/2"

gezahnt  
 und gerieft  
 toothed  
 and serrated

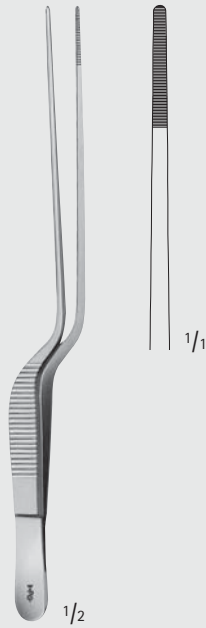

JANSEN

**BD880R**

160 mm, 6 1/4"

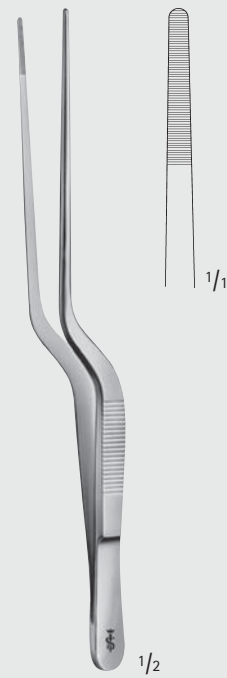

ADSON

**BD870R**

175 mm, 7"

## Pinzetten – Dissecting- and Tissue Forceps

Pinzetten, bajonettförmig gebogen

Forceps, Bayonet-Shaped

BD

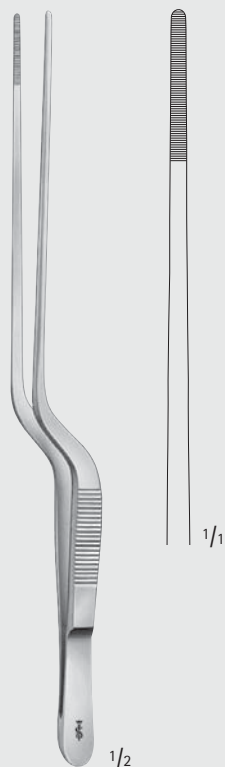

GRUENWALD

**BD883R**

200 mm, 8"

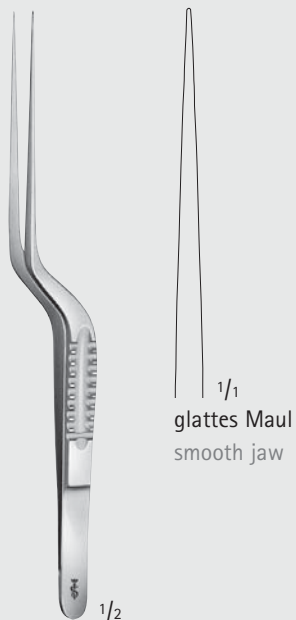

glattes Maul  
smooth jaw

**BD887R**

160 mm, 6 1/4"

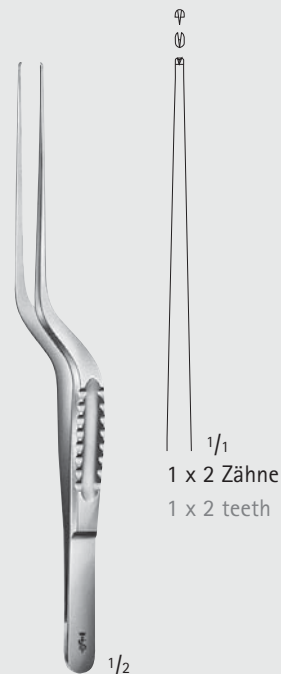

1 x 2 Zähne  
1 x 2 teeth

**BD888R**

160 mm, 6 1/4"



glattes Maul  
smooth jaw

**BD885R**

185 mm, 7 1/4"

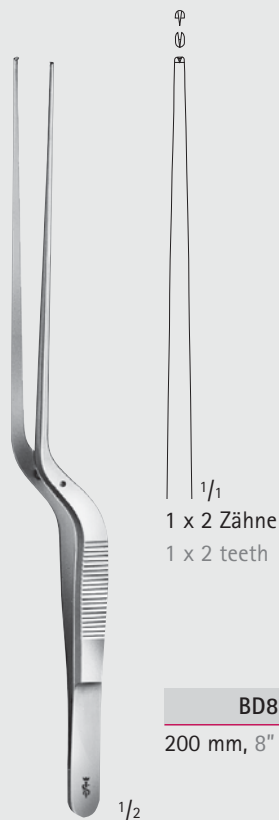

1 x 2 Zähne  
1 x 2 teeth

**BD886R**

200 mm, 8"



## Pinzetten – Dissecting- and Tissue Forceps

Pinzetten, kniegebogen  
Forceps, Angular

BD



TROELTSCH

**BD900R**

100 mm, 4"

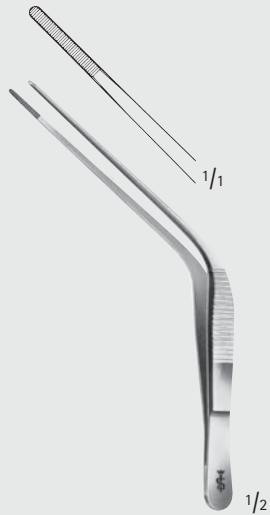

TROELTSCH

**BD902R**

115 mm, 4 1/2"



TROELTSCH

**BD903R**

115 mm, 4 1/2"



WILDE

**BD904R**

115 mm, 4 1/2"

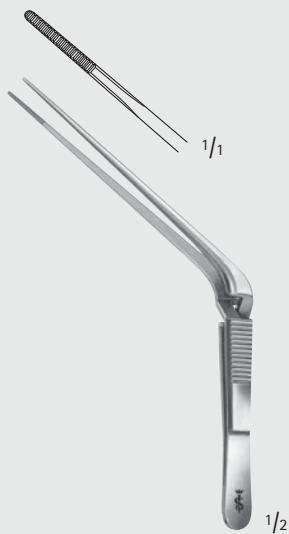

TROELTSCH

**BD905R**

selbstschließend  
cross action  
120 mm, 4 3/4"

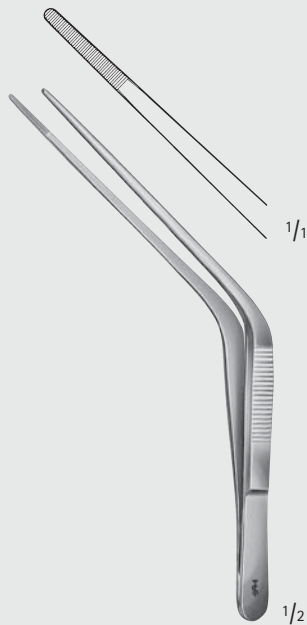

TROELTSCH

**BD910R**

140 mm, 5 1/2"

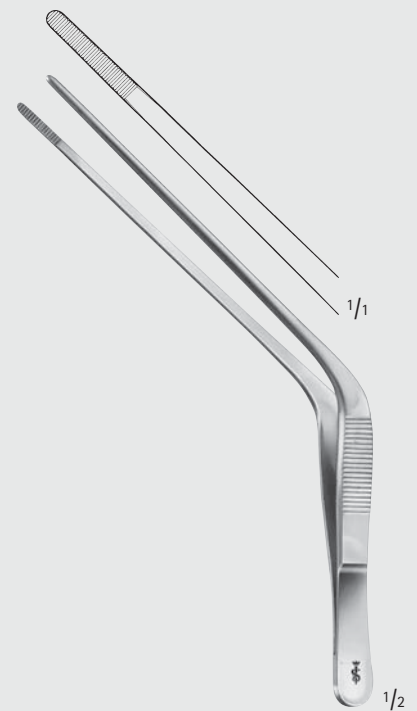

TROELTSCH

**BD911R**

170 mm, 6 3/4"



MILLIMETERS



## Pinzetten – Dissecting- and Tissue Forceps

### Splitterpinzetten, Splitterzangen

### Splinter Forceps

BD



**BD952R**

Splitterpinzette  
Splinter forceps  
80 mm, 3 1/8"

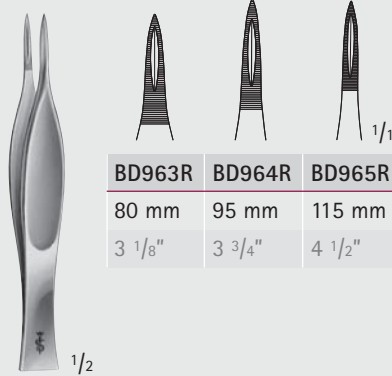

**FEILCHENFELD**

**BD963R-BD965R**

Splitterpinzetten  
Splinter forceps

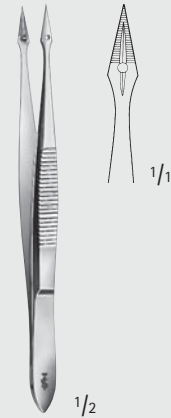

**HUNTER**

**BD980R**

Splitterpinzette  
Splinter forceps  
105 mm, 4 1/8"

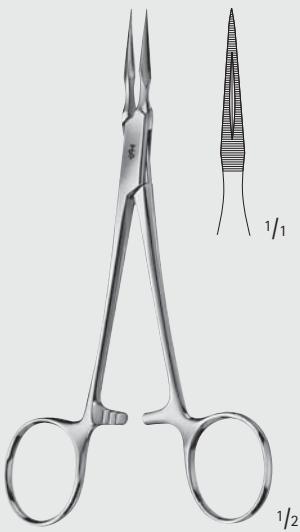

**STIEGLITZ**

**BD992R**

Splitterzange  
Splinter forceps  
140 mm, 5 1/2"

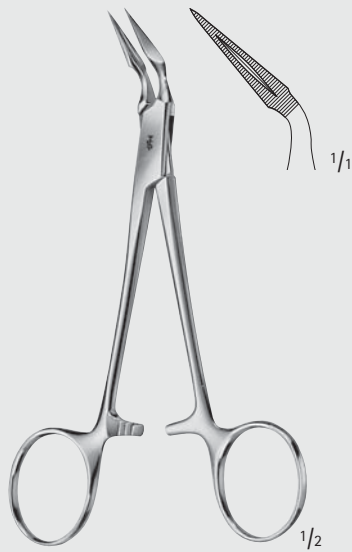

**STIEGLITZ**

**BD993R**

Splitterzange  
Splinter forceps  
140 mm, 5 1/2"

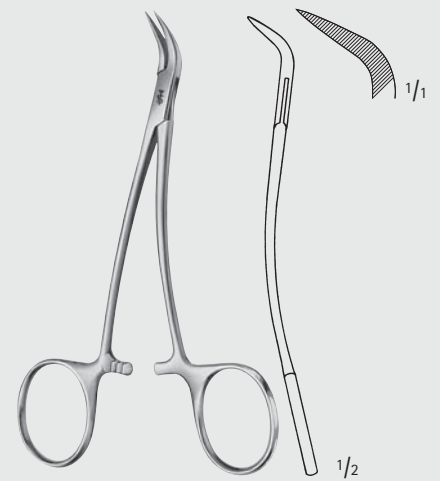

**PEET**

**BD995R**

Splitterzange  
Splinter forceps  
120 mm, 4 3/4"

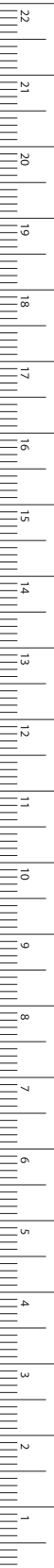

MILLIMETERS

# Chalazion Forceps

OC231R



Chalazion Forceps, 90 mm (3 1/2"), width: 21 mm, non-sterile, reusable

Product search type: Chalazion Forceps  
Aesculap Product Groups: General Surgical Instruments  
Length: 90.00 mm  
Length (Inch): 3 1/2  
Width (mm): 21.000 mm  
Surgical Step: Diss.-Tiss-Dress, Tiss Forceps  
Data Matrix: Yes  
Product contains Latex: No  
Sterility: non-sterile  
Disposable / Reusable: reusable

**По вопросам продаж и поддержки обращайтесь:**

Алматы (7273)495-231	Казань (843)206-01-48	Новокузнецк (3843)20-46-81	Смоленск (4812)29-41-54
Архангельск (8182)63-90-72	Калининград (4012)72-03-81	Новосибирск (383)227-86-73	Сочи (862)225-72-31
Астрахань (8512)99-46-04	Калуга (4842)92-23-67	Омск (3812)21-46-40	Ставрополь (8652)20-65-13
Барнаул (3852)73-04-60	Кемерово (3842)65-04-62	Орел (4862)44-53-42	Сургут (3462)77-98-35
Белгород (4722)40-23-64	Киров (8332)68-02-04	Оренбург (3532)37-68-04	Тверь (4822)63-31-35
Брянск (4832)59-03-52	Краснодар (861)203-40-90	Пенза (8412)22-31-16	Томск (3822)98-41-53
Владивосток (423)249-28-31	Красноярск (391)204-63-61	Пермь (342)205-81-47	Тула (4872)74-02-29
Волгоград (844)278-03-48	Курск (4712)77-13-04	Ростов-на-Дону (863)308-18-15	Тюмень (3452)66-21-18
Вологда (8172)26-41-59	Липецк (4742)52-20-81	Рязань (4912)46-61-64	Ульяновск (8422)24-23-59
Воронеж (473)204-51-73	Магнитогорск (3519)55-03-13	Самара (846)206-03-16	Уфа (347)229-48-12
Екатеринбург (343)384-55-89	Москва (495)268-04-70	Санкт-Петербург (812)309-46-40	Хабаровск (4212)92-98-04
Иваново (4932)77-34-06	Мурманск (8152)59-64-93	Саратов (845)249-38-78	Челябинск (351)202-03-61
Ижевск (3412)26-03-58	Набережные Челны (8552)20-53-41	Севастополь (8692)22-31-93	Череповец (8202)49-02-64
Иркутск (395)279-98-46	Нижний Новгород (831)429-08-12	Симферополь (3652)67-13-56	Ярославль (4852)69-52-93
Россия (495)268-04-70	Киргизия (996)312-96-26-47	Казахстан (7172)727-132	