

Технические характеристики

По вопросам продаж и поддержки обращайтесь:

| | | | |
|-----------------------------|---------------------------------|--------------------------------|---------------------------|
| Алматы (7273)495-231 | Казань (843)206-01-48 | Новокузнецк (3843)20-46-81 | Смоленск (4812)29-41-54 |
| Архангельск (8182)63-90-72 | Калининград (4012)72-03-81 | Новосибирск (383)227-86-73 | Сочи (862)225-72-31 |
| Астрахань (8512)99-46-04 | Калуга (4842)92-23-67 | Омск (3812)21-46-40 | Ставрополь (8652)20-65-13 |
| Барнаул (3852)73-04-60 | Кемерово (3842)65-04-62 | Орел (4862)44-53-42 | Сургут (3462)77-98-35 |
| Белгород (4722)40-23-64 | Киров (8332)68-02-04 | Оренбург (3532)37-68-04 | Тверь (4822)63-31-35 |
| Брянск (4832)59-03-52 | Краснодар (861)203-40-90 | Пенза (8412)22-31-16 | Томск (3822)98-41-53 |
| Владивосток (423)249-28-31 | Красноярск (391)204-63-61 | Пермь (342)205-81-47 | Тула (4872)74-02-29 |
| Волгоград (844)278-03-48 | Курск (4712)77-13-04 | Ростов-на-Дону (863)308-18-15 | Тюмень (3452)66-21-18 |
| Вологда (8172)26-41-59 | Липецк (4742)52-20-81 | Рязань (4912)46-61-64 | Ульяновск (8422)24-23-59 |
| Воронеж (473)204-51-73 | Магнитогорск (3519)55-03-13 | Самара (846)206-03-16 | Уфа (347)229-48-12 |
| Екатеринбург (343)384-55-89 | Москва (495)268-04-70 | Санкт-Петербург (812)309-46-40 | Хабаровск (4212)92-98-04 |
| Иваново (4932)77-34-06 | Мурманск (8152)59-64-93 | Саратов (845)249-38-78 | Челябинск (351)202-03-61 |
| Ижевск (3412)26-03-58 | Набережные Челны (8552)20-53-41 | Севастополь (8692)22-31-93 | Череповец (8202)49-02-64 |
| Иркутск (395)279-98-46 | Нижний Новгород (831)429-08-12 | Симферополь (3652)67-13-56 | Ярославль (4852)69-52-93 |
| Россия (495)268-04-70 | Киргизия (996)312-96-26-47 | Казахстан (7172)727-132 | |

Knochenhaltezeugen, Hohlmeißelzangen – Bone Holding Forceps, Bone Rongeurs

Distraktor, Repositionszangen

Distractor, Reposition Forceps

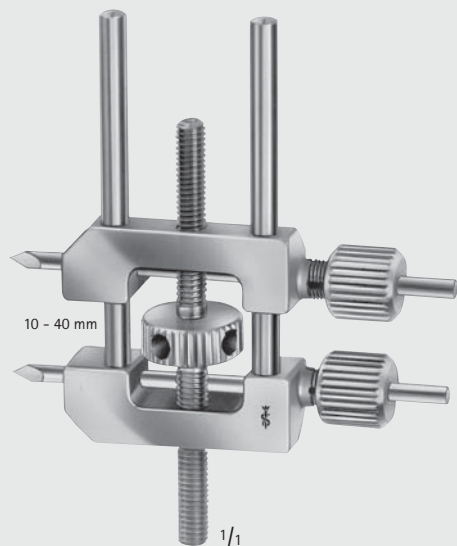

LX310R

Kleiner Distraktor, zum Distrahieren und Komprimieren von kleinen Knochen, für Bohrdrähte Ø 3,0 mm
Small distractor, a repositioning device for distraction and compression of small bones, for wires with 3.0 mm diam.

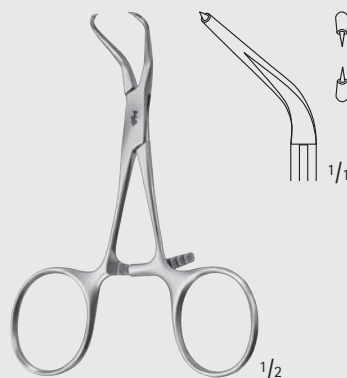

F0113R

Repositionszange mit abgesetzten Spitzen
Reposition forceps with stepped tips
95 mm, 3 3/4"

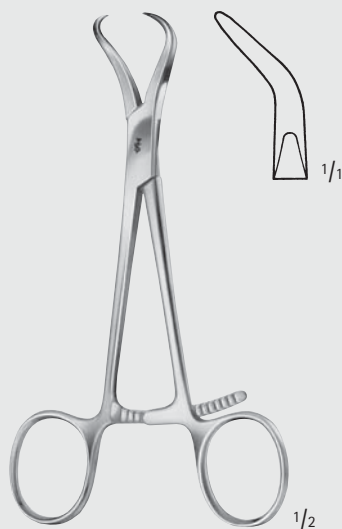

F0115R

Repositionszange für Kleinfragmente
Reposition forceps for small fragments
135 mm, 5 1/4"

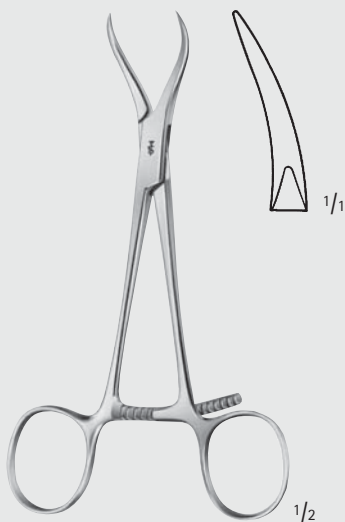

F0117R

Repositionszange, speziell für Kieferrepositionen
Reposition forceps, especially for maxillary reposition
135 mm, 5 1/4"



HAASE

F0119R

Repositionszange für Unterkieferfrakturen
Reposition forceps for mandibular fractures
165 mm, 6 1/2"

FO



INCHES



Knochenhaltezangen, Hohlmeißelzangen – Bone Holding Forceps, Bone Rongeurs

Repositionszangen, Repositionsstößel

Reposition Forceps, Reposition Tamper



Zum Fixieren eines anzuschraubenden Knochenteils mittels KIRSCHNER-Bohrdraht bis Ø 2 mm
A bone part to be screwed on is fixed by using a KIRSCHNER wire up to diam. 2 mm

WÖRRLEIN

FO105R

Repositionsstößel (Kronenspieß), längsdurchbohrt
Reposition tamper, cannulated
165 mm, 6 1/2"

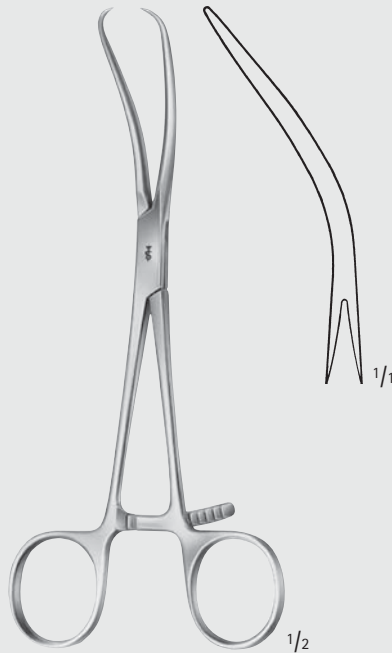

REILL

FO116R

Repositionszange
Reposition forceps
170 mm, 6 3/4"

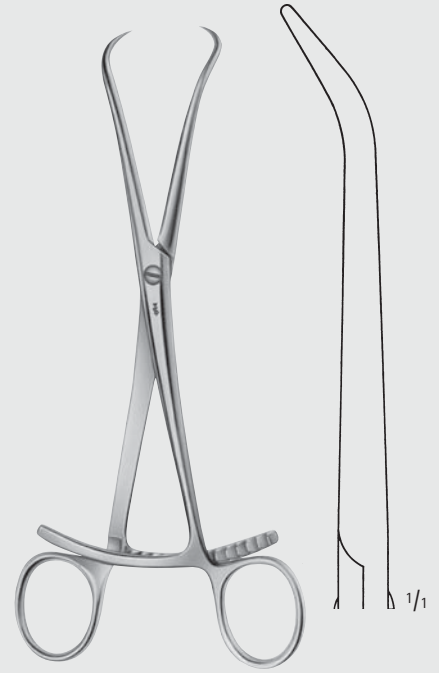

FO118R

Repositionszange
Reposition forceps
205 mm, 8"

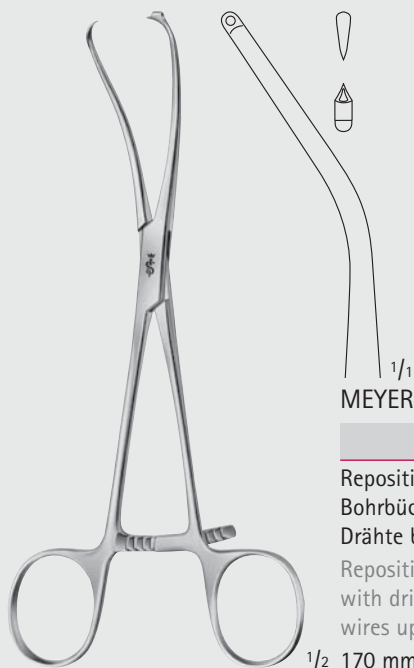

MEYER

FO106R

Repositionszange für Finger, mit Bohrbüchse für KIRSCHNER-Drähte bis Ø 1 mm
Reposition forceps for fingers, with drill guide for KIRSCHNER wires up to diam. 1 mm
170 mm, 6 3/4"

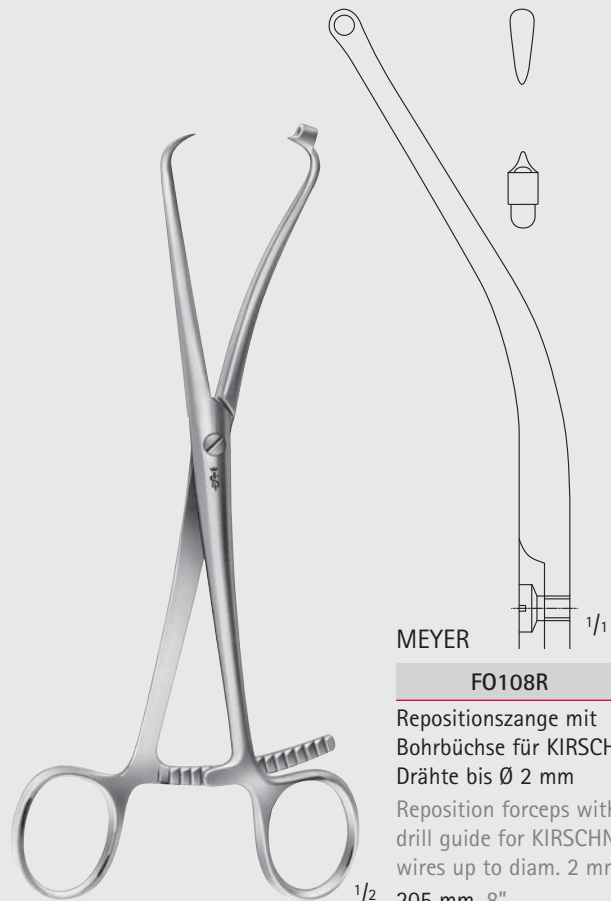

MEYER

FO108R

Repositionszange mit Bohrbüchse für KIRSCHNER-Drähte bis Ø 2 mm
Reposition forceps with drill guide for KIRSCHNER wires up to diam. 2 mm
205 mm, 8"

FO

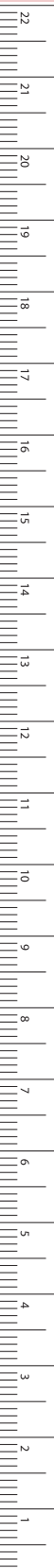

MILLIMETERS

Knochenhalte­zangen, Hohl­meißel­zangen – Bone Holding Forceps, Bone Rongeurs

Reposition­zangen, Knochen­halte­zangen
 Reposition Forceps, Bone Holding Forceps

FO



FO153R

Patellazange
 Patella forceps
 185 mm, 7 1/4"



FO112R

Knöchelfasszange
 Malleolar forceps
 210 mm, 8 1/4"



FO123R

Zange mit Zahnsperre
 Forceps with ratchet fixation
 140 mm, 5 1/2"



FO124R

Zange mit Gewindesperre
 Forceps with thread fixation
 170 mm, 6 3/4"



FO125R

Zange mit Gewindesperre
 Forceps with thread fixation
 235 mm, 9 1/4"



Knochenhaltezangen, Hohlmeißelzangen – Bone Holding Forceps, Bone Rongeurs

Knochenhaltezangen Bone Holding Forceps



DINGMANN

FO110R

185 mm, 7 1/4"

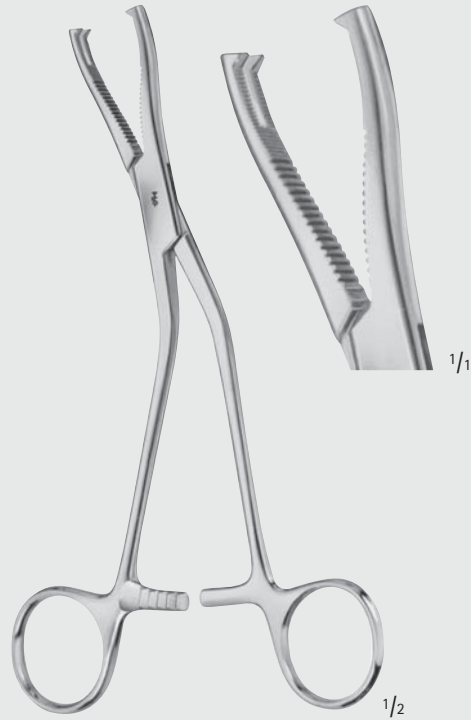

DINGMANN, MODIF.

FO111R

185 mm, 7 1/4"



FO100R

Sequesterzange
Sequestrum forceps
200 mm, 8"

FO

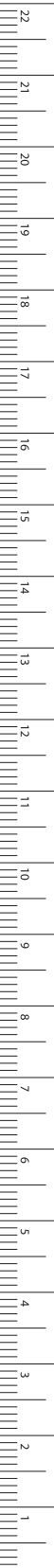

MILLIMETERS

Knochenhaltezangen, Hohlmeißelzangen – Bone Holding Forceps, Bone Rongeurs

Knochenhaltezangen
Bone Holding Forceps

FO



5 mm

M 1/1



FO120R

200 mm, 8"

11 mm

M 1/1



LANGENBECK

FO127R

205 mm, 8"

12 mm

M 1 1/1



FERGUSSON

FO130R

205 mm, 8"

8 mm



SEMB

FO135R

190 mm, 7 1/2"

8 mm



SEMB

FO136R

190 mm, 7 1/2"



Knochenhaltezangen, Hohlmeißelzangen – Bone Holding Forceps, Bone Rongeurs

Knochenhaltezangen Bone Holding Forceps

FO

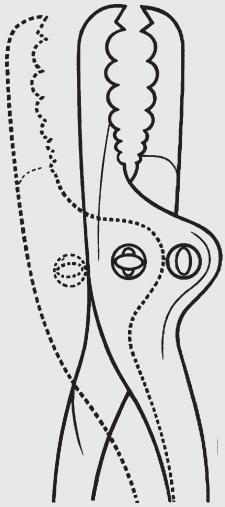

im Maul verstellbar
jaw adjustable



FARABEUF

FO140R

230 mm, 9"



FARABEUF

FO141R

255 mm, 10"



FARABEUF-LAMBOTTE

FO143R

255 mm, 10"



MILLIMETERS

Knochenhaltezangen, Hohlmeißelzangen – Bone Holding Forceps, Bone Rongeurs
Knochenhaltezangen
Bone Holding Forceps

FO

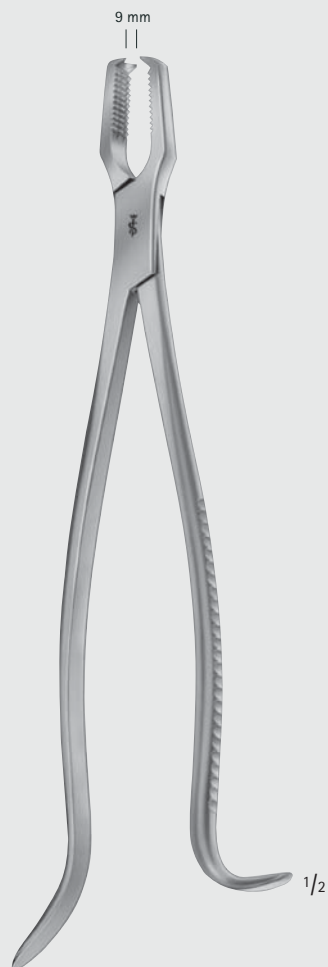

KERN-LANE

FO150R

240 mm, 9 1/2"

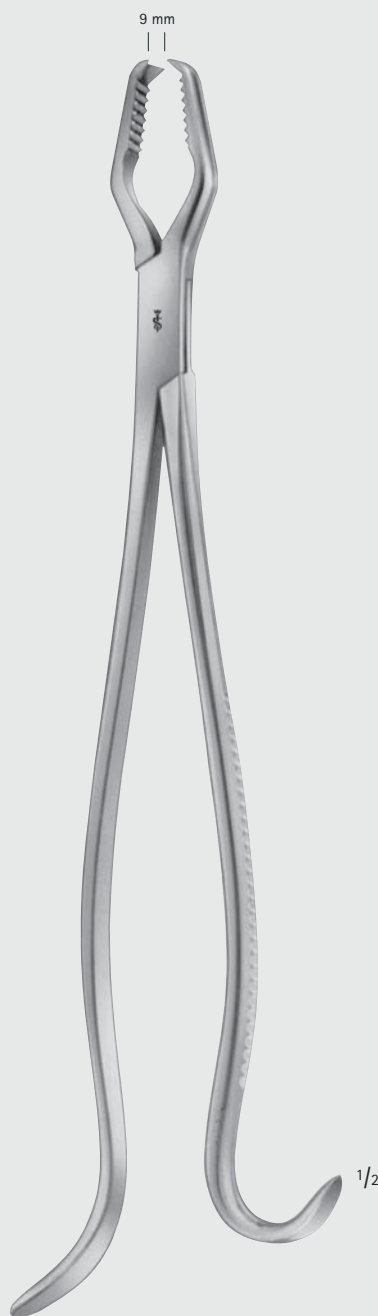

LANE

FO151R

330 mm, 13 1/8"



Knochenhaltezangen, Hohlmeißelzangen – Bone Holding Forceps, Bone Rongeurs

Knochenhaltezangen Bone Holding Forceps

FO



KERN-MINI

FO148R

155 mm, 6"



KERN-LANE

FO158R

240 mm, 9 1/2"



LANE

FO159R

320 mm, 12 3/4"



Knochenhaltezangen, Hohlmeißelzangen – Bone Holding Forceps, Bone Rongeurs

Knochenhaltezangen
Bone Holding Forceps

FO



HEY GROVES

FO144R

210 mm, 8 1/4"



HEY GROVES

FO145R

270 mm, 10 3/4"



HEY GROVES

FO146R

305 mm, 12"



Knochenhaltezangen, Hohlmeißelzangen – Bone Holding Forceps, Bone Rongeurs

Knochenhaltezangen Bone Holding Forceps

FO

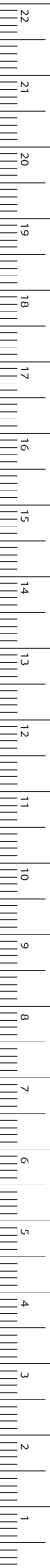

FO169R-FO173R

selbstzentrierend mit Gewindesperre
self-centering forceps with thread fixation

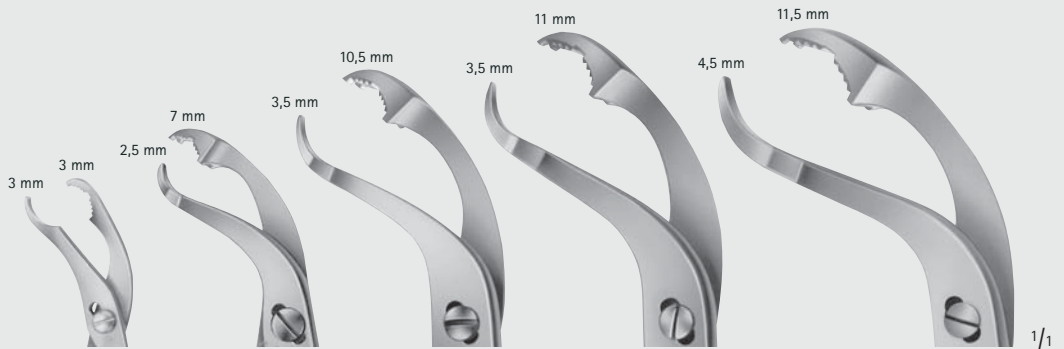

FO169R

145 mm
5 3/4"

für Klein-
fragmente
for small
fragments

Fig. 0

FO170R

190 mm
7 1/2"

Fig. 1

FO171R

240 mm
9 1/2"

Fig. 2

FO172R

260 mm
10 1/4"

Fig. 3

FO173R

280 mm
11"



VERBRUGGE

FO180R

175 mm, 7"

extra klein
small

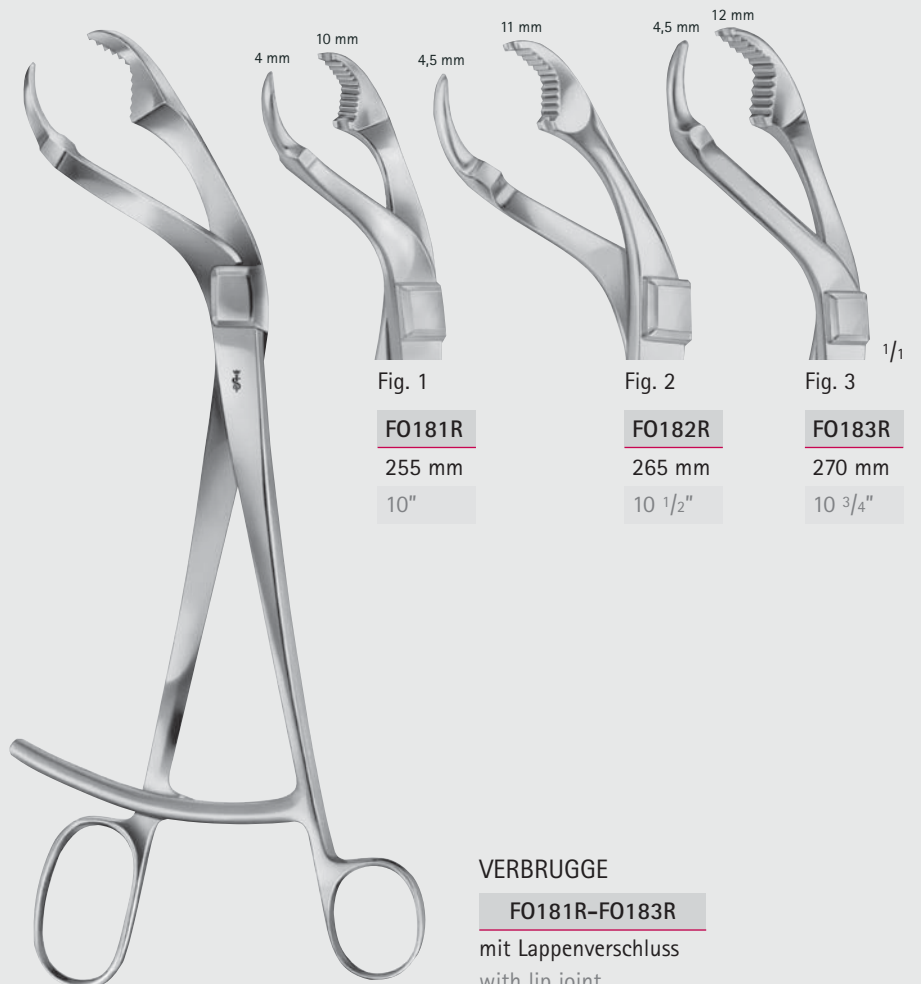

Fig. 1

FO181R

255 mm
10"

Fig. 2

FO182R

265 mm
10 1/2"

Fig. 3

FO183R

270 mm
10 3/4"

VERBRUGGE

FO181R-FO183R

mit Lappenverschluss
with lip joint

MILLIMETERS

Knochenhaltezangen, Hohlmeißelzangen – Bone Holding Forceps, Bone Rongeurs

Knochenhaltezangen
Bone Holding Forceps

FO



Maulteil beweglich
movable jaw



FO160R
220 mm
8 3/4"



FO161R
260 mm
10 1/4"



FO162R
330 mm
13 1/8"

LAMBOTTE

FO160R-FO162R

INCHES



Knochenhaltezangen, Hohlmeißelzangen – Bone Holding Forceps, Bone Rongeurs
 Knochenhalteklammern
 Bone Clamps

FO



LOWMAN

FO190R 170 mm, 6 3/4"

FO191R 205 mm, 8"



LOWMAN-GERSTER

FO192R

210 mm, 8 1/4"



LOWMAN-HOGLUND

FO193R

175 mm, 7"

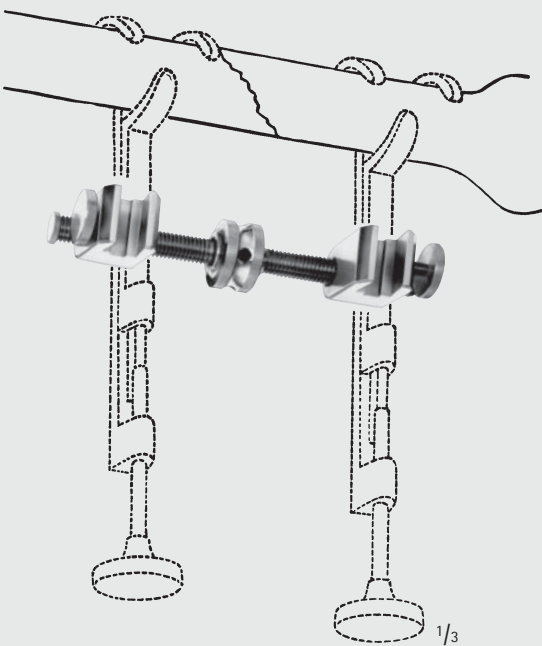

GERSTER

FO199R

Distraktionsklammer für FO190R – FO193R

Traction bar for FO190R – FO193R



LEWIN

MD455

185 mm, 7 1/4"

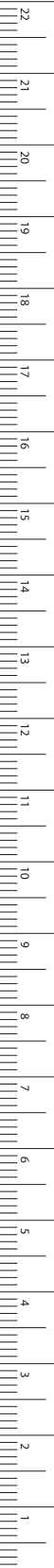

MILLIMETERS

Knochenhaltezangen, Hohlmeißelzangen – Bone Holding Forceps, Bone Rongeurs

Synovektomie-Zangen, Hohlmeißelzangen

Synovectomy-Rongeurs, Bone Rongeurs

FO



FO599R

Synovektomie-Zange
Maulbreite 2 mm
Synovectomy rongeur
jaw width 2 mm
130 mm, 5 1/8"



STELLBRINK

FO399R

Synovektomie-Zange
Synovectomy rongeur
175 mm, 7"



STELLBRINK

FO400R

Synovektomie-Zange
Synovectomy rongeur
170 mm, 6 3/4"



FO408R

Hohlmeißelzangen
Bone rongeurs
145 mm, 5 3/4"

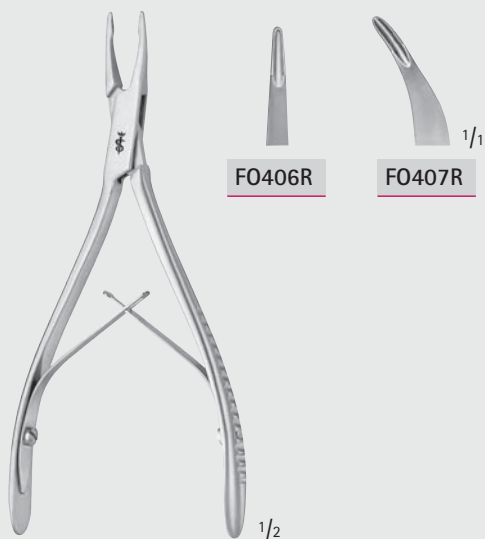

FRIEDMANN

FO406R-FO407R

Hohlmeißelzange
Bone rongeur
140 mm, 5 1/2"



LUER-FRIEDMANN

FO409R

Hohlmeißelzangen
Bone rongeurs
145 mm, 5 3/4"



Knochenhaltezangen, Hohlmeißelzangen – Bone Holding Forceps, Bone Rongeurs
Hohlmeißelzangen
Bone Rongeurs

FO



FO413R

150 mm, 6"



FO410R

140 mm, 5 1/2"

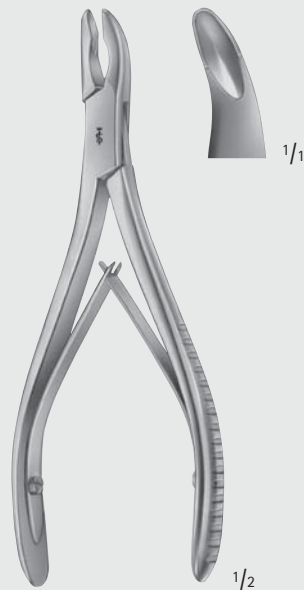

LUER

FO411R

150 mm, 6"

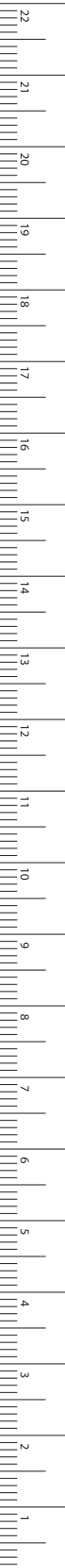

MILLIMETERS

Knochenhaltezangen, Hohlmeißelzangen – Bone Holding Forceps, Bone Rongeurs

Hohlmeißelzangen

Bone Rongeurs

FO

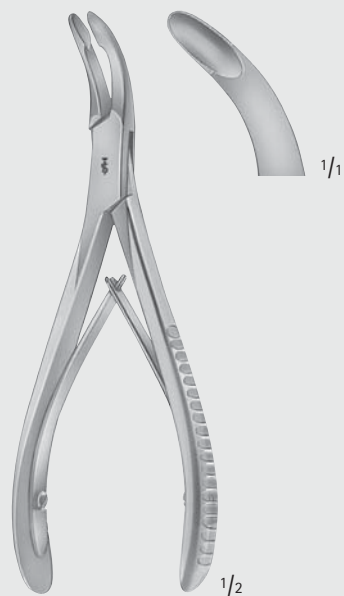

LUER

FO412R

155 mm, 6"



BLUMENTHAL

FO415R

155 mm, 6"



BLUMENTHAL

FO416R

150 mm, 6"



HAKANSSON

FO428R

170 mm, 6 3/4"

1/1
seitwärts
gebogen
curved
to side



JANSEN

FO430R-FO432R

175 mm, 7"

FO430R

FO432R

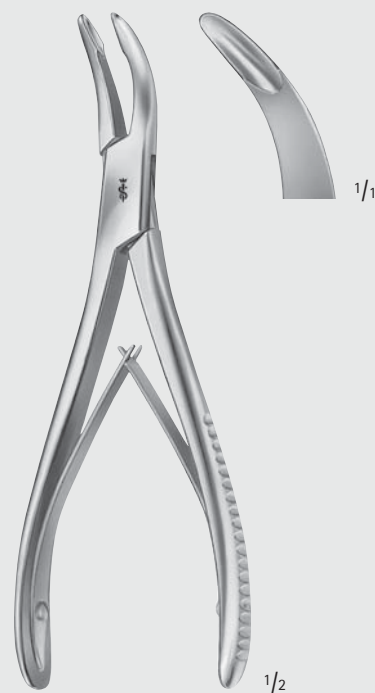

BANE-HARTMANN

FO457R

175 mm, 7"



Knochenhaltezangen, Hohlmeißelzangen – Bone Holding Forceps, Bone Rongeurs
 Hohlmeißelzangen
 Bone Rongeurs

FO



ALEXANDER

FO440R

140 mm, 5 1/2"

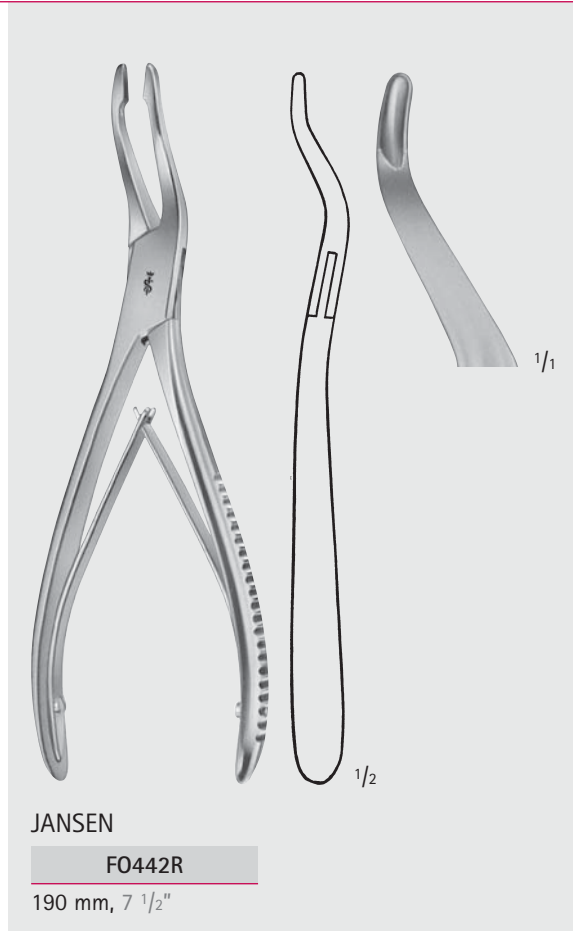

JANSEN

FO442R

190 mm, 7 1/2"

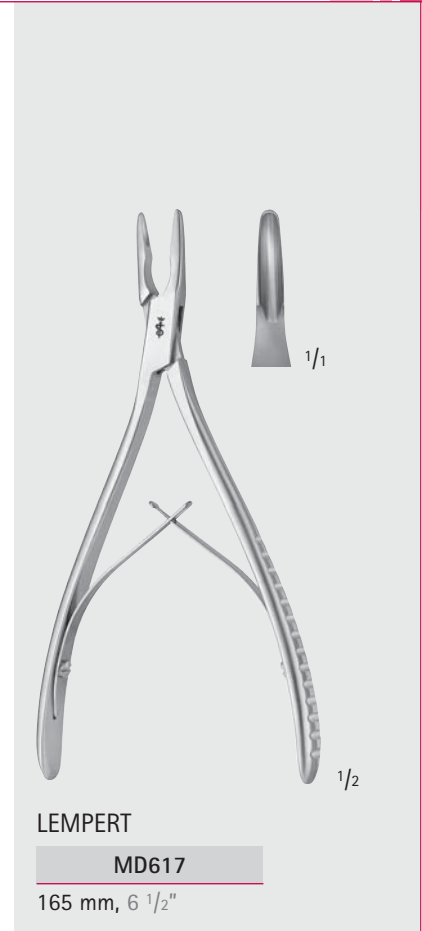

LEMPERT

MD617

165 mm, 6 1/2"

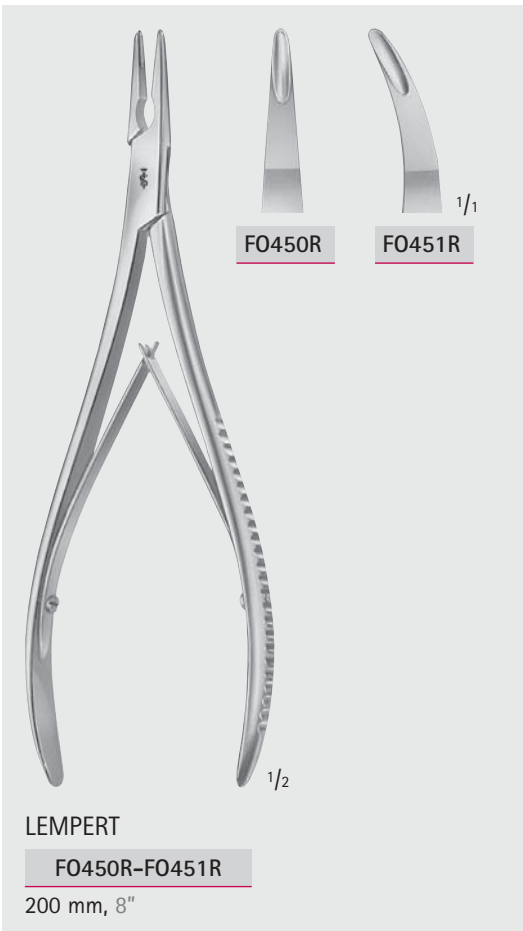

LEMPERT

FO450R-FO451R

200 mm, 8"

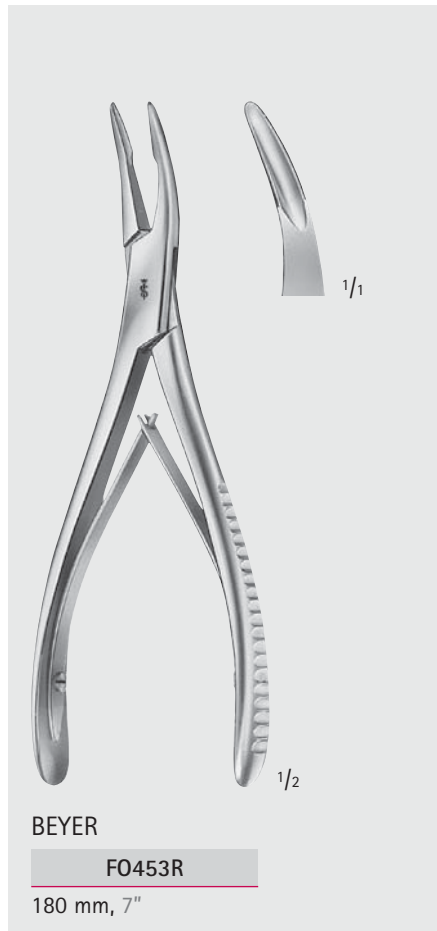

BEYER

FO453R

180 mm, 7"

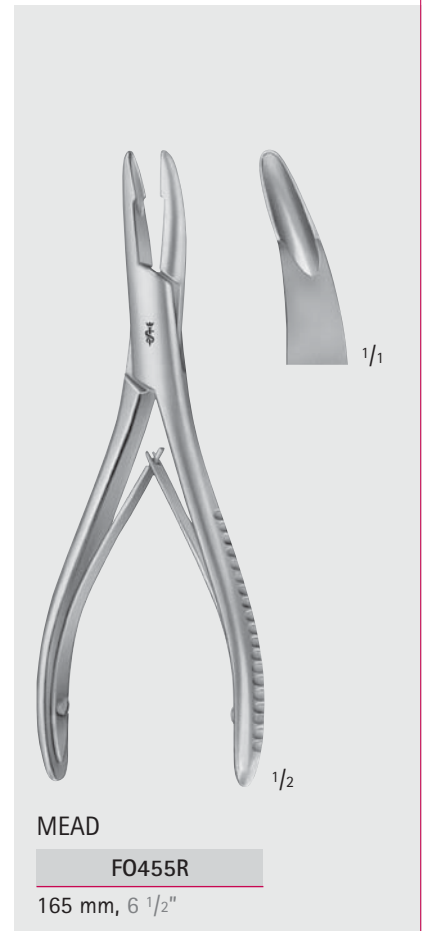

MEAD

FO455R

165 mm, 6 1/2"

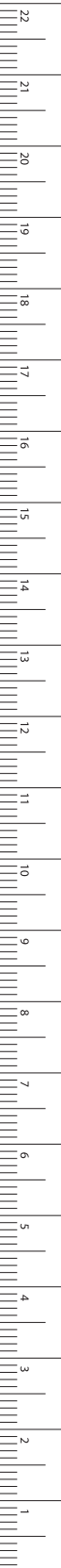

MILLIMETERS

Knochenhaltezangen, Hohlmeißelzangen – Bone Holding Forceps, Bone Rongeurs

Hohlmeißelzangen

Bone Rongeurs

FO

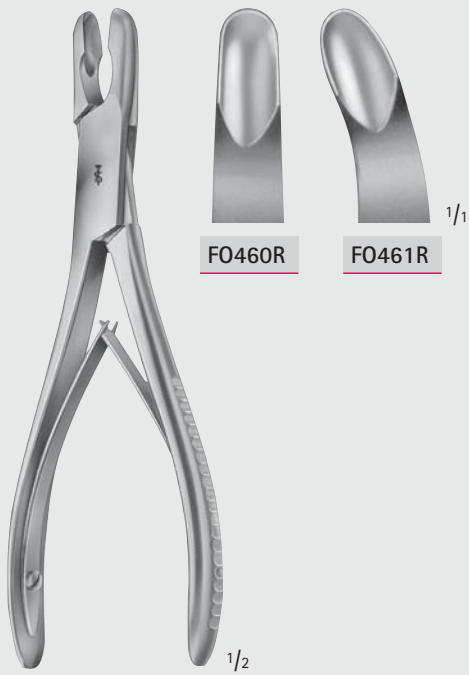

FO460R

FO461R

1/1

1/2

LUER

FO460R-FO461R

175 mm, 7"



LUER

FO462R

180 mm, 7"

1/2

1/1



LUER

FO463R

180 mm, 7"

1/2

1/1



OLIVECRONA

FO470R

205 mm, 8"

1/2

1/1



GULEKE

FO472R

205 mm, 8"

1/2

1/1



TROTTER

FO467R

205 mm, 8"

1/2

seitwärts
gebogen
curved
to side

1/1



Knochenhaltezangen, Hohlmeißelzangen – Bone Holding Forceps, Bone Rongeurs
Hohlmeißelzangen
Bone Rongeurs

FO

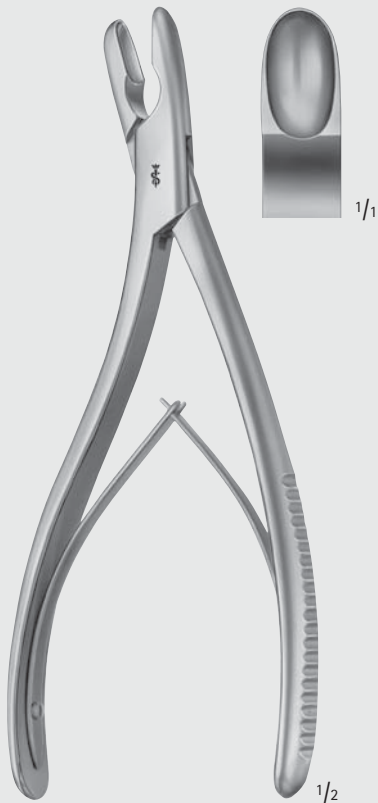
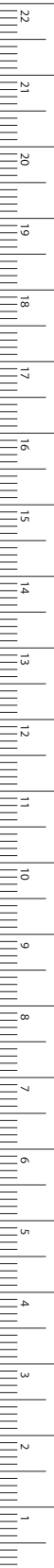

NORTHFIELD
FO474R
210 mm, 8 1/4"

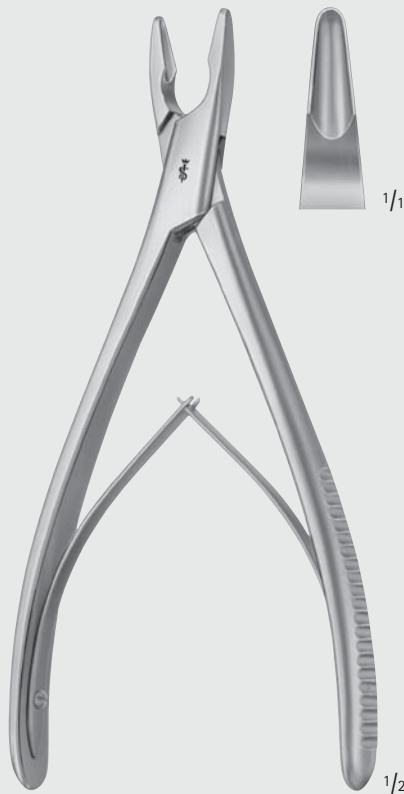

PENNYBACKER
FO475R
205 mm, 8"

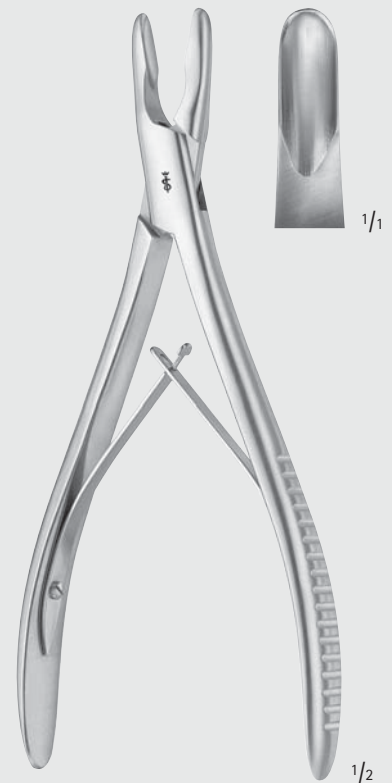

ADSON
MD615
200 mm, 8"

MILLIMETERS

Knochenhaltezangen, Hohlmeißelzangen – Bone Holding Forceps, Bone Rongeurs

Hohlmeißelzangen

Bone Rongeurs

FO

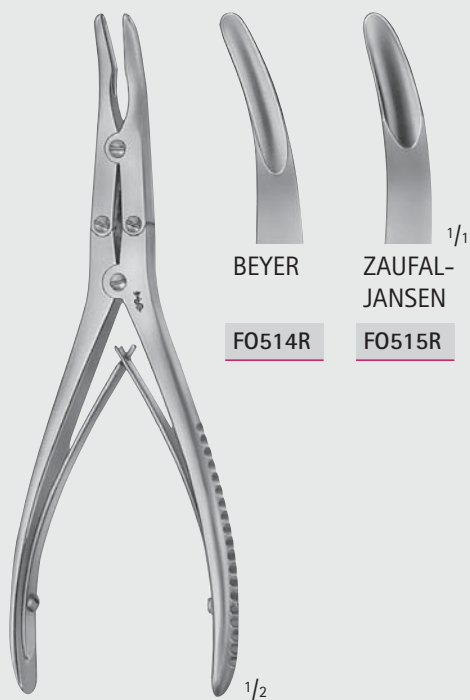
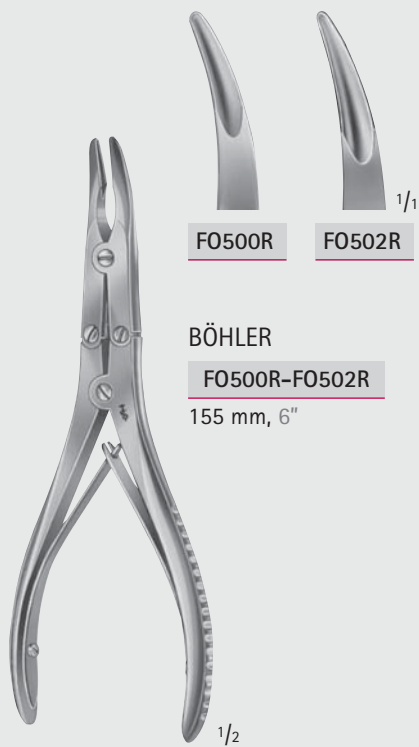

FO514R-FO515R
180 mm, 7"



RUSKIN
FO518R
190 mm, 7 1/2"



RÖTTGEN-RUSKIN
FO521R
240 mm, 9 1/2"



Knochenhaltezangen, Hohlmeißelzangen – Bone Holding Forceps, Bone Rongeurs
 Hohlmeißelzangen
 Bone Rongeurs

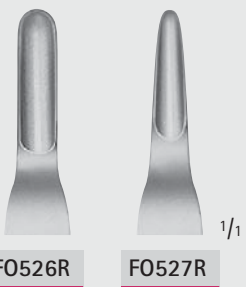

LEKSELL
FO526R-FO527R
 245 mm, 9 3/4"



ECHLIN
FO522R-FO523R
 230 mm, 9"



FRYKHOLM
FO525R
 240 mm, 9 1/2"

FO

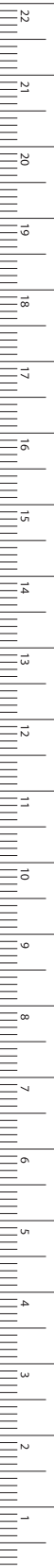

Knochenhaltezangen, Hohlmeißelzangen – Bone Holding Forceps, Bone Rongeurs

Hohlmeißelzangen

Bone Rongeurs

FO



STILLE

FO530R

235 mm, 9 1/4"



LEKSELL-STILLE

FO532R

240 mm, 9 1/2"

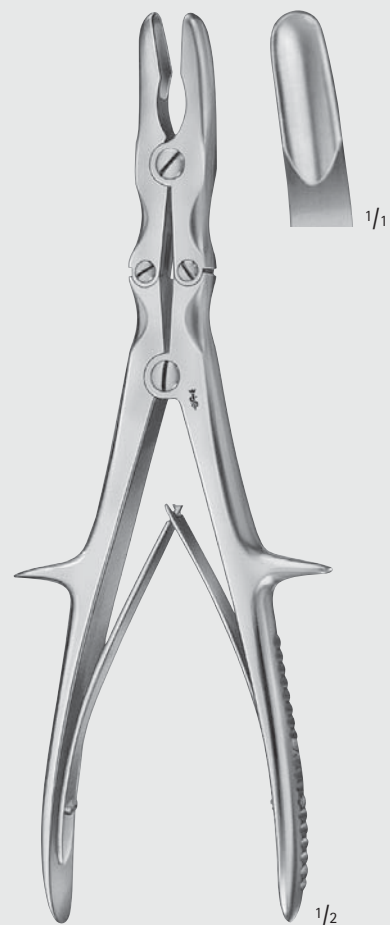

STILLE-RUSKIN

FO534R

240 mm, 9 1/2"



Knochenhaltezangen, Hohlmeißelzangen – Bone Holding Forceps, Bone Rongeurs
Hohlmeißelzangen
Bone Rongeurs

FO



LUER-STILLE

FO550R

225 mm, 9"



LUER-STILLE

FO551R

225 mm, 9"

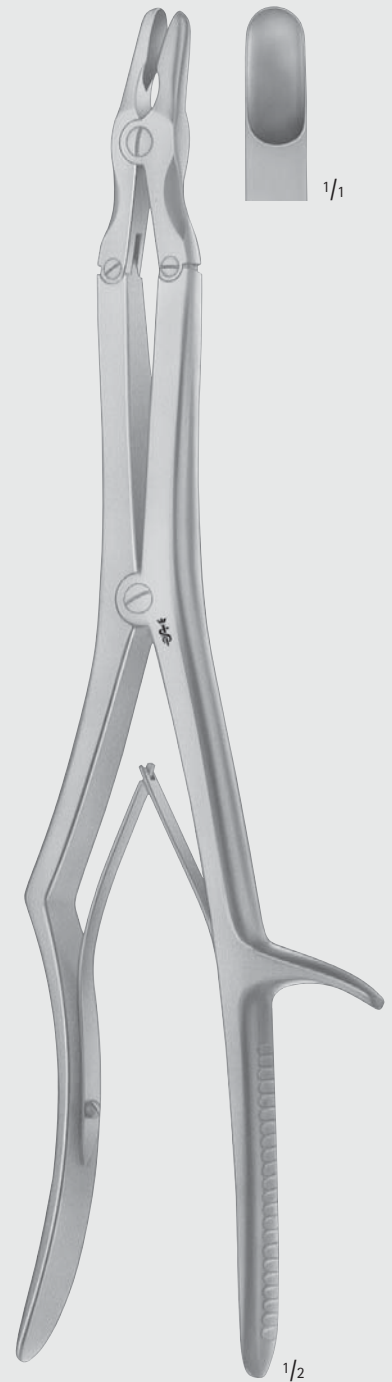

SYPERT

FG052R

360 mm, 14 1/2"



MILLIMETERS

Knochenhaltezangen, Hohlmeißelzangen – Bone Holding Forceps, Bone Rongeurs
Hohlmeißelzangen
Bone Rongeurs

FO



LUER-STILLE

FO566R

270 mm, 10 3/4"



SEMB

FO555R

240 mm, 9 1/2"



Knochenhaltezangen, Hohlmeißelzangen – Bone Holding Forceps, Bone Rongeurs
Hohlmeißelzangen
Bone Rongeurs

FO



1/2



FO570R



FO572R

1/1

SAUERBRUCH-CORYLLOS

FO570R-FO572R

310 mm, 12 3/8"



MILLIMETERS

Knochenhaltezangen, Hohlmeißelzangen – Bone Holding Forceps, Bone Rongeurs
 Knochensplitterzangen
 Bone Cutting Forceps

FO

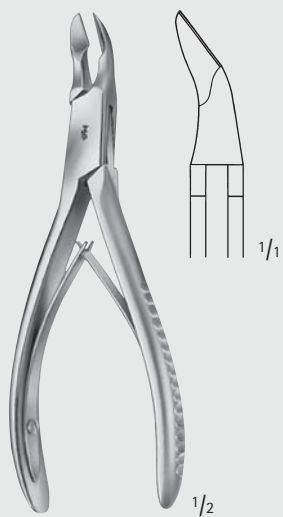

FO601R
 130 mm, 5 1/8"



STAMM
FO604R
 150 mm, 6"

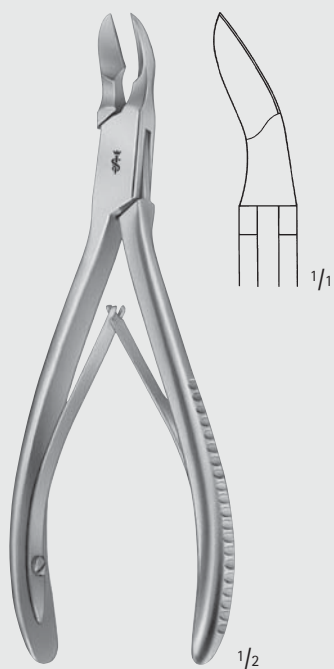

FO602R
 170 mm, 6 3/4"

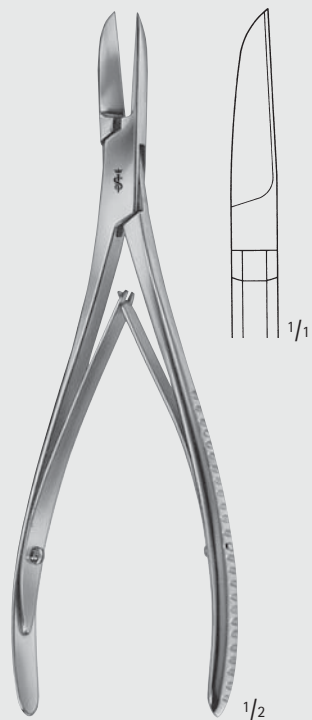

KAZANJIAN
OK378R
 185 mm, 7 1/2"



Knochenhaltezangen, Hohlmeißelzangen – Bone Holding Forceps, Bone Rongeurs
Knochensplitterzangen
Bone Cutting Forceps

FO

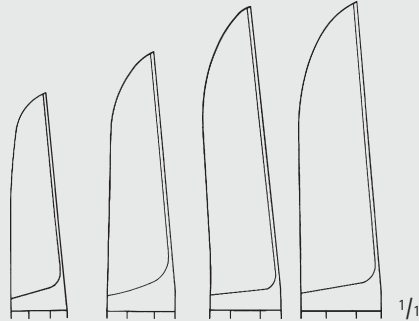

| FO620R | FO622R | FO624R | FO626R |
|--------|--------|--------|--------|
| 140 mm | 170 mm | 200 mm | 220 mm |
| 5 1/2" | 6 3/4" | 8" | 8 3/4" |

LISTON

FO620R-FO626R

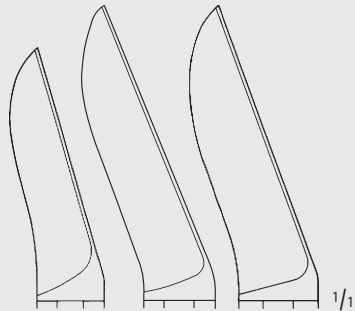

| FO632R | FO634R | FO636R |
|--------|--------|--------|
| 170 mm | 200 mm | 220 mm |
| 6 3/4" | 8" | 8 3/4" |

LISTON

FO632R-FO636R

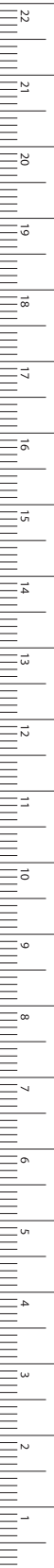

MILLIMETERS

Knochenhaltezangen, Hohlmeißelzangen – Bone Holding Forceps, Bone Rongeurs
 Knochensplitterzangen
 Bone Cutting Forceps

FO

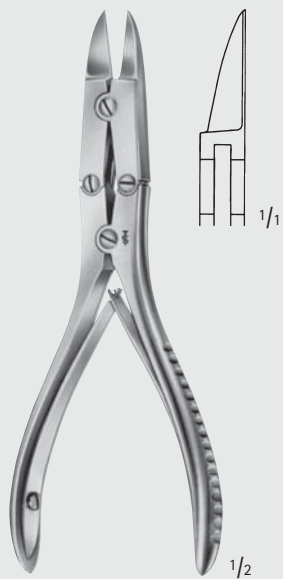

BÖHLER

FO610R

145 mm, 5 3/4"



BÖHLER

FO611R

145 mm, 5 3/4"



FO612R

170 mm, 6 3/4"



MC INDOE

FO614R

175 mm, 7"



RUSKIN-LISTON

FO640R

190 mm, 7 1/2"



RUSKIN-LISTON

FO641R

190 mm, 7 1/2"

INCHES



Knochenhaltezangen, Hohlmeißelzangen – Bone Holding Forceps, Bone Rongeurs
Knochensplitterzangen
Bone Cutting Forceps

FO

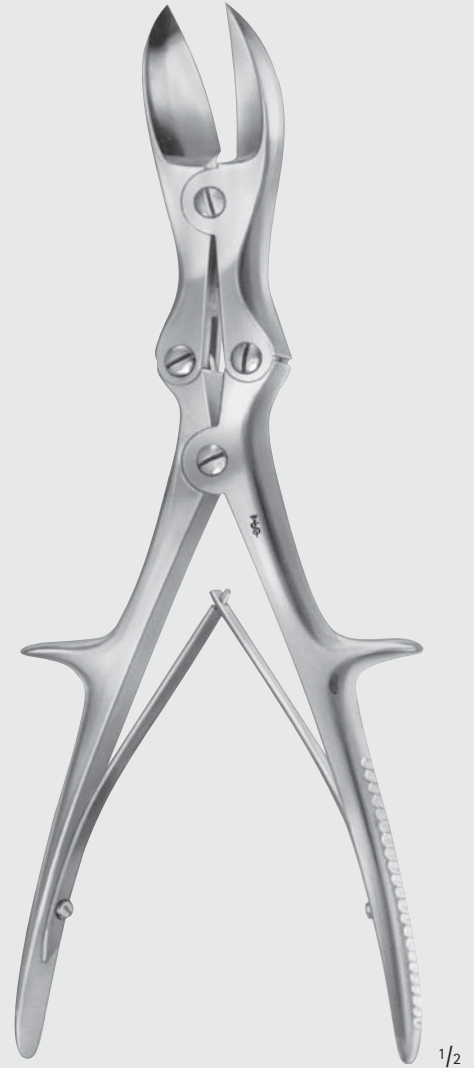
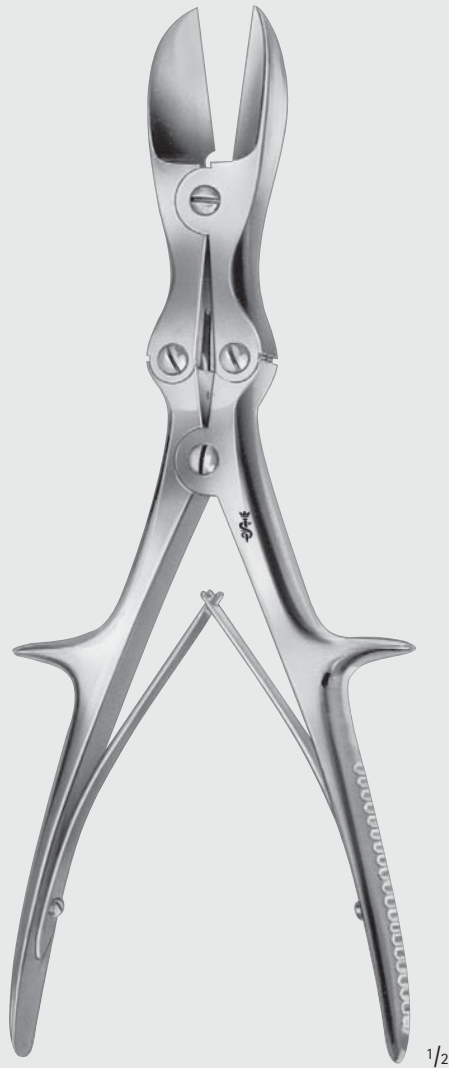
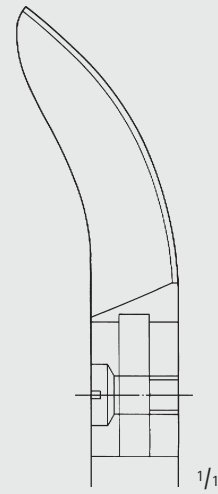
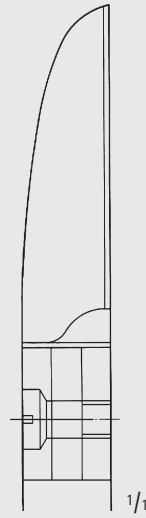
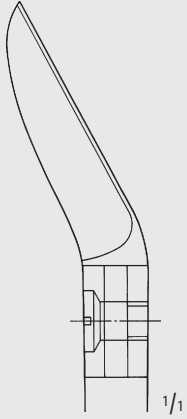

LISTON

FO645R

aufgebogen
curved on flat
240 mm, 9 1/2"

LISTON

FO646R

gerade
straight
280 mm, 11"

LISTON

FO647R

aufgebogen
curved on flat
280 mm, 11"



MILLIMETERS

Knochenhaltezangen, Hohlmeißelzangen – Bone Holding Forceps, Bone Rongeurs
 Knochensplitterzangen
 Bone Cutting Forceps

FO

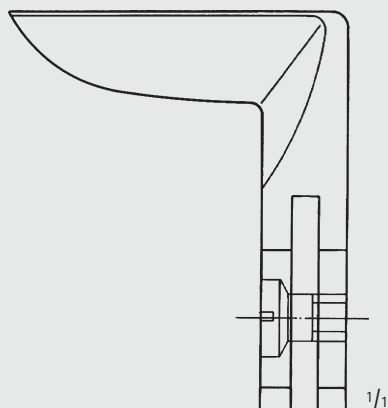

LISTON-STILLE

FO648R

265 mm, 10 1/2"

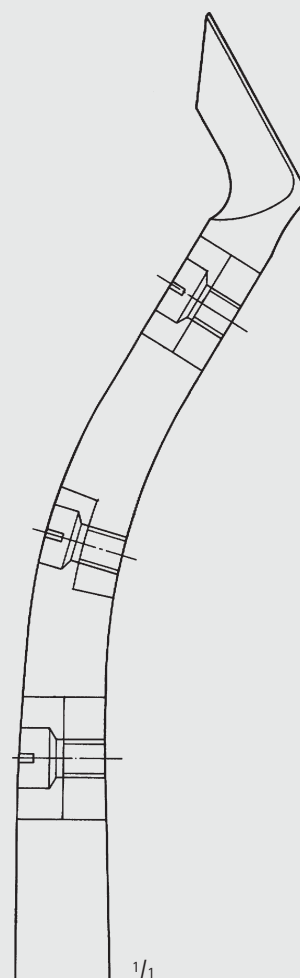
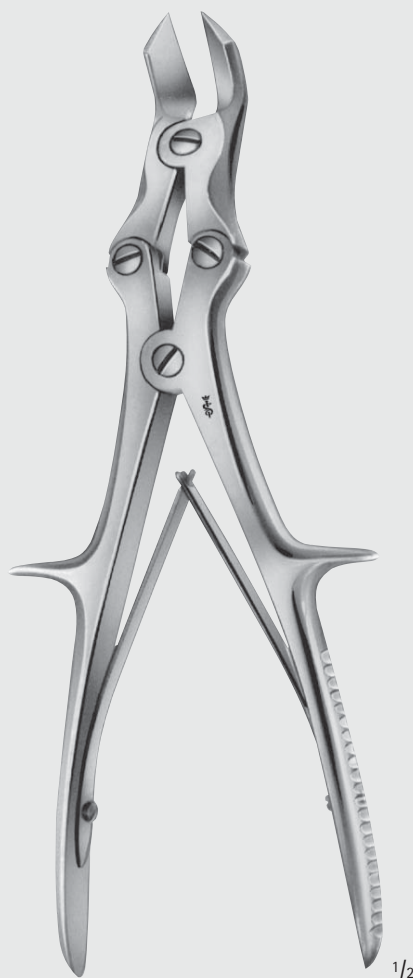

LISTON-KEY-HORSLEY
 (TUDOR EDWARDS)

FO649R

255 mm, 10"



Knochenhaltezangen, Hohlmeißelzangen – Bone Holding Forceps, Bone Rongeurs
 Meniskus- und Knorpelzangen
 Meniscus- and Cartilage Forceps

FO

BIRCHER
FO800R
 200 mm, 8"

BIRCHER
FO801R
 200 mm, 8"

WELLER
FO807R
 200 mm, 8"

BIRCHER-GANSKE
FO808R
 200 mm, 8"

BIRCHER-GANSKE
FO810R
 200 mm, 8"

MARTIN
FO816R
 205 mm, 8"



Knochenhaltezangen, Hohlmeißelzangen – Bone Holding Forceps, Bone Rongeurs

Meniskusmesser

Meniscus Knives

FO

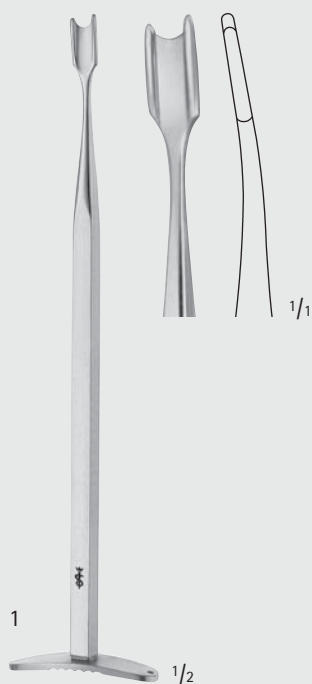

SMILLIE

FO855R

170 mm, 6 3/4"

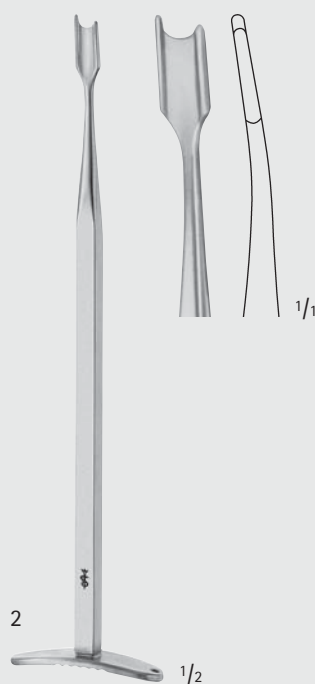

SMILLIE

FO856R

170 mm, 6 3/4"

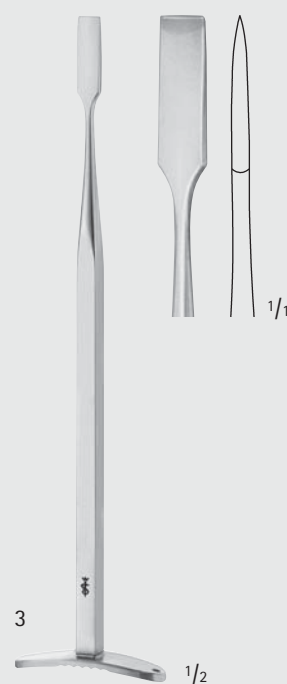

SMILLIE

FO857R

170 mm, 6 3/4"



Knochenhaltezangen, Hohlmeißelzangen – Bone Holding Forceps, Bone Rongeurs
 Wund- und Meniskushaken
 Retractors and Knee Retractors

FO

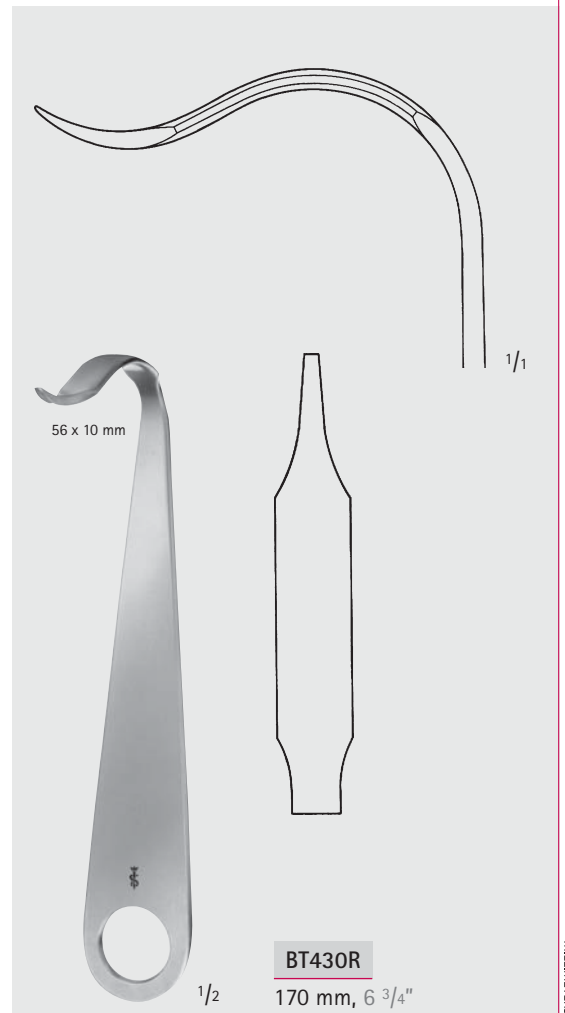
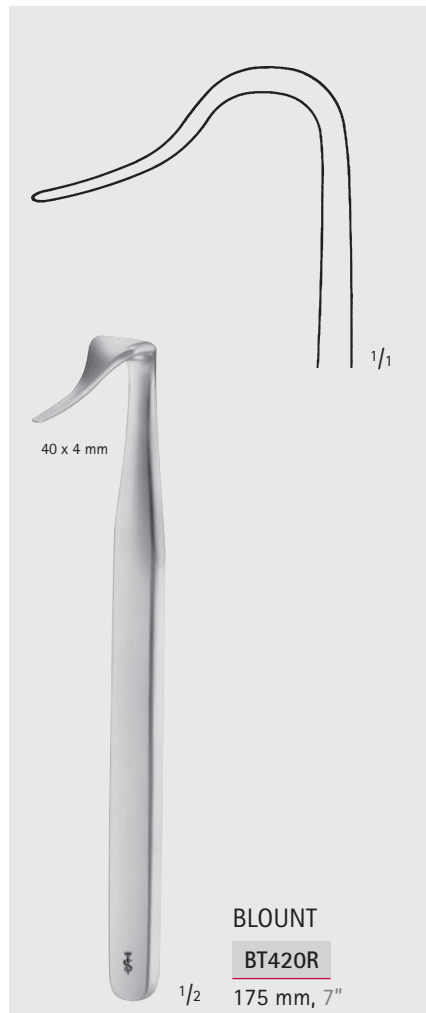
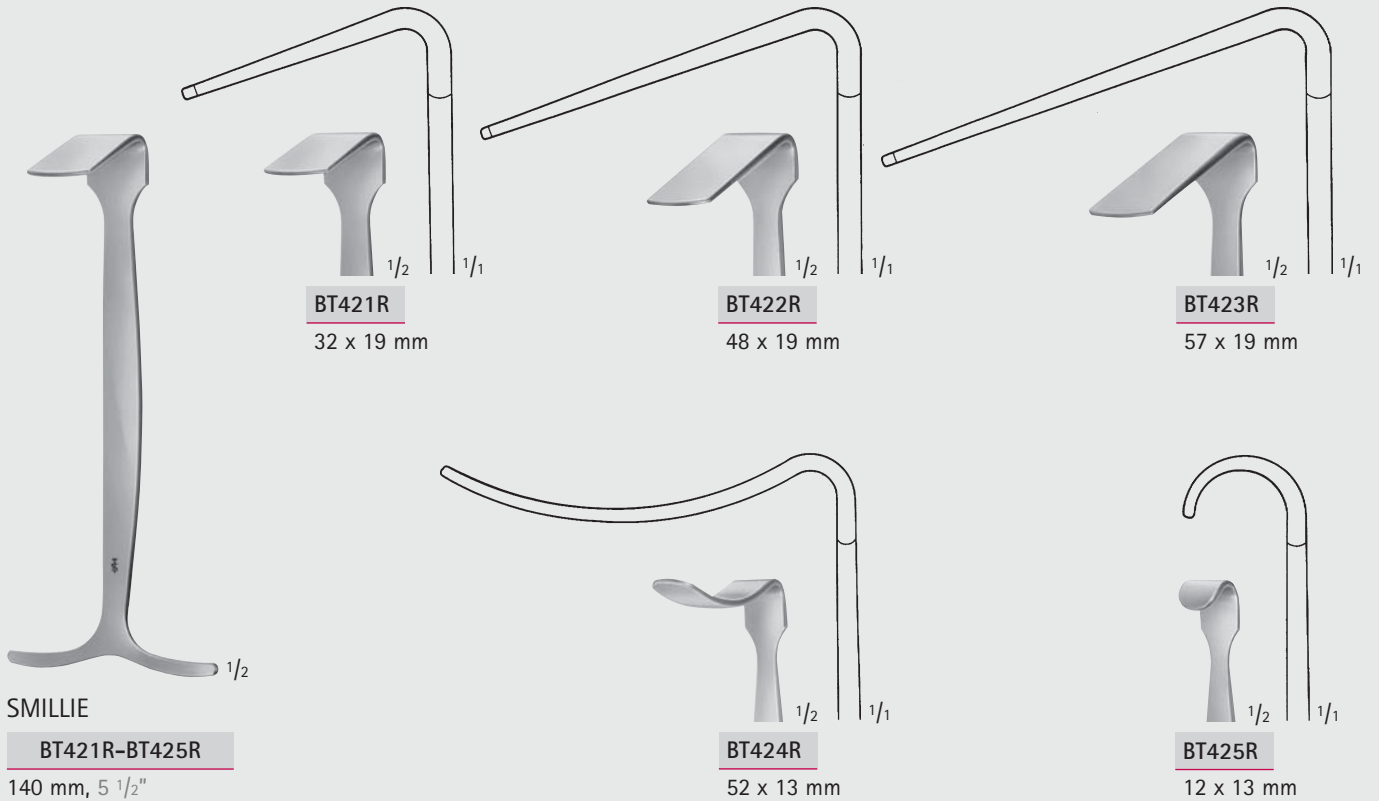
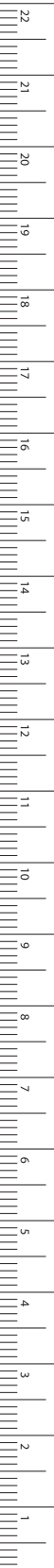

MILLIMETERS

Knochenhaltezangen, Hohlmeißelzangen – Bone Holding Forceps, Bone Rongeurs

Sehnenstripper Tendon Strippers

FO

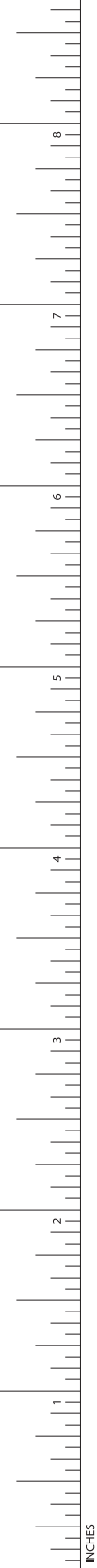

Ø
diam.

FO923R 3 mm

Sehnenstripper
Schaftlänge: 190 mm
Tendon stripper
Shaft length: 7 1/2"
300 mm, 11 1/2"



Ø
diam.

FO925R 5 mm

Sehnenstripper
Schaftlänge: 390 mm
Tendon stripper
Shaft length: 15 1/3"
495 mm, 19 1/2"

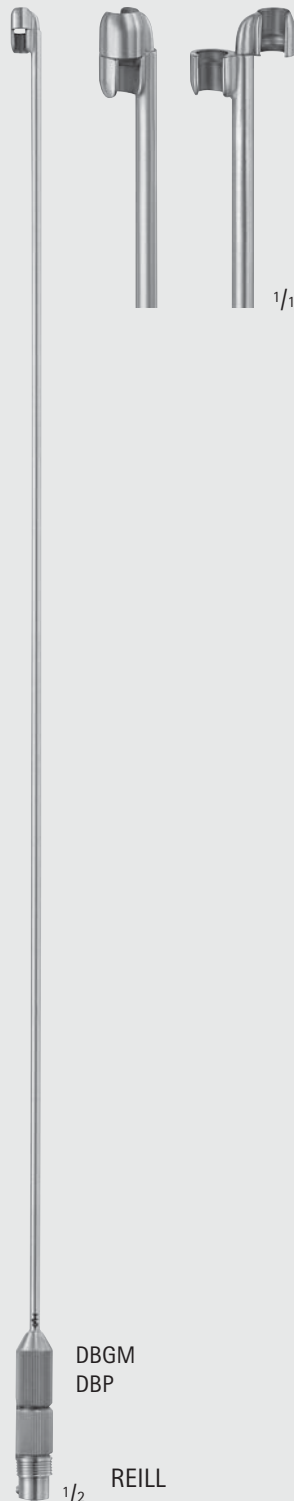

DBGM
DBP

REILL

Ø
diam.

FO928R 4 mm

FO930R 6 mm

Sehnenstripper
Schaftlänge: 350 mm
Tendon stripper
Shaft length: 13 3/4"
395 mm, 15 1/2"

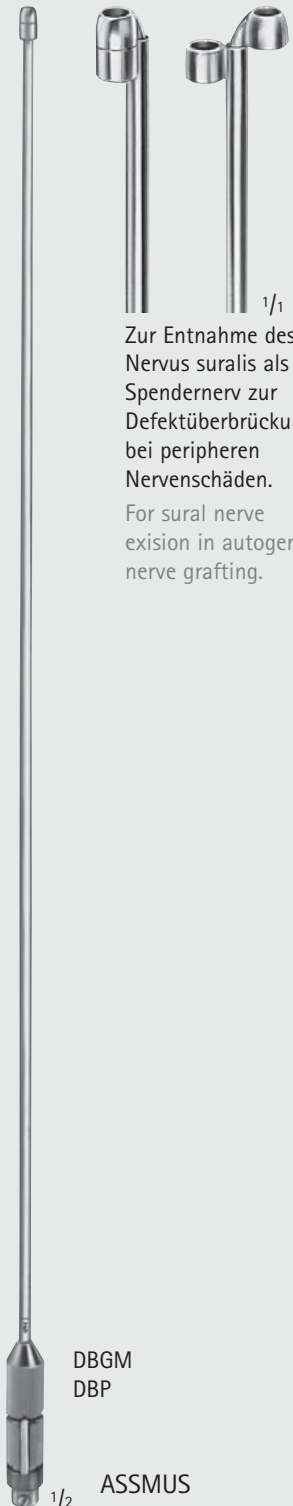

DBGM
DBP

ASSMUS

Ø
diam.

FD610R 3 mm

Nervenstripper, stumpf
Schaftlänge: 350 mm
Nerve stripper, blunt
Shaft length: 13 3/4"
395 mm, 15 1/2"

Zur Entnahme des Nervus suralis als Spendernerv zur Defektüberbrückung bei peripheren Nervenschäden.
For sural nerve excision in autogenous nerve grafting.



Knochenhaltezangen, Hohlmeißelzangen – Bone Holding Forceps, Bone Rongeurs

Sehnenstripper Tendon Strippers

FO

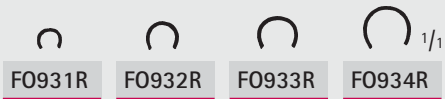

FO931R FO932R FO933R FO934R ^{1/1}



BRUNNELL

Ø
diam.

| | |
|--------|------|
| FO931R | 2 mm |
| FO932R | 3 mm |
| FO933R | 4 mm |
| FO934R | 6 mm |

135 mm, 5 1/4"



FO935R

FO937R ^{1/1}

1/2

Ø
diam.

| | |
|--------|------|
| FO935R | 3 mm |
| FO937R | 5 mm |

300 mm, 12"

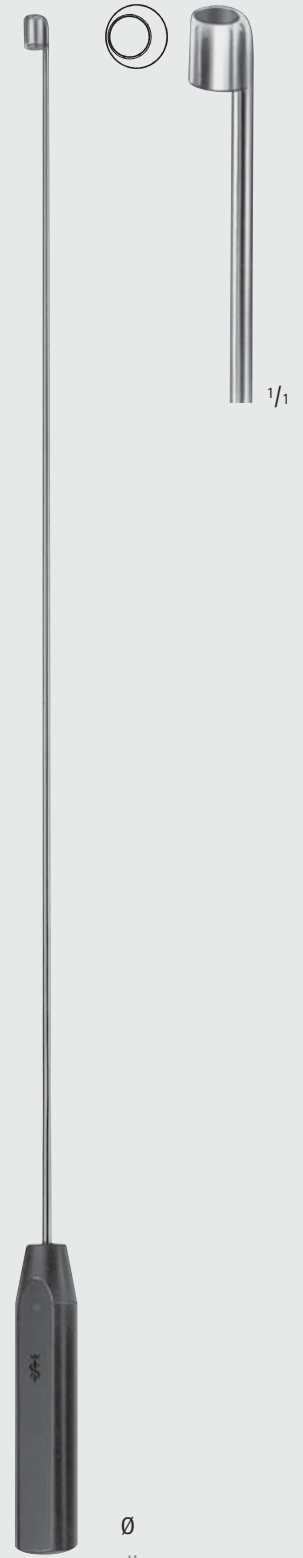

FO939R 5 mm

500 mm, 19 1/2"

1/1

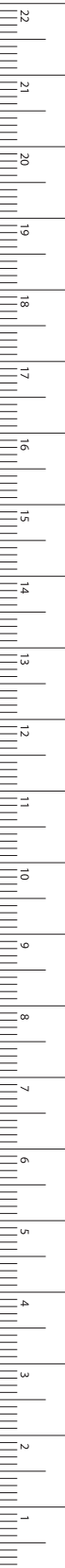

MILLIMETERS

Knochenhaltezangen, Hohlmeißelzangen – Bone Holding Forceps, Bone Rongeurs
 Sehnedurchziehsonden
 Tendon Passing Probes

FO



1/2

BUNNELL

FO940R

230 mm, 9"



1/2

Knopf-Ø
diam. of tip

BN034R 2,5 mm

145 mm, 5 3/4"



1/2

Knopf-Ø
diam. of tip

BN036R 2,5 mm

160 mm, 6 1/4"



1/2

Knopf-Ø
diam. of tip

BN040R 3,0 mm

200 mm, 8"

INCHES

Knochenhaltezangen, Hohlmeißelzangen – Bone Holding Forceps, Bone Rongeurs

Bleihände, Handfixierplatte

Lead Hands, Hand Fixation Plate

FO

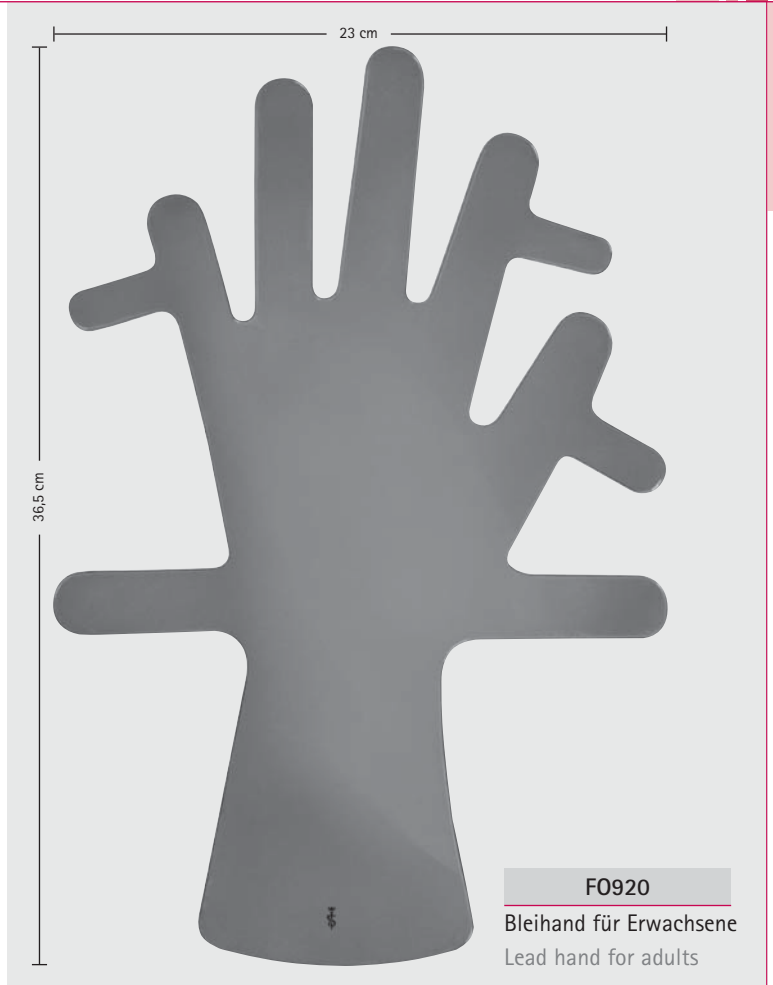
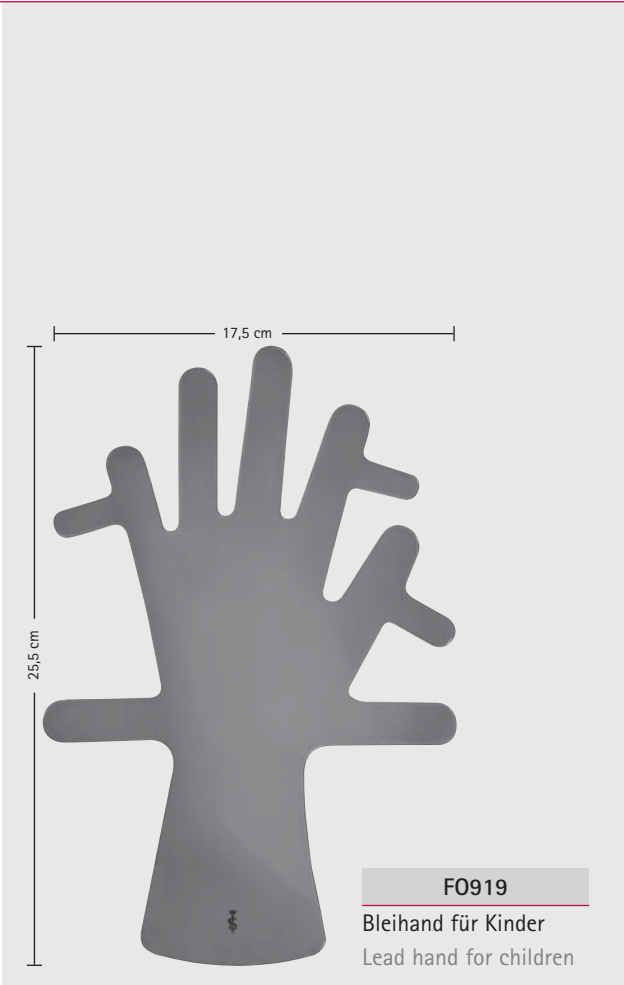

Plastic Surgery

Aluminum Hand

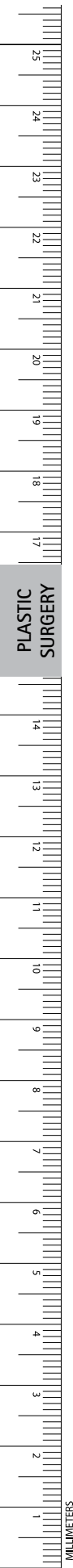

27.5 cm

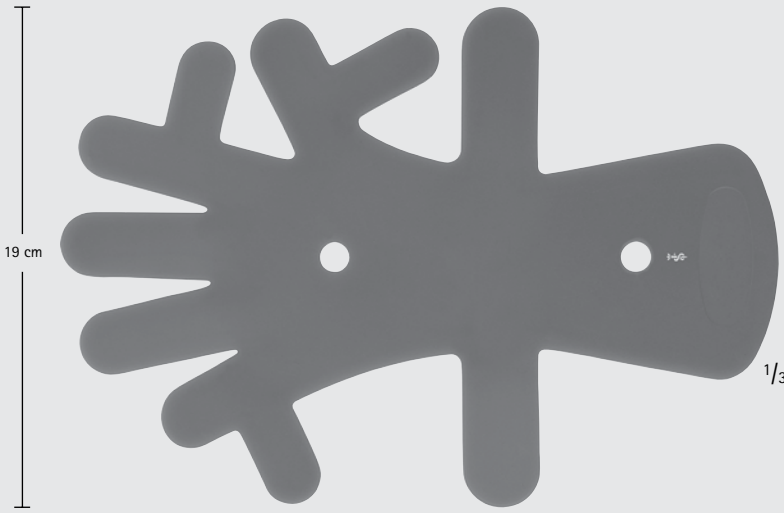

F0917A

Aluminum Hand, Blue Silicone Coated

| Catalog Number | Size (in.) |
|----------------|----------------|
| F0917A | 10 3/4 x 7 1/2 |
| F0918A | 16 1/8 x 11 |

41 cm

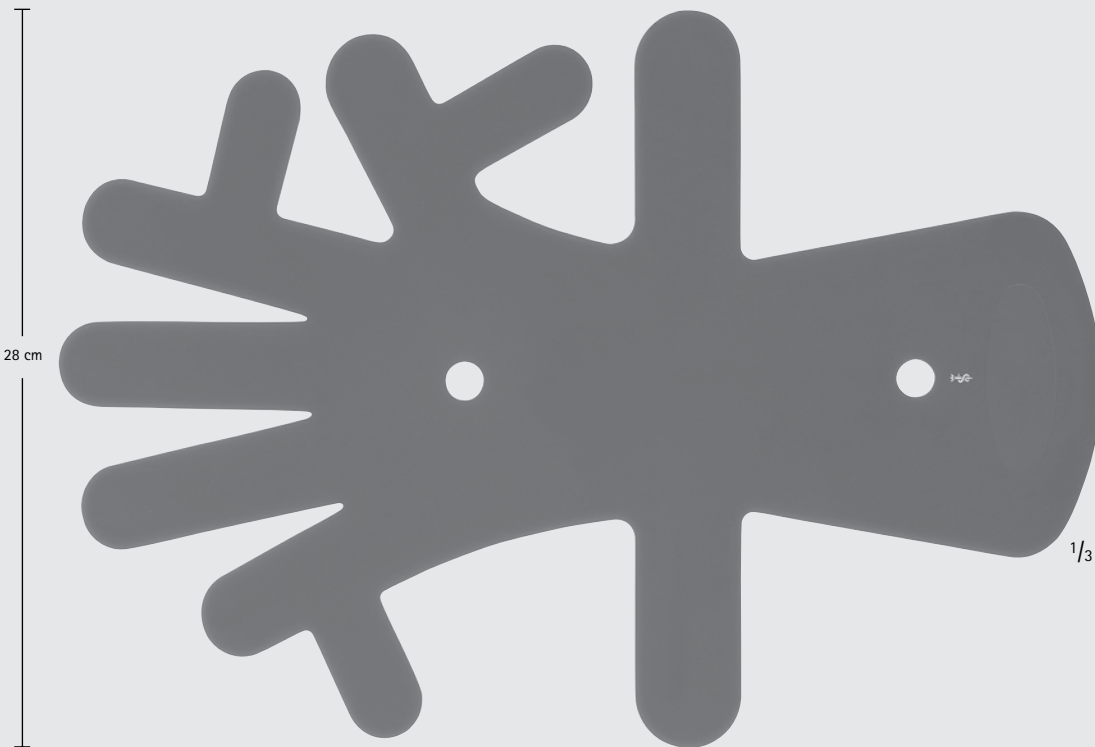

F0918A

По вопросам продаж и поддержки обращайтесь:

| | | | |
|-----------------------------|---------------------------------|--------------------------------|---------------------------|
| Алматы (7273)495-231 | Казань (843)206-01-48 | Новокузнецк (3843)20-46-81 | Смоленск (4812)29-41-54 |
| Архангельск (8182)63-90-72 | Калининград (4012)72-03-81 | Новосибирск (383)227-86-73 | Сочи (862)225-72-31 |
| Астрахань (8512)99-46-04 | Калуга (4842)92-23-67 | Омск (3812)21-46-40 | Ставрополь (8652)20-65-13 |
| Барнаул (3852)73-04-60 | Кемерово (3842)65-04-62 | Орел (4862)44-53-42 | Сургут (3462)77-98-35 |
| Белгород (4722)40-23-64 | Киров (8332)68-02-04 | Оренбург (3532)37-68-04 | Тверь (4822)63-31-35 |
| Брянск (4832)59-03-52 | Краснодар (861)203-40-90 | Пенза (8412)22-31-16 | Томск (3822)98-41-53 |
| Владивосток (423)249-28-31 | Красноярск (391)204-63-61 | Пермь (342)205-81-47 | Тула (4872)74-02-29 |
| Волгоград (844)278-03-48 | Курск (4712)77-13-04 | Ростов-на-Дону (863)308-18-15 | Тюмень (3452)66-21-18 |
| Вологда (8172)26-41-59 | Липецк (4742)52-20-81 | Рязань (4912)46-61-64 | Ульяновск (8422)24-23-59 |
| Воронеж (473)204-51-73 | Магнитогорск (3519)55-03-13 | Самара (846)206-03-16 | Уфа (347)229-48-12 |
| Екатеринбург (343)384-55-89 | Москва (495)268-04-70 | Санкт-Петербург (812)309-46-40 | Хабаровск (4212)92-98-04 |
| Иваново (4932)77-34-06 | Мурманск (8152)59-64-93 | Саратов (845)249-38-78 | Челябинск (351)202-03-61 |
| Ижевск (3412)26-03-58 | Набережные Челны (8552)20-53-41 | Севастополь (8692)22-31-93 | Череповец (8202)49-02-64 |
| Иркутск (395)279-98-46 | Нижний Новгород (831)429-08-12 | Симферополь (3652)67-13-56 | Ярославль (4852)69-52-93 |
| Россия (495)268-04-70 | Киргизия (996)312-96-26-47 | Казахстан (7172)727-132 | |