

Технические характеристики

По вопросам продаж и поддержки обращайтесь:

Алматы (7273)495-231	Казань (843)206-01-48	Новокузнецк (3843)20-46-81	Смоленск (4812)29-41-54
Архангельск (8182)63-90-72	Калининград (4012)72-03-81	Новосибирск (383)227-86-73	Сочи (862)225-72-31
Астрахань (8512)99-46-04	Калуга (4842)92-23-67	Омск (3812)21-46-40	Ставрополь (8652)20-65-13
Барнаул (3852)73-04-60	Кемерово (3842)65-04-62	Орел (4862)44-53-42	Сургут (3462)77-98-35
Белгород (4722)40-23-64	Киров (8332)68-02-04	Оренбург (3532)37-68-04	Тверь (4822)63-31-35
Брянск (4832)59-03-52	Краснодар (861)203-40-90	Пенза (8412)22-31-16	Томск (3822)98-41-53
Владивосток (423)249-28-31	Красноярск (391)204-63-61	Пермь (342)205-81-47	Тула (4872)74-02-29
Волгоград (844)278-03-48	Курск (4712)77-13-04	Ростов-на-Дону (863)308-18-15	Тюмень (3452)66-21-18
Вологда (8172)26-41-59	Липецк (4742)52-20-81	Рязань (4912)46-61-64	Ульяновск (8422)24-23-59
Воронеж (473)204-51-73	Магнитогорск (3519)55-03-13	Самара (846)206-03-16	Уфа (347)229-48-12
Екатеринбург (343)384-55-89	Москва (495)268-04-70	Санкт-Петербург (812)309-46-40	Хабаровск (4212)92-98-04
Иваново (4932)77-34-06	Мурманск (8152)59-64-93	Саратов (845)249-38-78	Челябинск (351)202-03-61
Ижевск (3412)26-03-58	Набережные Челны (8552)20-53-41	Севастополь (8692)22-31-93	Череповец (8202)49-02-64
Иркутск (395)279-98-46	Нижний Новгород (831)429-08-12	Симферополь (3652)67-13-56	Ярославль (4852)69-52-93
Россия (495)268-04-70	Киргизия (996)312-96-26-47	Казахстан (7172)727-132	



Elektrochirurgie – Electro Surgery

Koagulations-Absaugkanülen Coagulation Suction Cannula

GK

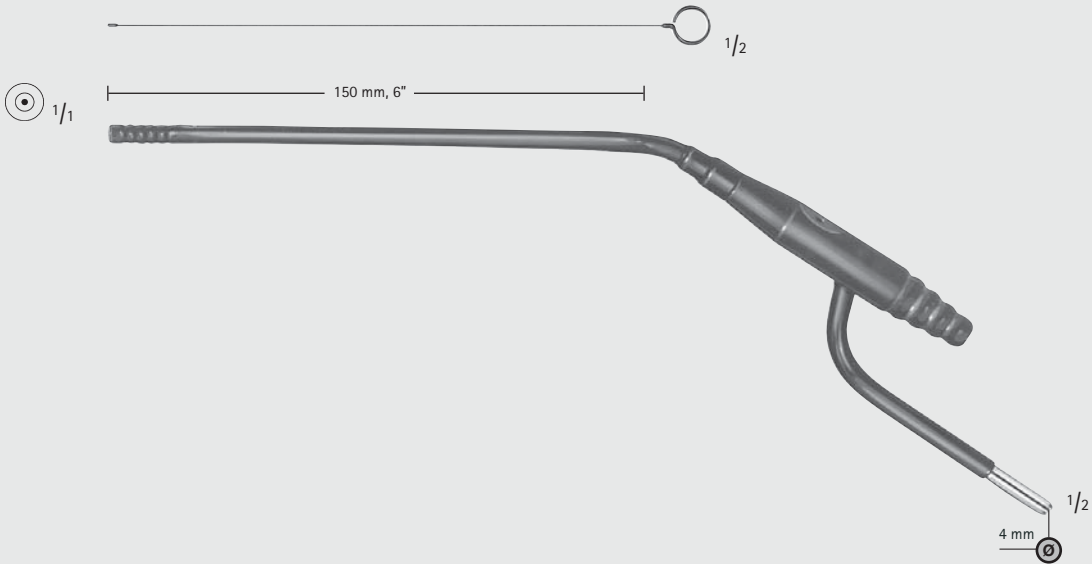

LANDOLT

GK550

Koagulations-Absaugkanüle mit Mandrin
Coagulation suction cannula with mandrel

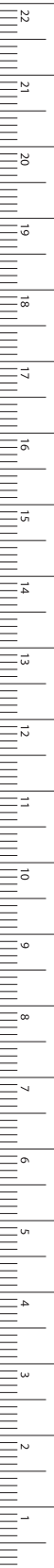

MILLIMETERS

ENT-EAR

Suction Irrigation

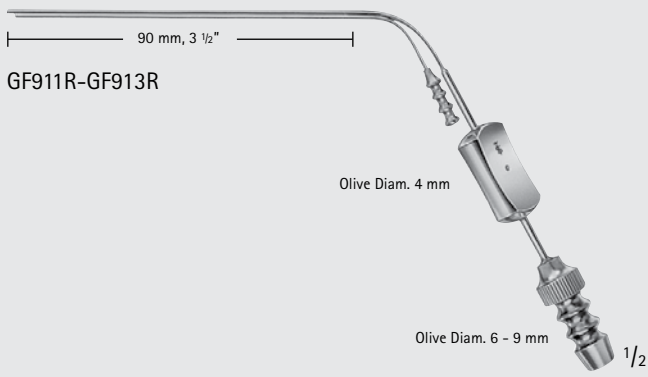

HOUSE Suction Irrigation Cannula

Catalog Number	Tip Size (mm)	Working Length (in.)
GF911R	0.9 / 0.7	3 1/2
GF912R	1.2 / 0.9	3 1/2
GF913R	1.5 / 1.2	3 1/2

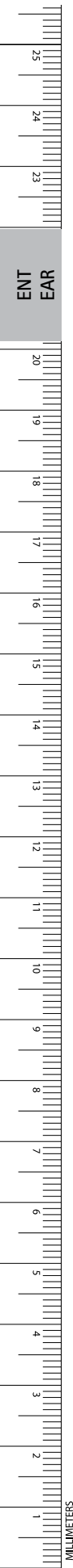

Biopsie- und Kürettage-Instrumente – Biopsy Instruments and Curettes

Uterus-Kanülen

Uterine Cannulae

ER



ER871R

klein

small

Ø 10 x 25 mm

diam. 10 x 25 mm



ER872R

mittel

medium

Ø 13 x 30 mm

diam. 13 x 30 mm



ER873R

groß

large

Ø 16 x 30 mm

diam. 16 x 30 mm

¹/₂

LEECH-WILKINSON

ER871R-ER873R

265 mm, 10 ¹/₂"



¹/₂

SPACKMAN

ER874R

mit Befestigungsplatte für
Hakenzange verstellbar

with adjustable plate for
vulsellum forceps

360 mm, 14 ¹/₄"

Biopsie- und Kürettage-Instrumente – Biopsy Instruments and Curettes

Uterus-Kanülen, Spülkatheter

Uterine Cannulae, Irrigation Catheter

ER

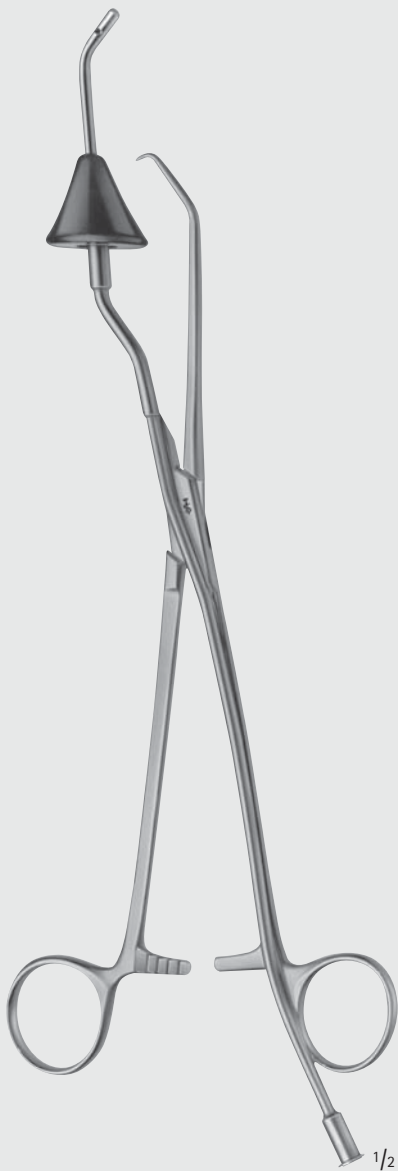

BEHRMAN

ER875

Uterus-Kanüle
mit abnehmbarem Konus
Uterine cannula
with detachable cone
305 mm, 12"



ER876

Uterus-Kanüle
mit Federmechanismus, selbsthaltend,
komplett mit 2 auswechselbaren Koni
groß und klein
Uterine cannula
with spring connector, self-retaining,
complete with 2 interchangeable cones
large and small
250 mm, 13"



ROTUNDA

ER867R

Spülkatheter
Ø 5 mm
Irrigation cannula
diam. 5 mm
200 mm, 8"



MILLIMETERS



Nach Applikation der Führungshülse am Injektionsort wird die Kanüle (mit aufgesetzter Spritze) durch den Trichter bzw. durch die Hülse hindurchgeführt und ins Gewebe eingestochen. Verletzungen der Vagina werden dabei vermieden. Die Einstichtiefe ist auf ca. 10 mm begrenzt. Ein Daumenring sowie eine kleine Stütze für Zeige- oder Mittelfinger dienen zur besseren Handhabung. Der Daumenring ist auf der Führungshülse verschiebbar und kann mit einer Rändelmutter – für jede Hand passend – fixiert werden. Die Fingerstütze läßt sich um die Führungshülse drehen und ermöglicht dadurch die Verwendung sowohl für Rechts- als auch für Linkshänder. Außerdem kann die Fingerstütze – evtl. bei der Pudendusnästhesie – ganz aus dem Aktionsbereich heraus in Richtung Daumenring geschoben werden.

When the guide sheath is introduced at the spot to be injected the needle (mounted on the syringe) is passed through the guide sheath and the tissue is finally injected. Injuries of the vagina are thus avoided. Depth of puncture is limited to 10 mm. Thumb ring as well as a small support for middle- or forefinger facilitate the handling. Thumb ring slides on the guide sheath and can be fixed by a knurled nut to any size of the hand. The finger support can be turned round on the guide sheath so left-handers can use it, too. Completely away from the range of actions is the finger support when it is moved towards the thumb ring, e.g. for anesthesia of the pudendus.

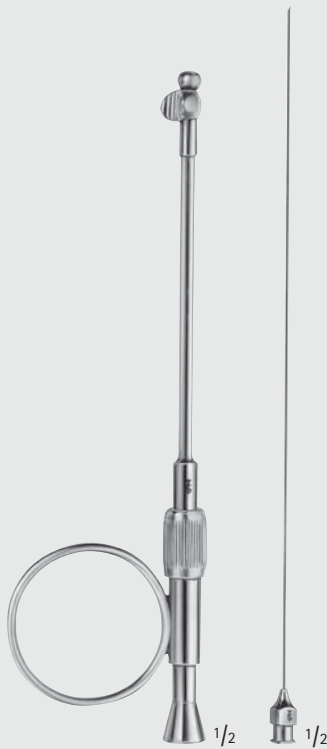

ET096R

Führungshülse
Guide sheath
175 mm, 7"

SR580R

Injektionskanüle Luer-Lock
Injection needle Luer-Lock hub
1,0 x 185 mm

Spezialbesteck zur transvaginalen
Injektion bei Paracervical-und
Pudendusnästhesie

Special set for transvaginal injection
for paracervical anesthesia as well
as anesthesia of the pudendus



Herz- und Gefäß-Chirurgie – Cardiovascular Surgery

Spülkanülen, Embolusfazzangen

Irrigating Cannulae, Embolus Grasping Forceps

FB



Ø 3 mm
diam. 3 mm



FB153R

Ø 4 mm
diam. 4 mm



FB154R

Ø 5 mm
diam. 5 mm

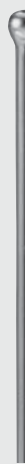

FB155R

Ø 6 mm
diam. 6 mm



FB156R

LUER
LOCK

1/2

SCHMID

FB153R-FB156R

Gefäß-Spülkanülen,
biegsam, versilbert

Vessel irrigating cannulae,
malleable, silver plated

150 mm, 6"

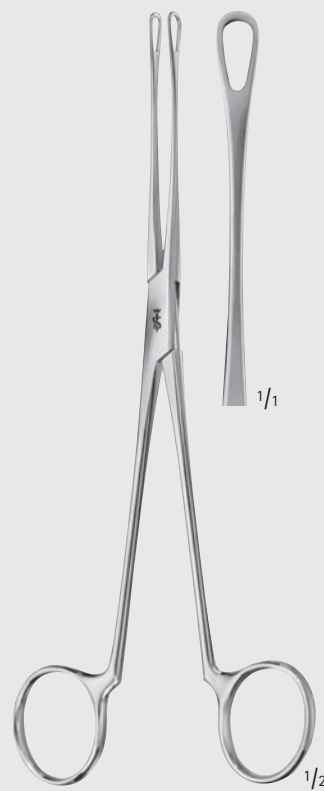

BLAKE

EB220R

Embolusfazzange

Embolus grasping forceps

205 mm, 8"



Sauginstrumente – Suction Instruments

Sauginstrumente
Suction Instruments

GF



Ø 9 mm
diam. 9 mm

GF816C

Universal-Kanüle, doppelt gebogen
Universal cannula, double curved
230 mm, 9"

Olive Ø 9 mm
olive diam. 9 mm



▲
Ø 7 mm
Charr. 21

POOL

GF860R

Saugkanüle mit abschraubbarem Außenrohr
Suction cannula, with outer tube to be screwed off
225 mm, 9"

1/2
Olive Ø 6,5 - 9,5 mm
olive diam. 6.5 - 9.5 mm



▲
Ø 10 mm
Charr. 30

POOL

GF862R

Saugkanüle mit abschraubbarem Außenrohr
Suction cannula with outer tube to be screwed off
225 mm, 9"

1/2
Olive Ø 8 - 10,5 mm
olive diam. 8 - 10.5 mm



Ø 10 mm
diam. 10 mm

YANKAUER

GF944R

mit zentraler Bohrung, Ø 2,0 mm
with central bore, 2.0 mm diam.
285 mm, 11 1/4"

1/2
Olive Ø 7 - 9 mm
olive diam. 7 - 9 mm



MILLIMETERS

Sauginstrumente – Suction Instruments

Sauginstrumente

Suction Instruments

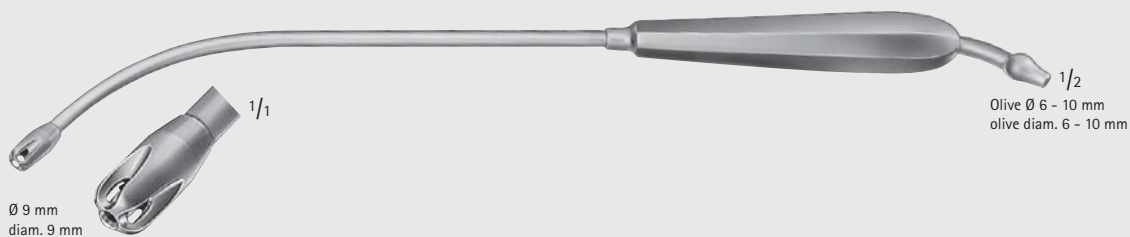

DE BAKEY

GF946R

mit zentraler Bohrung, Ø 3,0 mm und seitlichen Schlitzen

with central bore, 3.0 mm diam. with lateral slots

275 mm, 10 3/4"

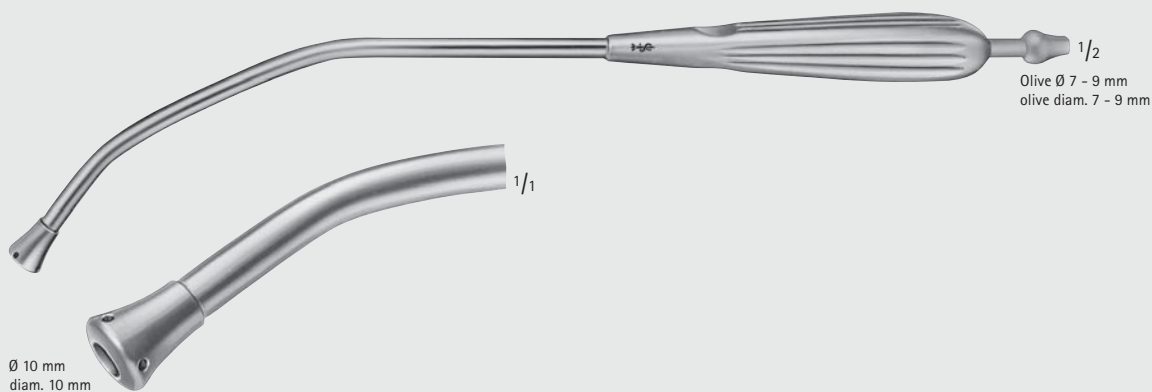

YANKAUER

OM671R

mit besonders großer zentraler Bohrung, Ø 4,8 mm

with especially large central bore, 4.8 mm diam.

285 mm, 11 1/4"

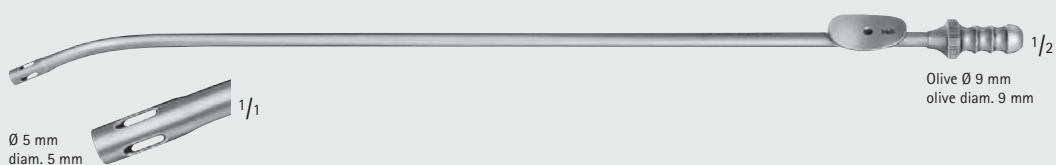

DE BAKEY

GF948R

mit Saugunterbrecher und Mandrin

with finger cut-off and stylet

270 mm, 10 3/4"

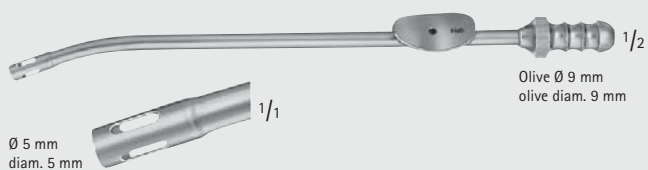

DE BAKEY

GF947R

mit Saugunterbrecher und Mandrin

with finger cut-off and stylet

160 mm, 6 1/4"



Sauginstrumente – Suction Instruments

Sauginstrumente

Suction Instruments

GF

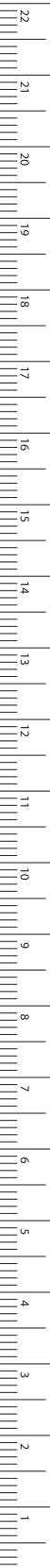

MILLIMETERS

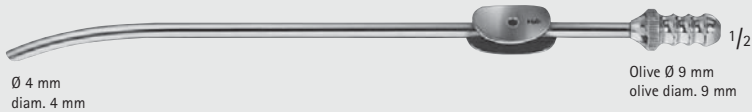

Ø 4 mm
diam. 4 mm

Olive Ø 9 mm
olive diam. 9 mm

ADSON

GF917R

mit Saugunterbrecher
with finger cut-off
190 mm, 7 1/2"

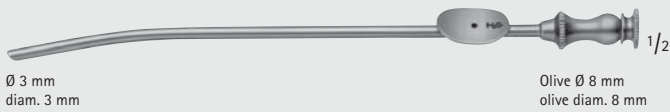

Ø 3 mm
diam. 3 mm

Olive Ø 8 mm
olive diam. 8 mm

ADSON

GF918R

mit Saugunterbrecher und Mandrin
with finger cut-off and stylet
165 mm, 6 1/2"

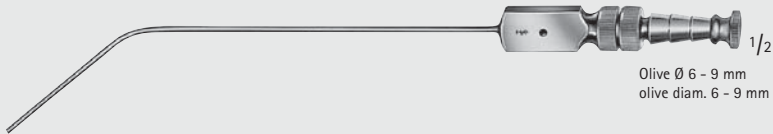

Olive Ø 6 - 9 mm
olive diam. 6 - 9 mm

PLESTER

mit Saugunterbrecher und Mandrin,
Griffplatte parallel zur Biegung, LUER-Bohrung
with finger cut-off and stylet, thumb piece
parallel to curve, with LUER hub
195 mm, 7 3/4"

	Ø diam.
GF939R	1,5 mm
GF940R	2,0 mm
GF941R	2,5 mm
GF942R	3,0 mm
GF355R	5,0 mm

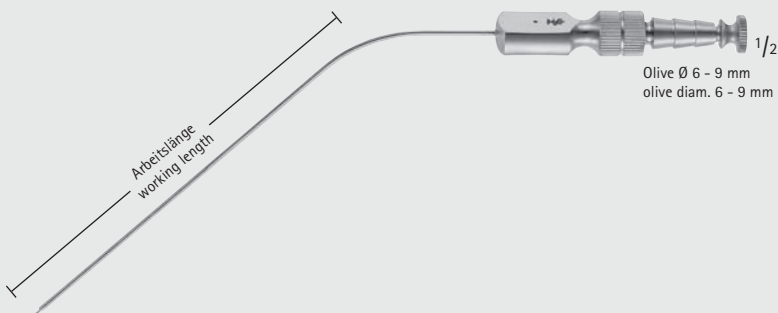

Olive Ø 6 - 9 mm
olive diam. 6 - 9 mm

FERGUSSON

mit Saugunterbrecher und Mandrin,
Griffplatte 90° zur Biegung, LUER-Bohrung
with finger cut-off and stylet, thumb piece
90° to curve, with LUER hub
180 mm, 7"

	diam. Ø
GF350R	1,5 mm
GF351R	2,0 mm
GF352R	2,5 mm
GF353R	3,0 mm
GF354R	4,0 mm

Sauginstrumente – Suction Instruments

Sauginstrumente

Suction Instruments



Olive Ø 6 - 9 mm
olive diam. 6 - 9 mm

FERGUSSON

GF933R Ø diam. 4,0 mm

isoliert, mit Saugunterbrecher und Mandrin,
Griffplatte 90° zur Biegung, LUER-Bohrung

isolated, with finger cut-off and stylet,
thumb piece 90° to curve, with LUER hub

180 mm, 7"



Olive Ø 6 - 9 mm
olive diam. 6 - 9 mm

FRAZIER

Ø	diam.
---	-------

GF923R	3,0 mm
---------------	--------

GF925R	5,0 mm
---------------	--------

mit Saugunterbrecher und Mandrin,
Griffplatte 90° zur Biegung, LUER-Bohrung

with finger cut-off and stylet, thumb
piece 90° to curve, with LUER hub

180 mm, 7"



FRAZIER

Ø	diam.
---	-------

MD124R	2,3 mm
---------------	--------

MD125R	2,7 mm
---------------	--------

MD127R	3,4 mm
---------------	--------

MD129R	4,0 mm
---------------	--------

mit Saugunterbrecher und Mandrin,
Griffplatte 90° zur Biegung, LUER-Bohrung
with finger cut-off and stylet, thumb piece 90°
to curve, with LUER hub

110 mm, 4 1/4"



Sauginstrumente – Suction Instruments

Sauginstrumente Suction Instruments

GF



LEMPERT

Ø
diam.

GF937R 2,0 mm

GF938R 3,0 mm

mit Saugunterbrecher und Mandrin
with finger cut-off and stylet
200 mm, 8"

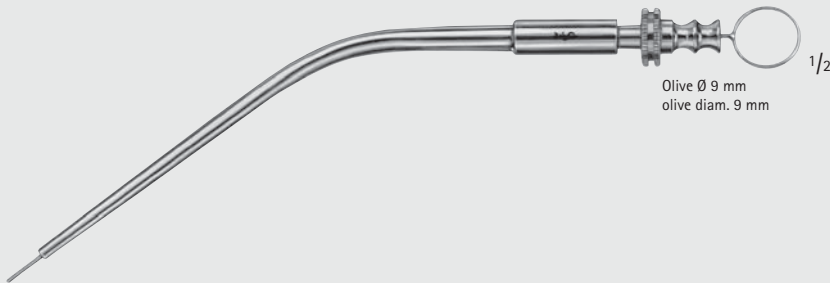

FORMBY

Ø
diam.

GF932R 3,3 mm

210 mm, 8 1/4"



BARRON

Ø
diam.

GF935R 1,3 mm

GF936R 2,0 mm

mit Saugunterbrecher und Mandrin
with finger cut-off and stylet
160 mm, 6 1/4"



SCHUHKNECHT

Ø Ø
diam. diam.

GF756R 20 swg 1,0 mm

GF757R 24 swg 0,5 mm

Saugkanülen
Suction cannulae
130 mm, 5 1/8"



MILLIMETERS

Sauginstrumente – Suction Instruments

Sauginstrumente

Suction Instruments

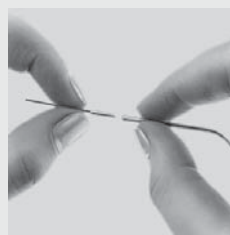

WULLSTEIN

OG960R

Mikro-Absaugrohr komplett, bestehend aus:

Micro suction tube, complete, consisting of:

OG961R	Absaugrohr mit LUER-Bohrung	Suction tube with LUER hub
OG962R	Mikro-Saugkanüle, Ø 0,4 mm	Micro suction cannula, 0.4 mm diam.
OG963R	Mikro-Saugkanüle, Ø 0,6 mm	Micro suction cannula, 0.6 mm diam.
OG964R	Mikro-Saugkanüle, Ø 0,8 mm	Micro suction cannula, 0.8 mm diam.

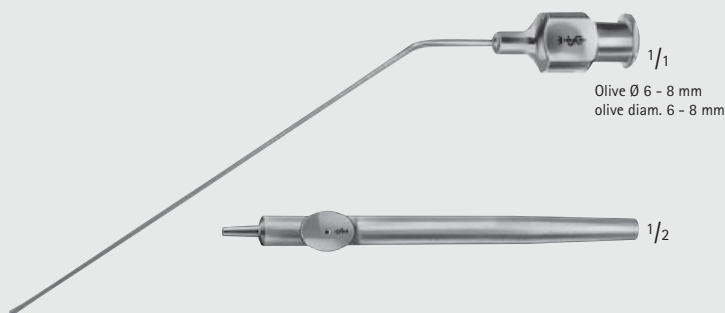

OG970R

Saugset komplett, bestehend aus:

Suction set, complete, consisting of:

OG971R	Saughandgriff mit LUER-Konus, mit Unterbrecher	Suction handle, with finger cut-off, with LUER cone
OG972R	2 Saugkanülen, Ø 0,5 mm, mit LUER-Konus	2 suction cannulae, 0.5 mm diam., with LUER cone
OG973R	2 Saugkanülen, Ø 0,7 mm, mit LUER-Konus	2 suction cannulae, 0.7 mm diam., with LUER cone
OG974R	2 Saugkanülen, Ø 1,0 mm, mit LUER-Konus	2 suction cannulae, 1.0 mm diam., with LUER cone
OG969R	2 Saugkanülen, Ø 1,3 mm, mit LUER-Konus	2 suction cannulae, 1.3 mm diam., with LUER cone

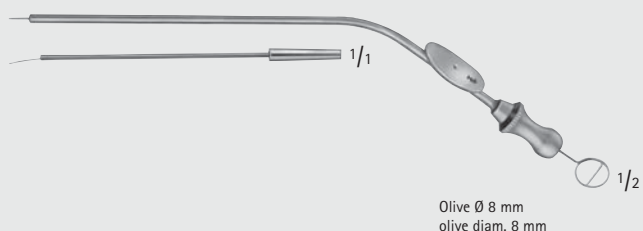

BELLUCCI

OG950R

Saugset komplett, bestehend aus:

Suction set, complete, consisting of:

OG951R	Saugrohr allein, mit Saugunterbrecher und Mandrin	Suction tube with finger cut-off and stylet	155 mm, 6"
GF772R	Saugkanüle Ø 20 swg., Ø 1,0 mm	Detachable end, 20 swg. diam., 1.0 mm diam.	
GF773R	Saugkanüle Ø 22 swg., Ø 0,7 mm	Detachable end, 22 swg. diam., 0.7 mm diam.	
GF774R	Saugkanüle Ø 24 swg., Ø 0,5 mm	Detachable end, 24 swg. diam., 0.5 mm diam.	



Sauginstrumente – Suction Instruments

Sauginstrumente Suction Instruments

GF



ZOELLNER

GF770R

Saugkanüle allein, mit Mandrin, passend zu den Saugaufsätzen GF771R und GF775R

Suction cannula only, with stylet, fitting to the detachable ends GF771R and GF775R

180 mm, 7"



ZOELLNER

	Ø diam.	Ø diam.
GF771R	18 swg	1,2 mm
GF772R	20 swg	1,0 mm
GF773R	22 swg	0,7 mm
GF774R	24 swg	0,5 mm
GF775R	26 swg	0,4 mm

auswechselbare Spitzen zu GF770R und OG951R
detachable ends, fitting to GF770R and OG951R

Bestelleinheit:

PAK = Packung à 10 Stück

Sales unit:

PAK = Package of 10 pieces



VERHOEVEN

	Ø diam.	Ø diam.
GF763R	16 swg	1,5 mm
GF764R	18 swg	1,2 mm
GF765R	20 swg	1,0 mm
GF766R	22 swg	0,7 mm
GF767R	24 swg	0,5 mm

Saugkanülen mit LUER-Konus

Suction cannulae with LUER cone

100 mm, 4"



Olive Ø 7 mm
olive diam. 7 mm

HOUSE

GF768R

Saugadapter mit Saugunterbrecher,
LUER-Konus / LUER-Bohrung

Suction adapter with finger cut-off,
LUER cone, LUER hub

55 mm, 2 1/8"



Ø 1,75 mm
diam. 1.75 mm

Ø 3 mm
diam. 3 mm

Olive Ø 8 mm
olive diam. 8 mm

WULLSTEIN

OF237

Saugrohr, konisch, aus Silber, Olive mit LUER-Bohrung

Suction tube, conical, silver, olive with LUER hub

160 mm, 6 1/4"



MILLIMETERS

General Surgery

Suction Tubes



Diam. 4 mm

Olive Diam. 9 mm

1/2

GF917R

ADSON Suction Tube

Catalog Number	Tip Size (mm)	Tip Size (FR)	Length (in.)
GF917R	4	11	7 1/2

Olive Diam. 6 - 9 mm

1/2

GF919R

Nasal Suction Tube W/ Luer Hub, Tapered

Catalog Number	Tip Size (mm)	Length (in.)
GF919R	5	7

Diam. 8 mm Outer Tube

Olive Diam. 9 - 11 mm

1/2

GF821R

COOLEY Suction Tube

Catalog Number	Tip Size (mm)	Length (in.)
GF821R	8.0	13 1/4

General Surgery

Suction Tubes

GENERAL SURGERY

COOLEY Suction Tube W/ Detachable Tip

Catalog Number	Tip Size (mm)	Shaft	Length (in.)
GF822R	8.0	SLT-CVD	12 1/4
GF823R	9.0	CVD	11 5/8
GF824R	8.0	ANG	12 1/2
GF825R	9.0	90°	10 1/2



GF822R

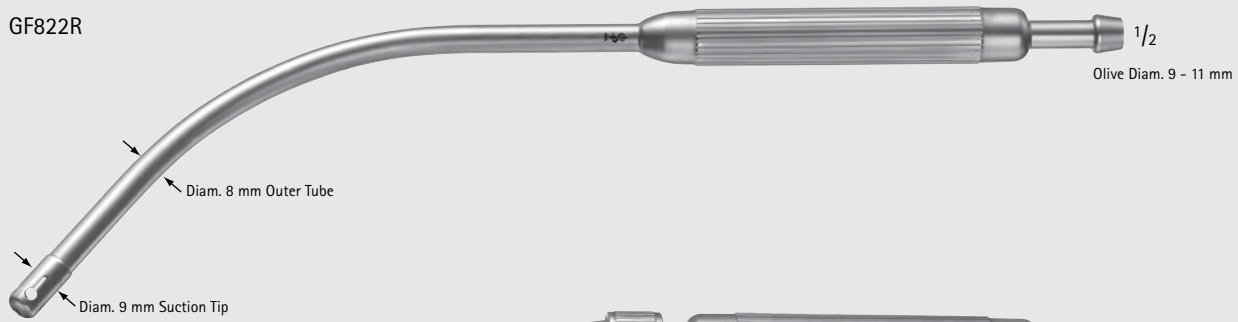

GF823R



GF824R

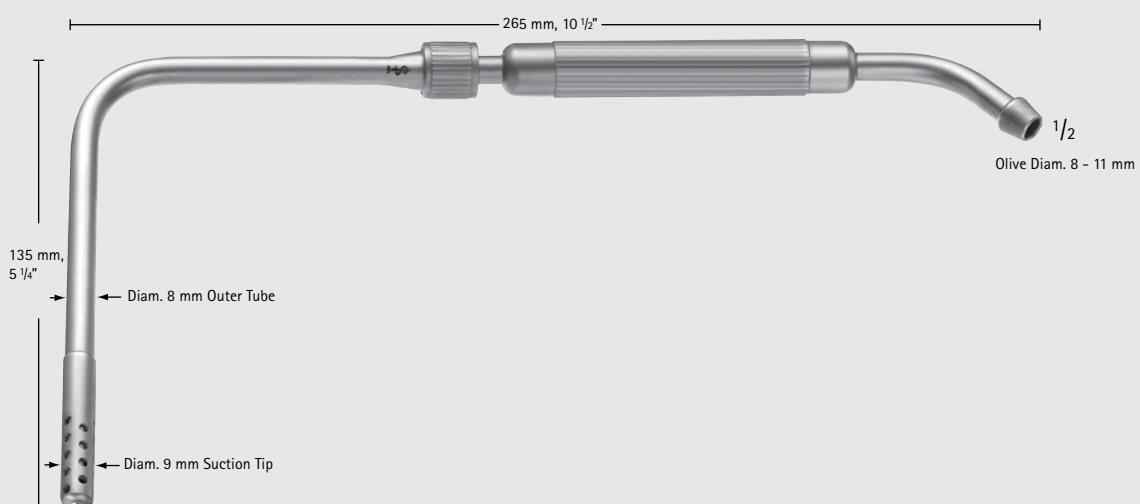

GF825R



INCHES

General Surgery

Suction Tubes



Grafting Suction Tube

Catalog Number	Tip Size (mm)	Length (in.)
MB286R	3	9 1/2
MB287R	4	9 1/2



MB286R-MB287R

DEBAKEY Suction Tube

Catalog Number	Tip Size (mm)	Length (in.)
GF946R	3	10 3/4
GF947R	5	6 1/4
GF948R	5	10 5/8
GF946205	REPLACEMENT TIP FOR GF946R	-



GF946R



Diam. 9 mm

GF946R



GF947R

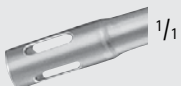

Diam. 5 mm

GF947R

Olive Diam. 9 mm

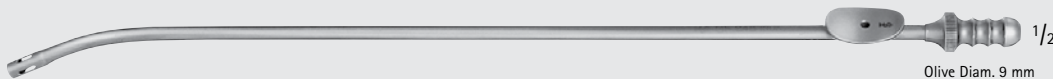

GF948R



Diam. 5 mm

GF948R

Olive Diam. 9 mm

Instruments - Instrumente

Suction Cannulas

Saugkanülen

Suction
Sauger



CERULLO

GF966R

Suction regulating valve
for fine adjustment of the suction efficiency
Saugreguliertventil
zur freien Feineinstellung der Saugleistung

Cardiovascular
Specialty CV/Thoracic Instruments



MD610-MD611

Heparin Needle

Catalog Number	Gauge	Length (in.)
MD610	13	3 1/2
MD611	18	3 3/4



**OF254C**

HARTMANN Eustachian Catheter, diam. 5 mm

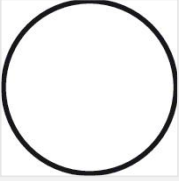

Product search type	Eustachian Catheter
Author	HARTMANN
Aesculap Product	
Groups	General Surgical Instruments
Diameter (mm)	5,00 mm
Surgical Step	Surgical Access
Indication	Otology
Data Matrix	No
Product contains	
Latex	No
Sterility	non-sterile
Disposable /	
Reusable	reusable

**OF250C**

HARTMANN Eustachian Catheter, diam. 2 mm



Product search type	Eustachian Catheter
Author	HARTMANN
Aesculap Product	
Groups	General Surgical Instruments
Diameter (mm)	2,00 mm
Surgical Step	Surgical Access
Indication	Otology
Data Matrix	No
Product contains	
Latex	No
Sterility	non-sterile
Disposable /	
Reusable	reusable

**OF251C**

HARTMANN Eustachian Catheter, diam. 2,50 mm



Product search type	Eustachian Catheter
Author	HARTMANN
Aesculap Product	
Groups	General Surgical Instruments
Diameter (mm)	2.50 mm
Surgical Step	Surgical Access
Indication	Otology
Data Matrix	No
Product contains	
Latex	No
Sterility	non-sterile
Disposable /	
Reusable	reusable

**OF252C**

HARTMANN Eustachian Catheter, diam. 3 mm

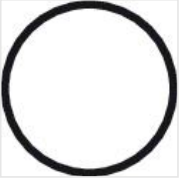

Product search type	Eustachian Catheter
Author	HARTMANN
Aesculap Product	
Groups	General Surgical Instruments
Diameter (mm)	3.00 mm
Surgical Step	Surgical Access
Indication	Otology
Data Matrix	No
Product contains	
Latex	No
Sterility	non-sterile
Disposable /	
Reusable	reusable

**OF253C**

HARTMANN Eustachian Catheter, diam. 4 mm

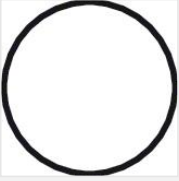

Product search type	Eustachian Catheter
Author	HARTMANN
Aesculap Product	
Groups	General Surgical Instruments
Diameter (mm)	4.00 mm
Surgical Step	Surgical Access
Indication	Otology
Data Matrix	No
Product contains	
Latex	No
Sterility	non-sterile
Disposable /	
Reusable	reusable

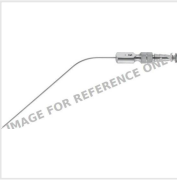

OG984R

PLESTER Suction Cannula, knee-bent, working length: 55 mm (2 1/4"), diam. 2,50 mm, luer lock, non-sterile, reusable

Product search type	Suction Cannula
Author	PLESTER
Aesculap Product	
Groups	General Surgical Instruments
Geometry	knee-bent
Working length (mm)	55.0 mm
Working length (Inch)	2 1/4
Diameter (mm)	2.50 mm
Attachment	luer lock
Discipline	Ear-Nose-Throat Surgery, Hand / Foot Surgery, Maxillo-Facial Surgery, Pediatric Surgery
Data Matrix	No
Disposable / Reusable	reusable
Sterility	non-sterile
Product contains Latex	No



OG982R

PLESTER Suction Cannula, knee-bent, diam. 1,50 mm, luer attachment, non-sterile, reusable

Product search type	Suction Cannula
Author	PLESTER
Aesculap Product	
Groups	ENT, General Surgical Instruments
Geometry	knee-bent
Diameter (mm)	1.50 mm
Attachment	luer attachment
Discipline	Ear-Nose-Throat Surgery, Hand / Foot Surgery, Maxillo-Facial Surgery, Pediatric Surgery
Data Matrix	No
Disposable / Reusable	reusable
Sterility	non-sterile
Product contains Latex	No

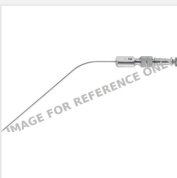

OG983R

PLESTER Suction Cannula, knee-bent, diam. 2 mm, luer attachment, non-sterile, reusable

Product search type	Suction Cannula
Author	PLESTER
Aesculap Product	
Groups	ENT, General Surgical Instruments
Geometry	knee-bent
Diameter (mm)	2.00 mm
Attachment	luer attachment
Discipline	Ear-Nose-Throat Surgery, Hand / Foot Surgery, Pediatric Surgery, Maxillo-Facial Surgery
Data Matrix	No
Disposable / Reusable	reusable
Sterility	non-sterile
Product contains Latex	No



OK876R

EICKEN Irrigation Cannula, slightly curved, 145 mm (5 3/4"), diam. 2,50 mm, blunt, non-sterile, reusable



Product search type	Irrigation Cannula
Author	EICKEN
Aesculap Product	
Groups	ENT, General Surgical Instruments
Geometry	slightly curved
Length	145,00 mm
Length (Inch)	5 3/4
Diameter (mm)	2.50 mm
Tip profile	blunt
Discipline	Maxillo-Facial Surgery, Ear-Nose-Throat Surgery
Data Matrix	Yes
Disposable / Reusable	reusable
Sterility	non-sterile
Product contains Latex	No



OK877R

EICKEN Irrigation Cannula, strongly curved, 145 mm (5 3/4"), diam. 2,50 mm, blunt, non-sterile, reusable



Product search type	Irrigation Cannula
Author	EICKEN
Aesculap Product	
Groups	General Surgical Instruments, ENT
Geometry	strongly curved
Length	145,00 mm
Length (Inch)	5 3/4
Diameter (mm)	2.50 mm
Tip profile	blunt
Discipline	Maxillo-Facial Surgery, Ear-Nose-Throat Surgery
Data Matrix	Yes
Disposable / Reusable	reusable
Sterility	non-sterile
Product contains Latex	No



OK900

HAJEK Irrigation Cannula, straight, 165 mm (6 1/2"), diam. 3,50 mm, silver, luer hub, non-sterile, reusable

Product search type	Irrigation Cannula
Author	HAJEK
Aesculap Product	
Groups	General Surgical Instruments, ENT
Geometry	straight
Length	165,00 mm
Length (Inch)	6 1/2
Diameter (mm)	3.50 mm
Material	silver
Attachment	luer hub
Discipline	Maxillo-Facial Surgery, Ear-Nose-Throat Surgery
Surgical Step	Suction/Irrigation
Data Matrix	No
Disposable / Reusable	reusable
Sterility	non-sterile
Product contains Latex	No



OK875C

EICKEN Irrigation Cannula, 130 mm (5 1/8"), diam. 3 mm, blunt, luer attachment, non-sterile, reusable

Product search type	Irrigation Cannula
Author	EICKEN
Aesculap Product	
Groups	General Surgical Instruments, ENT
Length	130.00 mm
Length (Inch)	5 1/8
Diameter (mm)	3.00 mm
Tip profile	blunt
Attachment	luer attachment
Discipline	Maxillo-Facial Surgery, Ear-Nose-Throat Surgery
Indication	Antrum, Sinus And Hypophysectomy
Surgical Step	Suction/Irrigation
Data Matrix	No
Disposable / Reusable	reusable
Sterility	non-sterile
Product contains Latex	No



OK874C

EICKEN Irrigation Cannula, 130 mm (5 1/8"), diam. 2,50 mm, blunt, non-sterile, reusable

Product search type	Irrigation Cannula
Author	EICKEN
Aesculap Product	
Groups	ENT, General Surgical Instruments
Length	130.00 mm
Length (Inch)	5 1/8
Diameter (mm)	2.50 mm
Tip profile	blunt
Discipline	Ear-Nose-Throat Surgery, Maxillo-Facial Surgery
Indication	Antrum, Sinus And Hypophysectomy
Surgical Step	Suction/Irrigation
Data Matrix	No
Disposable / Reusable	reusable
Sterility	non-sterile
Product contains Latex	No

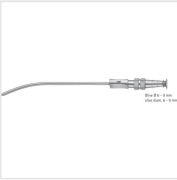

OL187R

GILLIES Suction Cannula, 170 mm (6 3/4"), diam. 3 mm, non-sterile, reusable, for suction hose 6 - 9 mm

Product search type	Suction Cannula
Author	GILLIES
Aesculap Product	
Groups	ENT, General Surgical Instruments
Length	170.00 mm
Length (Inch)	6 3/4
Diameter (mm)	3.00 mm
Connection	
instruments	for suction hose 6 - 9 mm
Discipline	Ear-Nose-Throat Surgery, Maxillo-Facial Surgery
Surgical Step	Suction/Irrigation
Data Matrix	No
Disposable / Reusable	reusable
Sterility	non-sterile
Product contains Latex	No



OL195R

Raspatory, 200 mm (8"), bayonet-shaped, sharp, width: 4 mm, non-sterile, reusable

Product search type	Raspatory
Aesculap Product	
Groups	General Surgical Instruments, ENT
Discipline	Ear-Nose-Throat Surgery
Type of Sterilization	not sterilized ex works
Data Matrix	No
Disposable / Reusable	reusable
Product contains Latex	No
Sterility	non-sterile



OL196R

Suction Raspatory, 200 mm (8"), bayonet-shaped, sharp, width: 5 mm, non-sterile, reusable

Product search type	Suction Raspatory
Aesculap Product	
Groups	General Surgical Instruments, ENT
Discipline	Ear-Nose-Throat Surgery
Type of Sterilization	not sterilized ex works
Data Matrix	No
Disposable / Reusable	reusable
Product contains Latex	No
Sterility	non-sterile



OL168R

GORNEY Suction Tube Dissector, straight, 180 mm (7"), width: 4 mm, non-sterile, reusable

Product search type	Suction Tube Dissector
Author	GORNEY
Aesculap Product	
Groups	General Surgical Instruments, ENT
Discipline	Plastic Surgery, Ear-Nose-Throat Surgery
Type of Sterilization	not sterilized ex works
Data Matrix	No
Disposable / Reusable	reusable
Product contains Latex	No
Sterility	non-sterile



OP362R

Suction Cannula, 250 mm (10"), diam. 3 mm, with finger cut-off, non-sterile, reusable, for suction hose 6 - 9 mm

Product search type	Suction Cannula
Aesculap Product	
Groups	ENT, General Surgical Instruments
Length	250.00 mm
Length (Inch)	10
Diameter (mm)	3.00 mm
Connection	
instruments	for suction hose 6 - 9 mm
Attachment	with finger cut-off
Discipline	Ear-Nose-Throat Surgery
Surgical Step	Suction/Irrigation
Data Matrix	Yes
Disposable / Reusable	reusable
Sterility	non-sterile
Product contains Latex	No



OM672R

ROWBOTHAM Injection Cannula, 295 mm (11 3/4"), with stylet, non-sterile, reusable

Product search type	Injection Cannula
Author	ROWBOTHAM
Aesculap Product	
Groups	General Surgical Instruments, ENT
Length	248.00 mm
Length (Inch)	9 3/4
Attachment	with stylet
Discipline	Ear-Nose-Throat Surgery
Surgical Step	Suction/Irrigation
Data Matrix	No
Disposable / Reusable	reusable
Sterility	non-sterile
Product contains Latex	No



OP360R

Suction Cannula, 250 mm (10"), diam. 2 mm, with finger cut-off, non-sterile, reusable, for suction hose 6 - 9 mm

Product search type	Suction Cannula
Aesculap Product	
Groups	General Surgical Instruments, ENT
Length	250.00 mm
Length (Inch)	10
Diameter (mm)	2.00 mm
Connection	
instruments	for suction hose 6 - 9 mm
Attachment	with finger cut-off
Discipline	Ear-Nose-Throat Surgery
Surgical Step	Suction/Irrigation
Data Matrix	Yes
Disposable / Reusable	reusable
Sterility	non-sterile
Product contains Latex	No

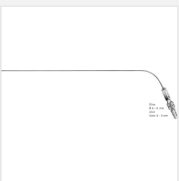

OP361R

Suction Cannula, 250 mm (10"), diam. 2,50 mm, with finger cut-off, non-sterile, reusable, for suction hose 6 - 9 mm

Product search type	Suction Cannula
Aesculap Product	
Groups	General Surgical Instruments, ENT
Length	250.00 mm
Length (Inch)	10
Diameter (mm)	2.50 mm
Connection	
instruments	for suction hose 6 - 9 mm
Attachment	with finger cut-off
Discipline	Ear-Nose-Throat Surgery
Surgical Step	Suction/Irrigation
Data Matrix	Yes
Disposable / Reusable	reusable
Sterility	non-sterile
Product contains Latex	No

По вопросам продаж и поддержки обращайтесь:

Алматы (7273)495-231	Казань (843)206-01-48	Новокузнецк (3843)20-46-81	Смоленск (4812)29-41-54
Архангельск (8182)63-90-72	Калининград (4012)72-03-81	Новосибирск (383)227-86-73	Сочи (862)225-72-31
Астрахань (8512)99-46-04	Калуга (4842)92-23-67	Омск (3812)21-46-40	Ставрополь (8652)20-65-13
Барнаул (3852)73-04-60	Кемерово (3842)65-04-62	Орел (4862)44-53-42	Сургут (3462)77-98-35
Белгород (4722)40-23-64	Киров (8332)68-02-04	Оренбург (3532)37-68-04	Тверь (4822)63-31-35
Брянск (4832)59-03-52	Краснодар (861)203-40-90	Пенза (8412)22-31-16	Томск (3822)98-41-53
Владивосток (423)249-28-31	Красноярск (391)204-63-61	Пермь (342)205-81-47	Тула (4872)74-02-29
Волгоград (844)278-03-48	Курск (4712)77-13-04	Ростов-на-Дону (863)308-18-15	Тюмень (3452)66-21-18
Вологда (8172)26-41-59	Липецк (4742)52-20-81	Рязань (4912)46-61-64	Ульяновск (8422)24-23-59
Воронеж (473)204-51-73	Магнитогорск (3519)55-03-13	Самара (846)206-03-16	Уфа (347)229-48-12
Екатеринбург (343)384-55-89	Москва (495)268-04-70	Санкт-Петербург (812)309-46-40	Хабаровск (4212)92-98-04
Иваново (4932)77-34-06	Мурманск (8152)59-64-93	Саратов (845)249-38-78	Челябинск (351)202-03-61
Ижевск (3412)26-03-58	Набережные Челны (8552)20-53-41	Севастополь (8692)22-31-93	Череповец (8202)49-02-64
Иркутск (395)279-98-46	Нижний Новгород (831)429-08-12	Симферополь (3652)67-13-56	Ярославль (4852)69-52-93
Россия (495)268-04-70	Киргизия (996)312-96-26-47	Казахстан (7172)727-132	