

# АТРАУМАТА

## Технические характеристики

### По вопросам продаж и поддержки обращайтесь:

Алматы (7273)495-231	Казань (843)206-01-48	Новокузнецк (3843)20-46-81	Смоленск (4812)29-41-54
Архангельск (8182)63-90-72	Калининград (4012)72-03-81	Новосибирск (383)227-86-73	Сочи (862)225-72-31
Астрахань (8512)99-46-04	Калуга (4842)92-23-67	Омск (3812)21-46-40	Ставрополь (8652)20-65-13
Барнаул (3852)73-04-60	Кемерово (3842)65-04-62	Орел (4862)44-53-42	Сургут (3462)77-98-35
Белгород (4722)40-23-64	Киров (8332)68-02-04	Оренбург (3532)37-68-04	Тверь (4822)63-31-35
Брянск (4832)59-03-52	Краснодар (861)203-40-90	Пенза (8412)22-31-16	Томск (3822)98-41-53
Владивосток (423)249-28-31	Красноярск (391)204-63-61	Пермь (342)205-81-47	Тула (4872)74-02-29
Волгоград (844)278-03-48	Курск (4712)77-13-04	Ростов-на-Дону (863)308-18-15	Тюмень (3452)66-21-18
Вологда (8172)26-41-59	Липецк (4742)52-20-81	Рязань (4912)46-61-64	Ульяновск (8422)24-23-59
Воронеж (473)204-51-73	Магнитогорск (3519)55-03-13	Самара (846)206-03-16	Уфа (347)229-48-12
Екатеринбург (343)384-55-89	Москва (495)268-04-70	Санкт-Петербург (812)309-46-40	Хабаровск (4212)92-98-04
Иваново (4932)77-34-06	Мурманск (8152)59-64-93	Саратов (845)249-38-78	Челябинск (351)202-03-61
Ижевск (3412)26-03-58	Набережные Челны (8552)20-53-41	Севастополь (8692)22-31-93	Череповец (8202)49-02-64
Иркутск (395)279-98-46	Нижний Новгород (831)429-08-12	Симферополь (3652)67-13-56	Ярославль (4852)69-52-93
Россия (495)268-04-70	Киргизия (996)312-96-26-47	Казахстан (7172)727-132	



DE BAKEY Zahnung



Toothing DE BAKEY

AIRAUMATA®

## Herz- und Gefäß-Chirurgie – Cardiovascular Surgery

Ultra-Light-Pinzetten

Ultra-Light-Forceps

FB

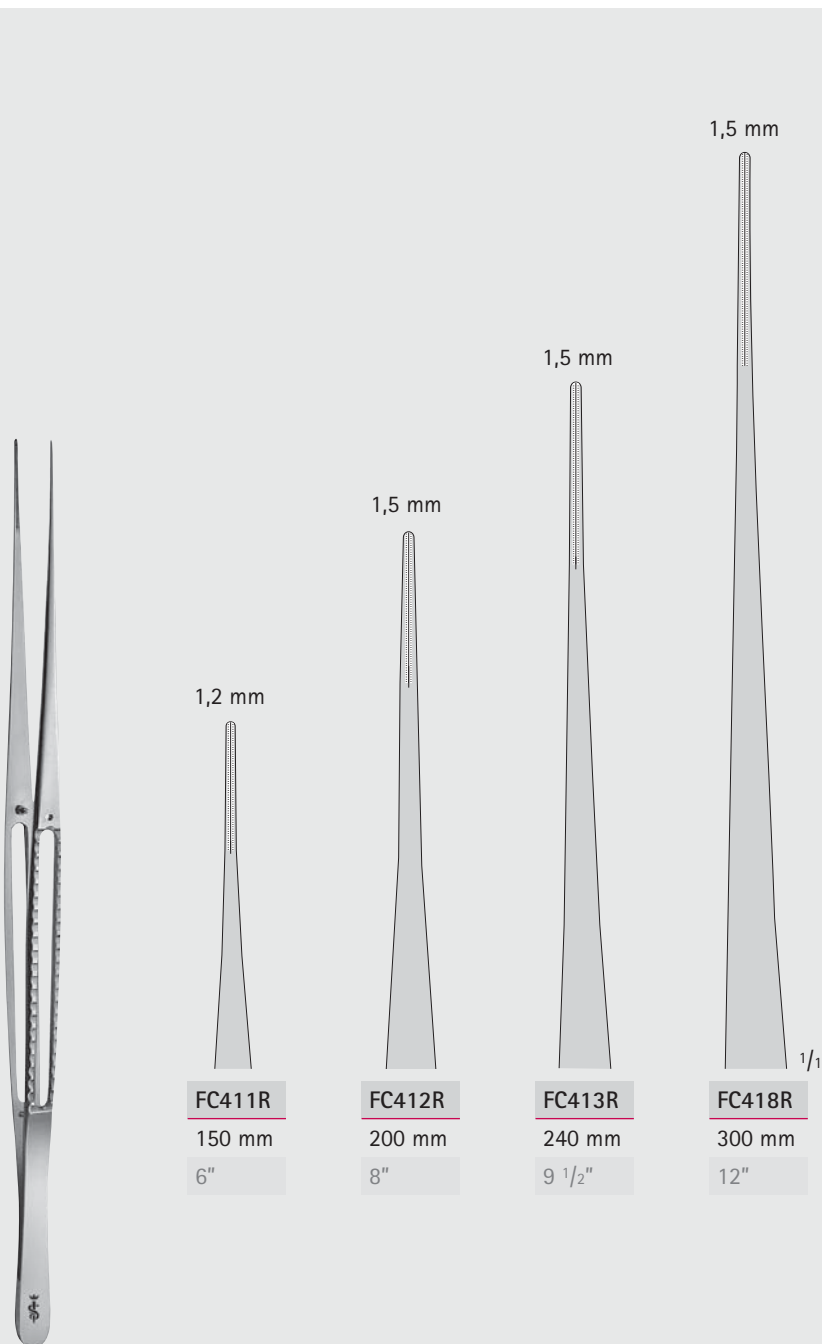
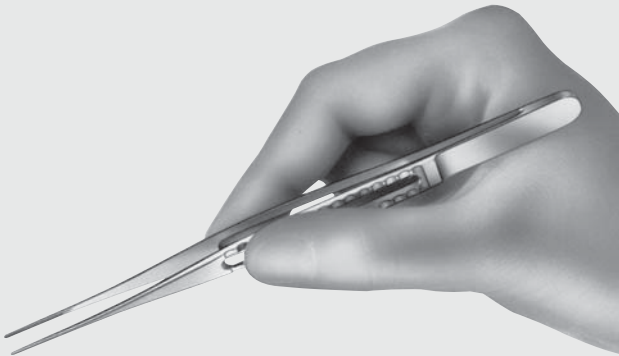

**FC411R**  
150 mm  
6"

**FC412R**  
200 mm  
8"

**FC413R**  
240 mm  
9 1/2"

**FC418R**  
300 mm  
12"

DE BAKEY

FC411R-FC418R

MILLIMETERS

# Herz- und Gefäß-Chirurgie – Cardiovascular Surgery

Pinzetten  
Forceps

DE BAKEY Zahnung



**ARAUMATA**® Toothing DE BAKEY

FB

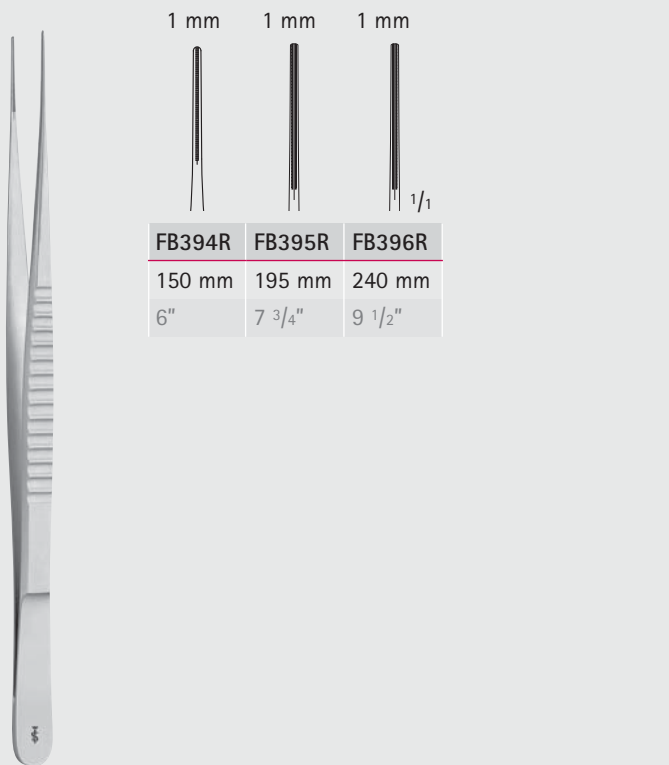

FB394R	FB395R	FB396R
150 mm	195 mm	240 mm
6"	7 3/4"	9 1/2"

DE BAKEY

**FB394R-FB396R**

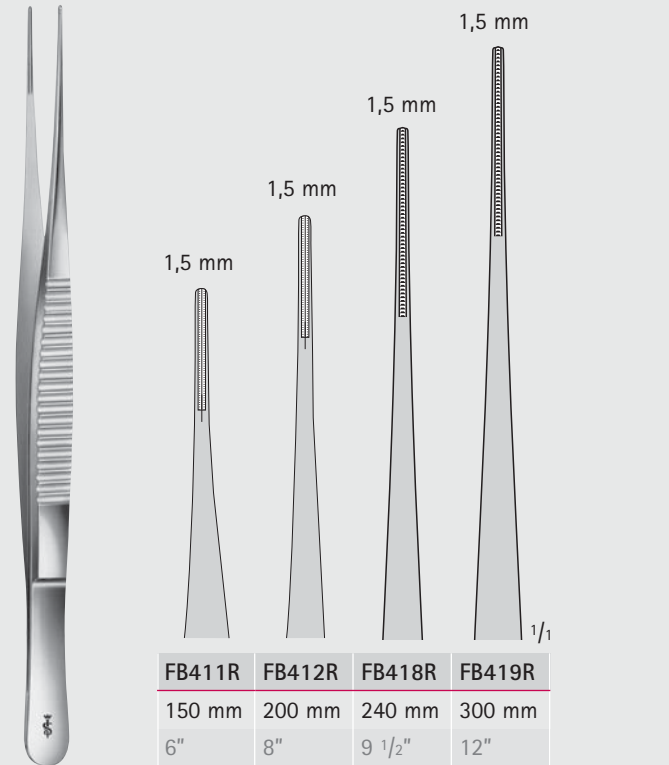

FB411R	FB412R	FB418R	FB419R
150 mm	200 mm	240 mm	300 mm
6"	8"	9 1/2"	12"

DE BAKEY

**FB411R-FB419R**

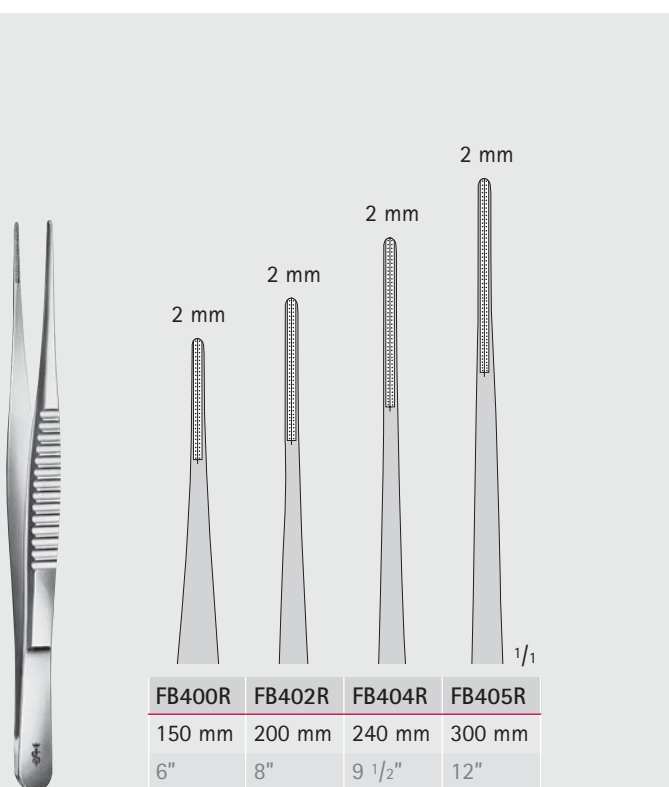

FB400R	FB402R	FB404R	FB405R
150 mm	200 mm	240 mm	300 mm
6"	8"	9 1/2"	12"

DE BAKEY

**FB400R-FB405R**

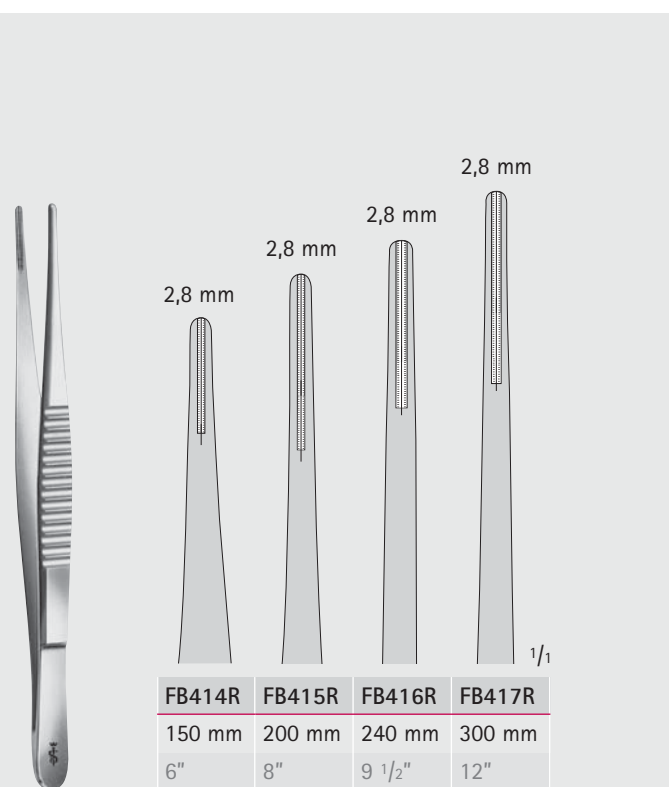

FB414R	FB415R	FB416R	FB417R
150 mm	200 mm	240 mm	300 mm
6"	8"	9 1/2"	12"

DE BAKEY

**FB414R-FB417R**

INCHES



DE BAKEY Zahnung



Toothing DE BAKEY

AIRAUMATA®

# Herz- und Gefäß-Chirurgie – Cardiovascular Surgery

Pinzetten

Forceps

FB

FB406R	FB407R	FB408R	FB409R
200 mm	240 mm	300 mm	350 mm
8"	9 1/2"	12"	14"

DE BAKEY  
FB406R-FB409R

COOLEY Zahnung

Toothing COOLEY

FB784R	FB785R	FB786R
150 mm	195 mm	240 mm
6"	7 3/4"	9 1/2"

COOLEY  
FB784R-FB786R

DE BAKEY  
FB401R  
150 mm, 6"

DE BAKEY  
FB403R  
200 mm, 8"

COOLEY  
BD250R  
200 mm, 8"



# Herz- und Gefäß-Chirurgie – Cardiovascular Surgery

Bulldogklemmen mit Ringgriffen

Ring Handle Bulldog Clamps

DE BAKEY Zahnung



Toothing DE BAKEY

AIRAUMATA®

FB



DE BAKEY

**FB540R**

gerade

straight

130 mm, 5 1/8"



DE BAKEY

**FB541R**

Maul gebogen

curved jaws

125 mm, 5"

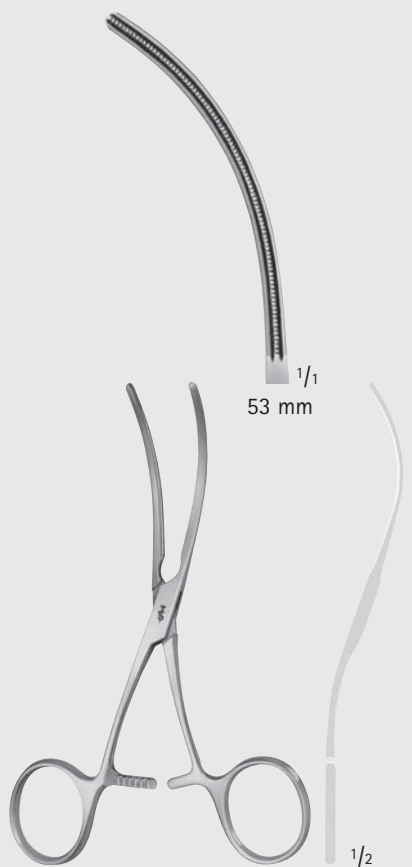

DE BAKEY

**FB542R**

S-förmig

S-shaped

125 mm, 5"

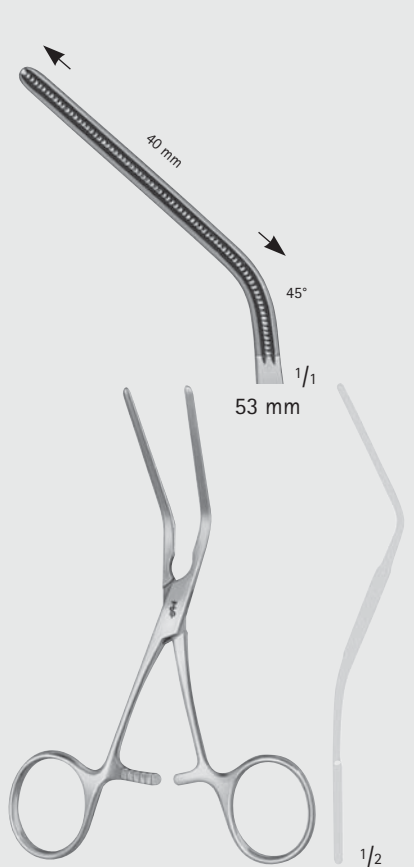

DE BAKEY

**FB543R**

45° winklig gebogen

angled 45°

125 mm, 5"

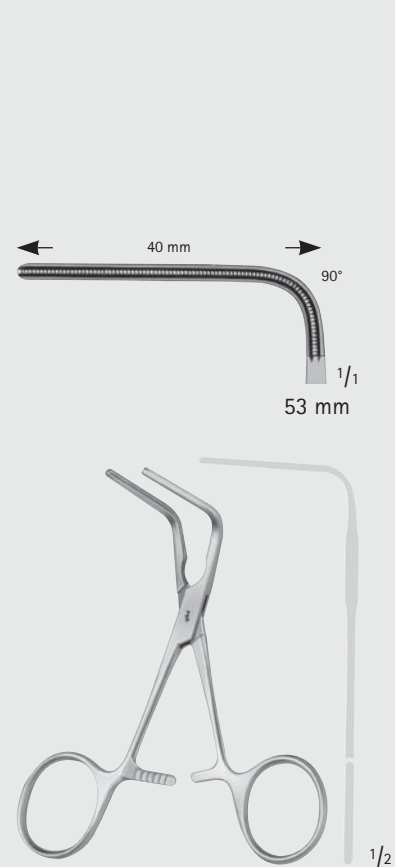

DE BAKEY

**FB544R**

90° winklig gebogen

angled 90°

105 mm, 4 1/8"



DE BAKEY Zahnung



Toothing DE BAKEY

**AIRAUMATA®**

# Herz- und Gefäß-Chirurgie – Cardiovascular Surgery

Anastomosen-, Mehrzweckklemmen für Neugeborene  
Anastomosis-, Multi-Purpose-Clamps for Neonatales

**FB**

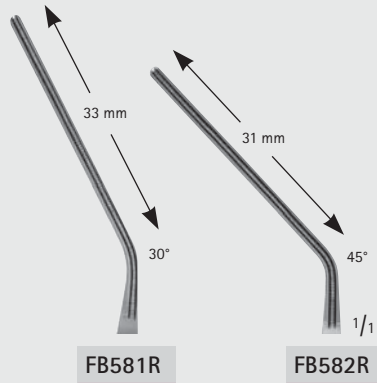

CASTANEDA

**FB581R-FB582R**

120 mm, 4 3/4"



CASTANEDA

**FB590R-FB593R**

155 mm, 6"

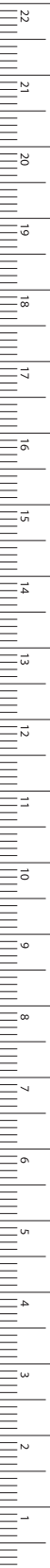

MILLIMETERS

# Herz- und Gefäß-Chirurgie – Cardiovascular Surgery

Anastomosen- und Mehrzweckklemmen - Kinder-Modelle

Anastomosis- and Multi-Purpose-Clamps - Pediatric Patterns

AIRAUMATA®

DE BAKEY Zahnung



Toothing DE BAKEY

FB

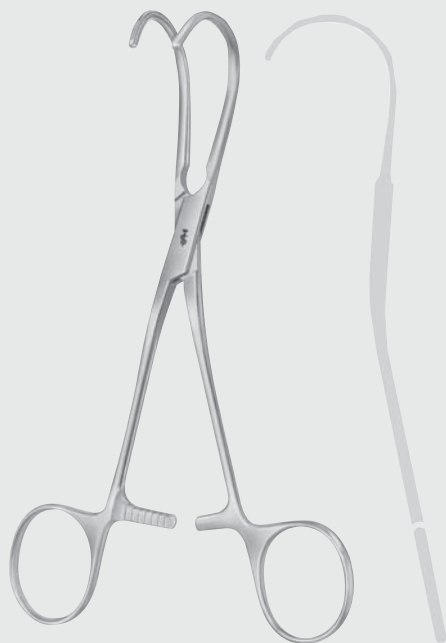

DE BAKEY

FB557R-FB558R

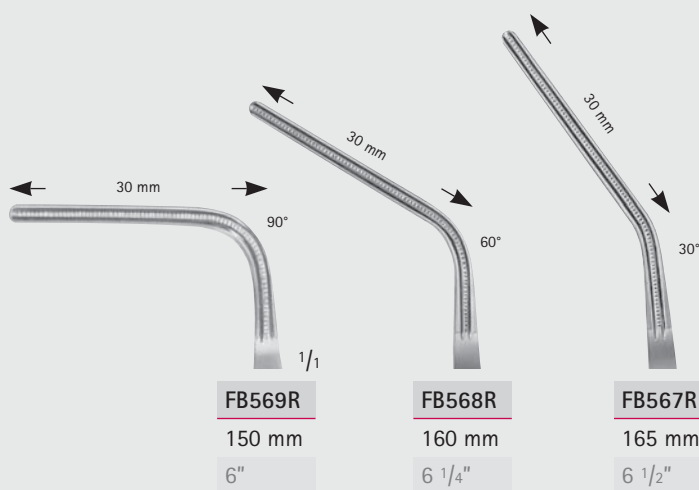

COOLEY

FB567R-FB569R



DE BAKEY Zahnung



Toothing DE BAKEY

AIRAUMATA®

## Herz- und Gefäß-Chirurgie – Cardiovascular Surgery

Anastomosen-, Mehrzweckklemmen - Kinder-Modelle

Anastomosis-, Multi-Purpose-Clamps - Pediatric Patterns

FB



FB559R

170 mm

6 3/4"



FB560R

170 mm

6 3/4"

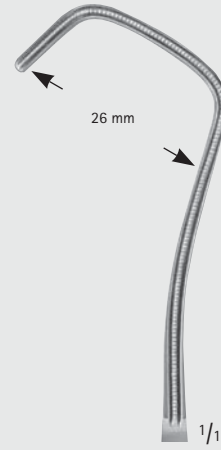

FB561R

175 mm

7"

DERRA

FB559R-FB561R

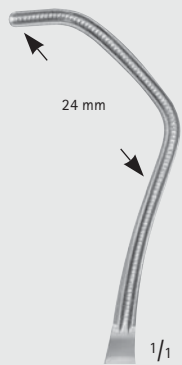

1/1

1/2

COOLEY

FB563R

160 mm, 6 1/4"

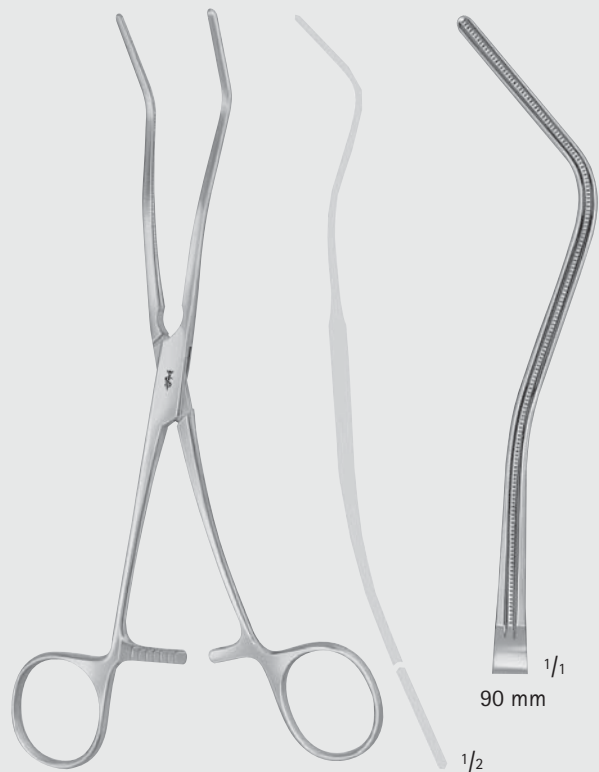

1/1  
90 mm

1/2

COOLEY

FB570R

200 mm, 8"

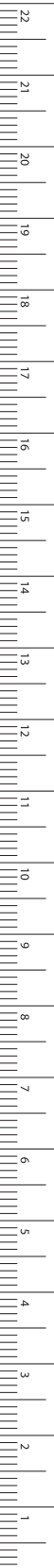

MILLIMETERS



# Herz- und Gefäß-Chirurgie – Cardiovascular Surgery

## Gefäßklemmen

### Hemostatic Forceps

DE BAKEY Zahnung



Toothing DE BAKEY

AIRAUMATA®

FB

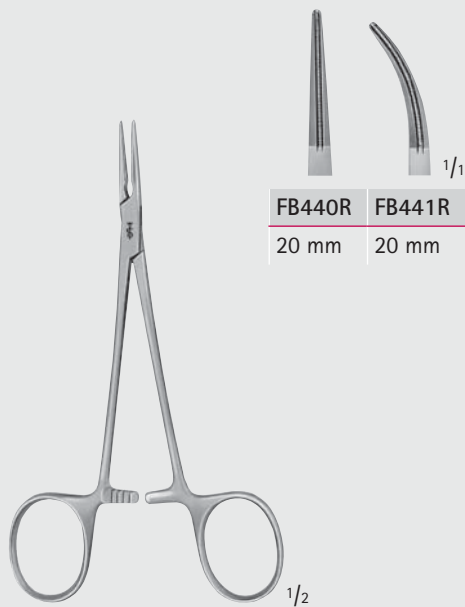

FB440R	FB441R
20 mm	20 mm

**FB440R-FB441R**  
Mosquitoklemmen  
Mosquito Forceps  
125 mm, 5"

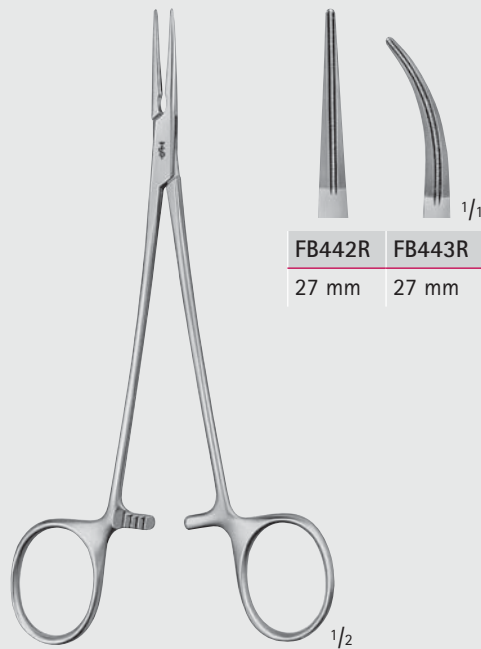

FB442R	FB443R
27 mm	27 mm

**FB442R-FB443R**  
Mosquitoklemmen  
Mosquito forceps  
165 mm, 6 1/2"



FB446R	FB447R
40 mm	40 mm

**FB446R-FB447R**  
DE BAKEY-BAINBRIDGE  
155 mm, 6"



FB448R	FB449R
65 mm	65 mm

**FB448R-FB449R**  
DE BAKEY-BAINBRIDGE  
180 mm, 7"



DE BAKEY Zahnung



Toothing DE BAKEY

AIRAUMATA®

# Herz- und Gefäß-Chirurgie – Cardiovascular Surgery

Gefäßklemmen

Hemostatic Forceps

FB

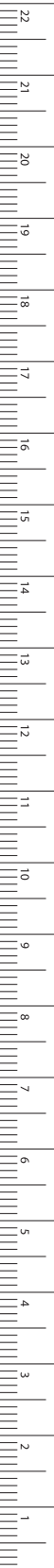

MILLIMETERS

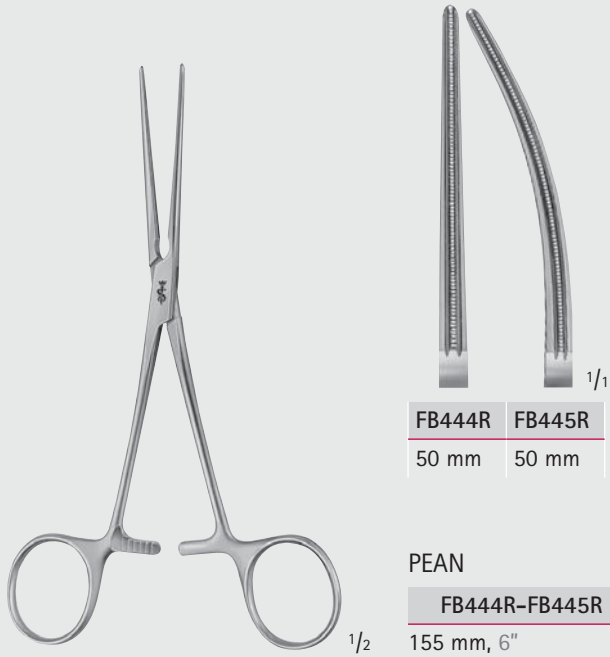

FB444R	FB445R
50 mm	50 mm

PEAN  
**FB444R-FB445R**  
 155 mm, 6"



FB526R	FB532R	FB534R
60 mm	89 mm	99 mm
200 mm	265 mm	280 mm
8"	10 1/2"	11"

FB527R	FB533R	FB535R
60 mm	89 mm	99 mm
200 mm	260 mm	275 mm
8"	10 1/4"	10 3/4"

DE BAKEY-PEAN

**FB526R-FB535R**

# Herz- und Gefäß-Chirurgie – Cardiovascular Surgery

Klemmen für Nieren- und Pankreasingriffe

Kidney and Pankreas Clamps

DE BAKEY Zahnung



Toothing DE BAKEY

ARAUMATA®

FB

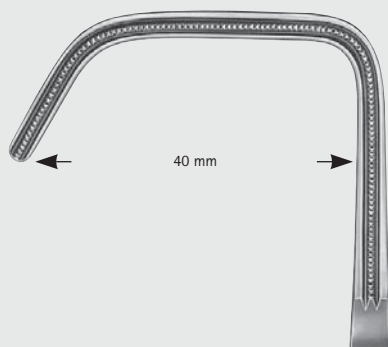

FB528R

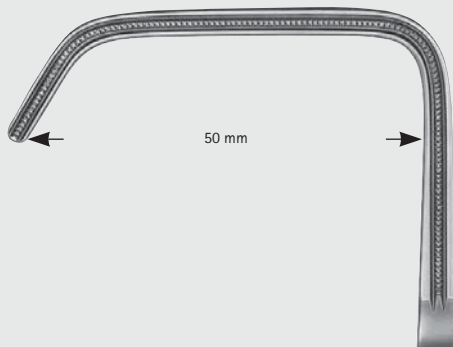

FB529R



FB530R

HOPT

FB528R	230 mm	9"
FB529R	235 mm	9 1/4"
FB530R	245 mm	9 3/4"



DE BAKEY Zahnung



Toothing DE BAKEY

AIRAUMATA®

## Herz- und Gefäß-Chirurgie – Cardiovascular Surgery

Präparier- und Ligaturklemmen

Dissecting- and Ligature Forceps



**FB486R**  
81 mm

**FB487R**  
81 mm

1/1

80 mm  
1/1

70 mm  
1/1



DE BAKEY-RUMEL

<b>FB486R</b>	250 mm	10"
<b>FB487R</b>	245 mm	9 3/4"

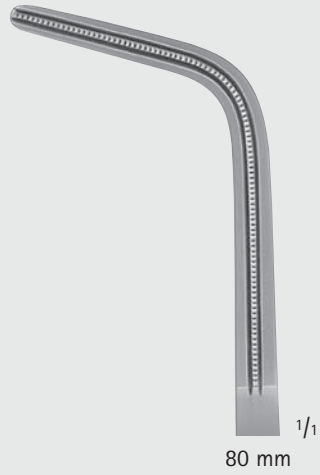

DE BAKEY-MIXTER

**FB497R**  
285 mm, 11 1/4"

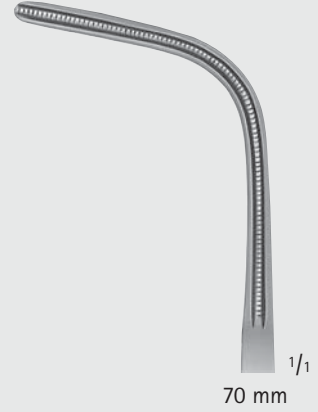

DE BAKEY-MC QUIGG-MIXTER

**FB496R**  
210 mm, 8 1/4"

FB

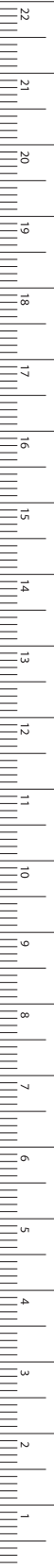

MILLIMETERS

# Herz- und Gefäß-Chirurgie – Cardiovascular Surgery

Präparier- und Ligaturklemmen, Profunda Klemmen

Dissecting- and Ligature Forceps, Profunda Clamps

DE BAKEY Zahnung



Toothing DE BAKEY

**AIRAUMATA**<sup>®</sup>

FB

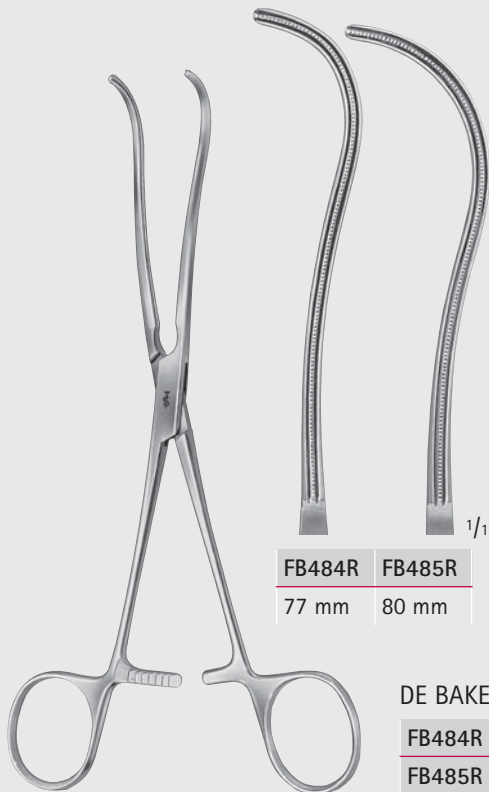

FB484R	FB485R
77 mm	80 mm

DE BAKEY

FB484R	190 mm	7 1/2"
FB485R	230 mm	9"

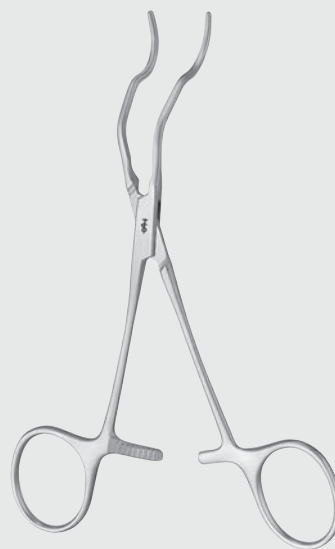

GREGORY

MB750R	57 mm
MB751R	62 mm

Profunda Klemmen

Profunda clamps

200 mm, 8"

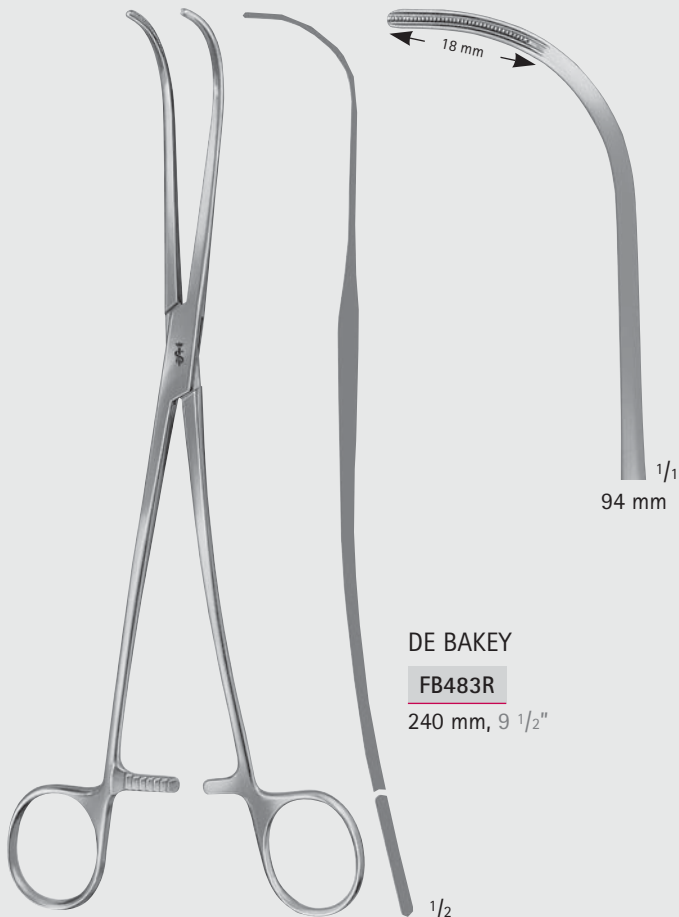

DE BAKEY

FB483R	240 mm, 9 1/2"
--------	----------------



FB498R	FB499R
51 mm	75 mm

DE BAKEY

FB498R	210 mm	8 1/4"
FB499R	230 mm	9"



DE BAKEY Zahnung



Toothing DE BAKEY

AIRAUMATA®

# Herz- und Gefäß-Chirurgie – Cardiovascular Surgery

Anastomosenklemmen

Anastomosis Clamps

FB

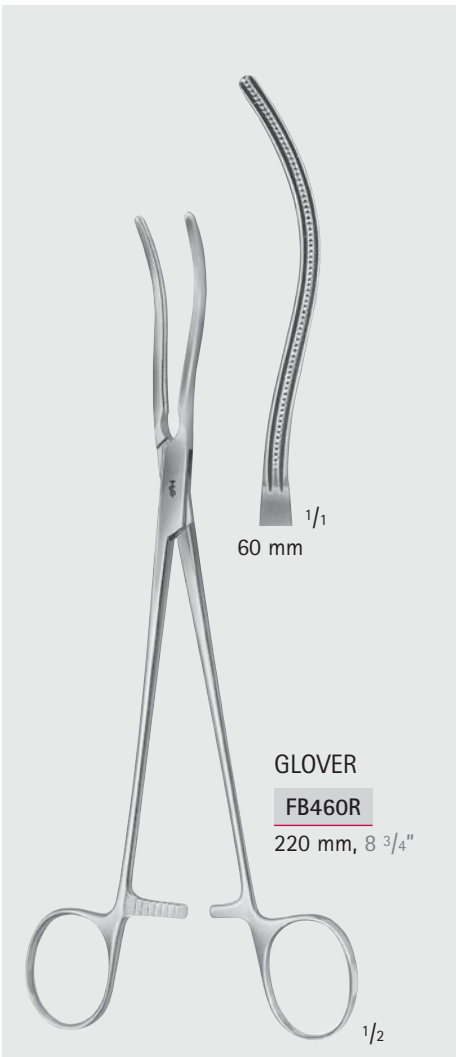
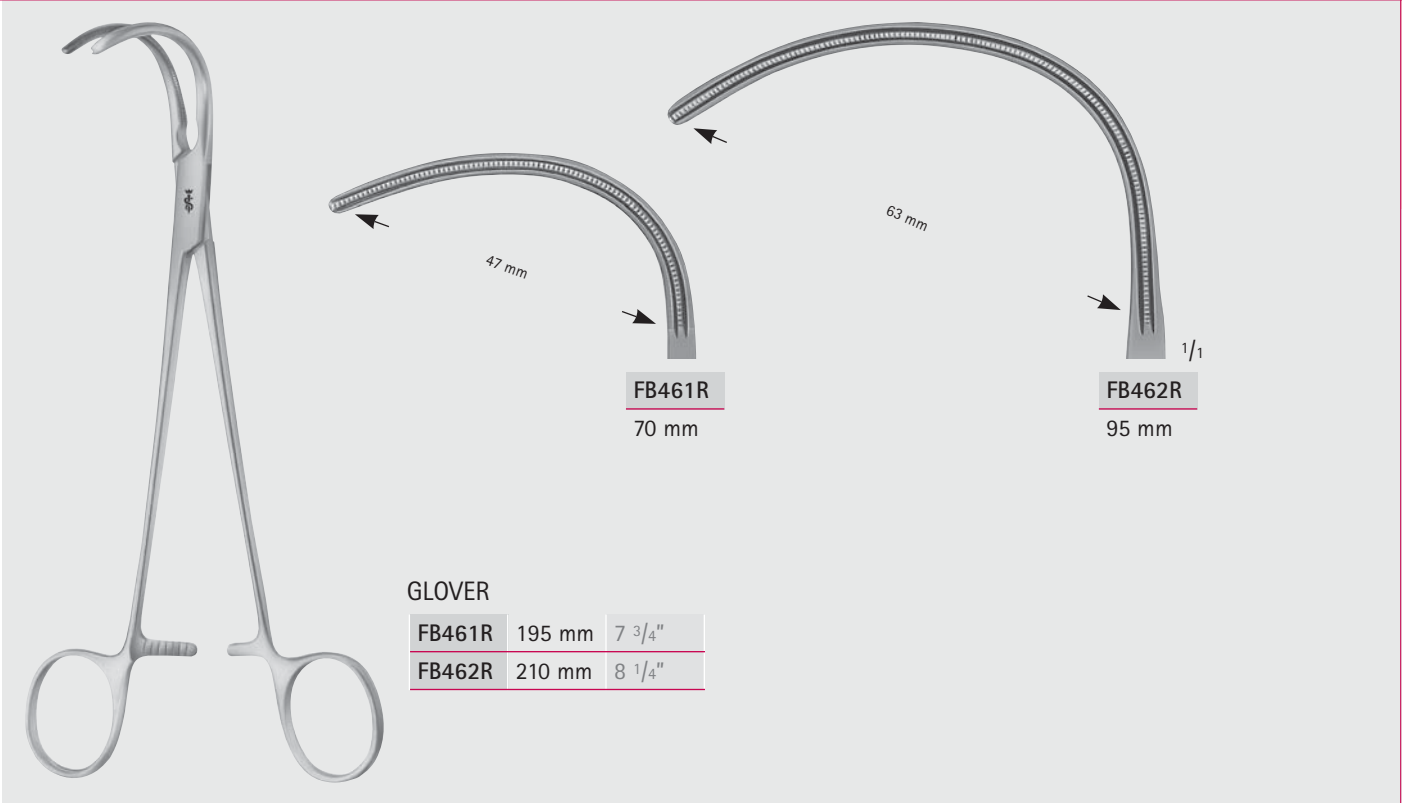

MILLIMETERS

# Herz- und Gefäß-Chirurgie – Cardiovascular Surgery

Vena-Cava-Klemmen

Vena Cava Clamps

DE BAKEY Zahnung



Toothing DE BAKEY

AIRAUMATA®

FB

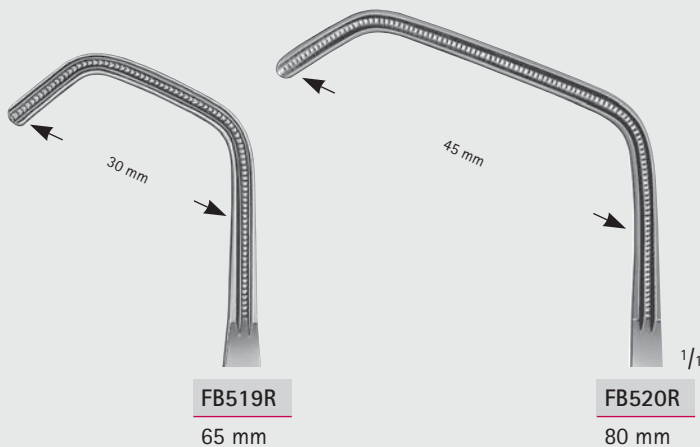

### DE BAKEY-BECK

FB519R	205 mm	8"
FB520R	210 mm	8 1/4"

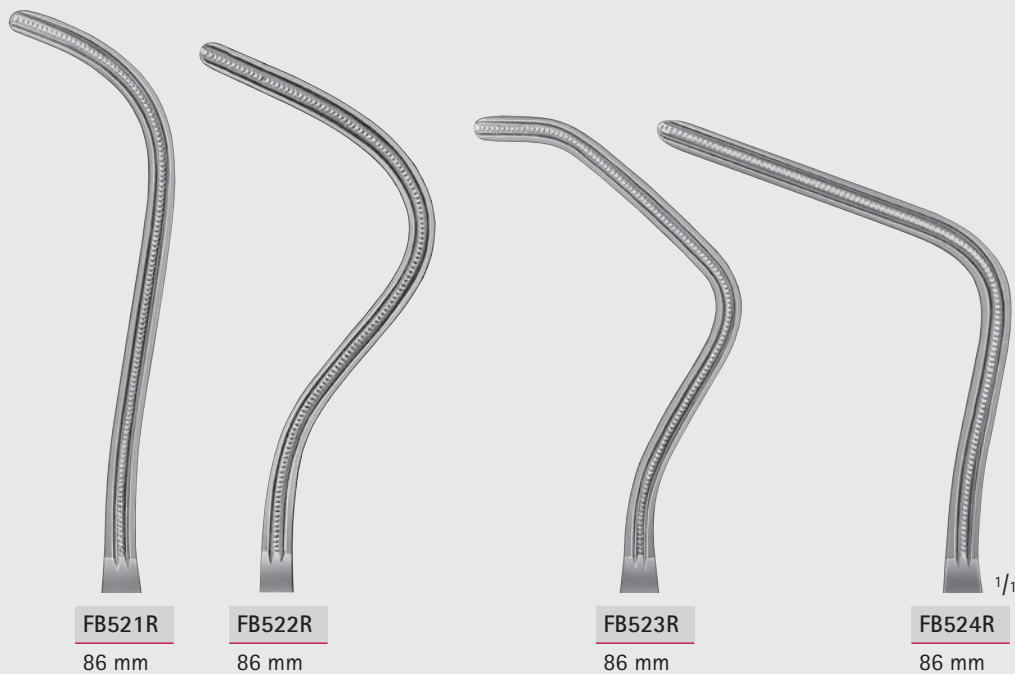

### DE BAKEY-HARKEN

FB521R	255 mm	10"
FB522R	245 mm	9 3/4"
FB523R	245 mm	9 3/4"
FB524R	245 mm	9 3/4"



DE BAKEY Zahnung



Toothing DE BAKEY

AIRAUMATA®

## Herz- und Gefäß-Chirurgie – Cardiovascular Surgery

Gefäßklemmen für Tangential-Verschluss

Tangential Occlusion Clamps

FB

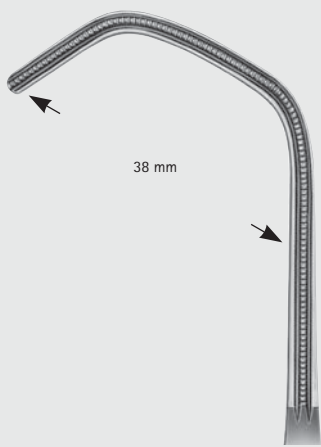

FB500R

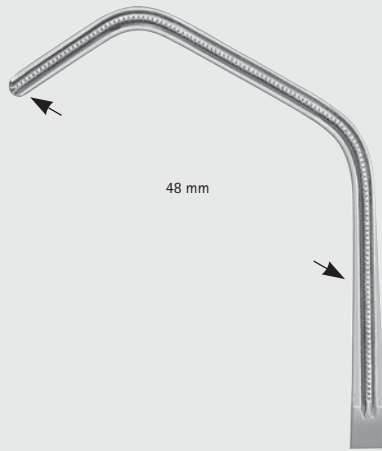

FB501R



FB502R

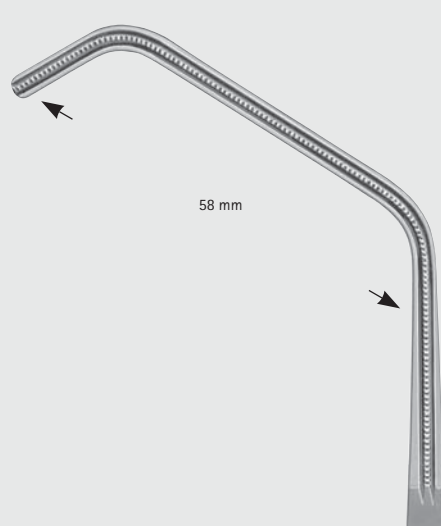

FB503R

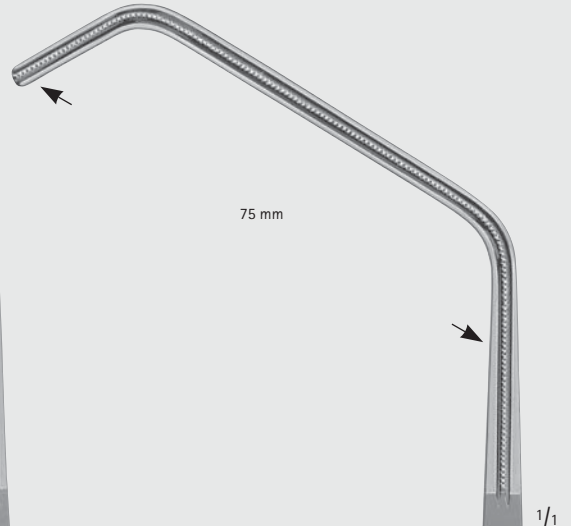

FB504R



DE BAKEY

Gesamtlänge:

Total Length:

Maullänge:

Jaw length:

	FB500R	FB501R	FB502R	FB503R	FB504R
Gesamtlänge:	220 mm	265 mm	270 mm	270 mm	280 mm
Total Length:	7 3/4"	10 1/4"	10 3/4"	10 3/4"	11"
Maullänge:	85 mm	95 mm	99 mm	103 mm	119 mm
Jaw length:	3 3/8"	3 3/4"	4"	4 1/8"	4 3/4"

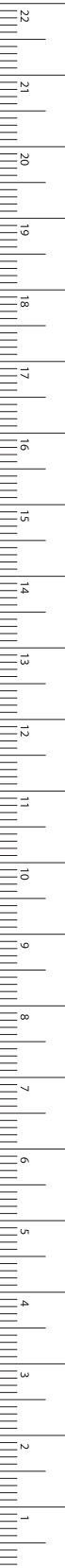

MILLIMETERS



**Herz- und Gefäß-Chirurgie – Cardiovascular Surgery**  
 Gefäßklemmen für Tangential-Verschluss  
 Tangential Occlusion Clamps

DE BAKEY Zahnung



Toothing DE BAKEY

**AIRAUMATA®**

**FB**

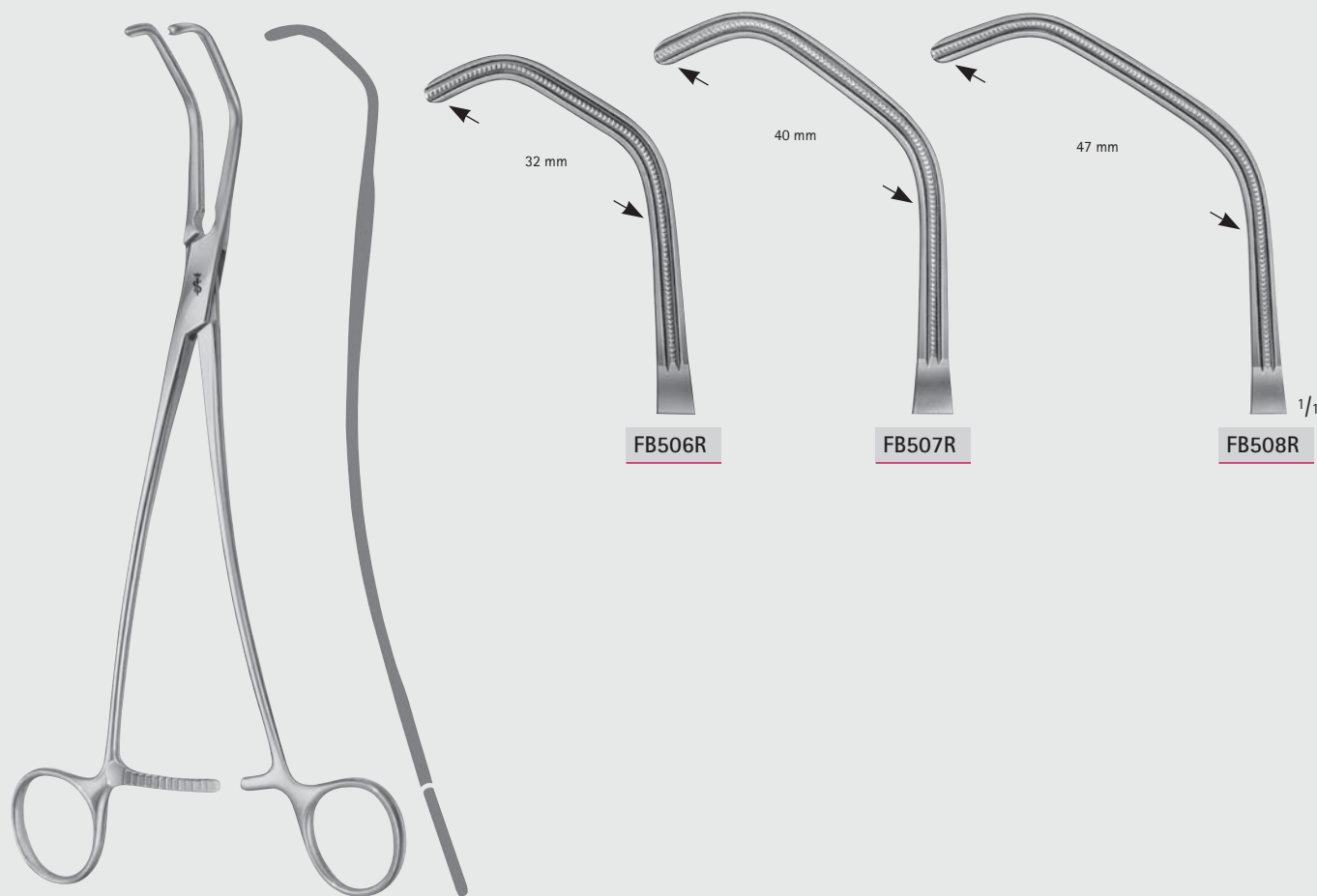

**DE BAKEY-SATINSKY**

	<b>FB506R</b>	<b>FB507R</b>	<b>FB508R</b>
Gesamtlänge:	235 mm	240 mm	245 mm
Total Length:	9 1/4"	9 1/2"	9 3/4"
Maullänge:	68 mm	76 mm	84 mm
Jaw length:	2 3/4"	3"	3 3/8"



DE BAKEY Zahnung



Toothing DE BAKEY

AIRAUMATA®

## Herz- und Gefäß-Chirurgie – Cardiovascular Surgery

Gefäßklemmen

Hemostatic Forceps

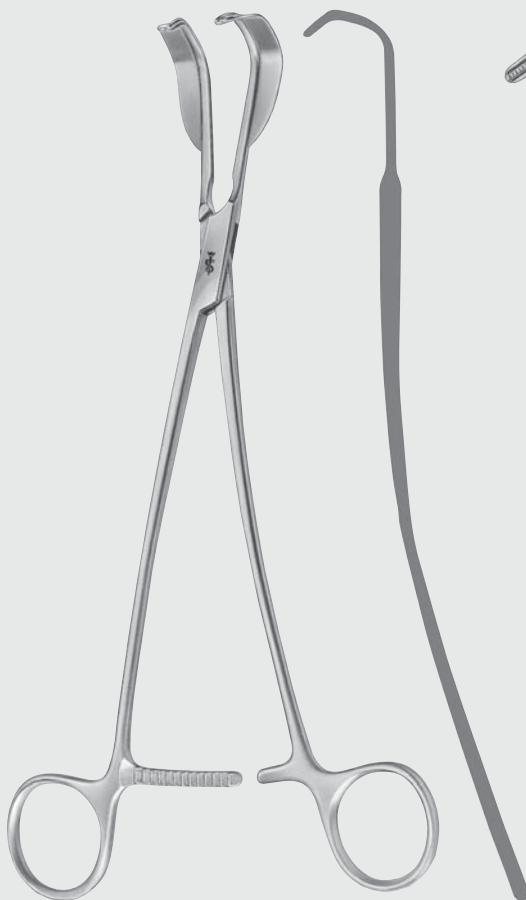
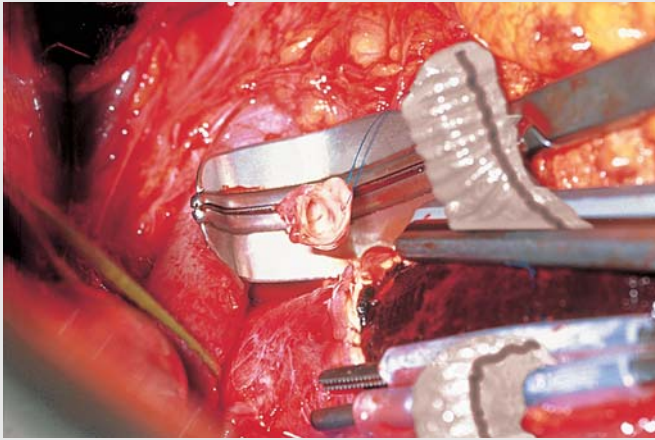

ALLENBERG

**FB587R-FB588R**

mit Retraktionsblättern zum Weghalten von Weichteilen während der Anastomose  
with retraction blades for retraction of soft tissue during the anastomosis



FB

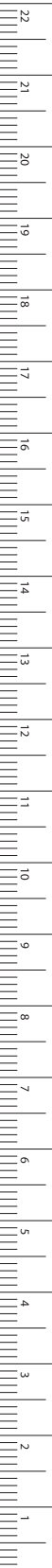

MILLIMETERS

# Herz- und Gefäß-Chirurgie – Cardiovascular Surgery

## Coarctationsklemmen

### Coarctation Clamps

DE BAKEY Zahnung



Toothing DE BAKEY

AIRAUMATA®

FB

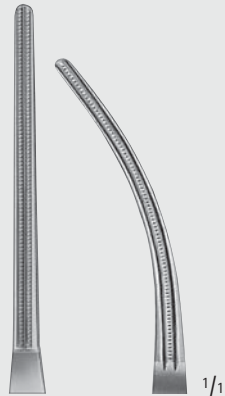

FB552R	FB554R
50 mm	50 mm

DE BAKEY

FB552R	170 mm	6 3/4"
FB554R	165 mm	6 1/2"

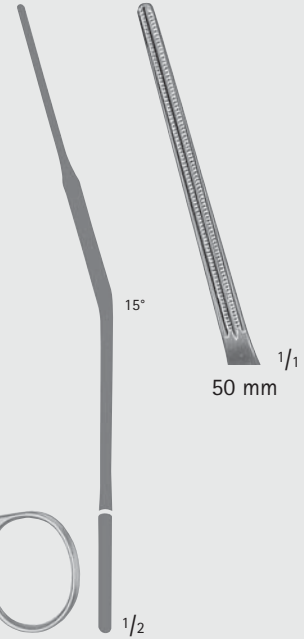

DE BAKEY

FB553R	165 mm, 6 1/2"
--------	----------------

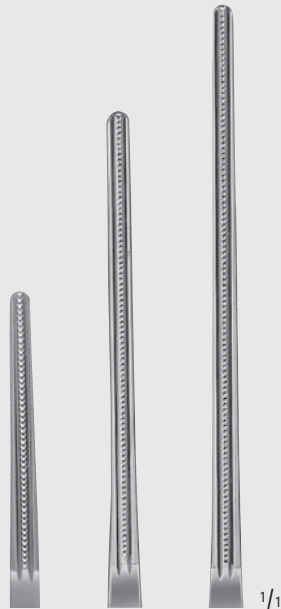

FB452R	FB454R	FB456R
41 mm	65 mm	80 mm

DE BAKEY

FB452R	205 mm	8"
FB454R	225 mm	9"
FB456R	240 mm	9 1/2"

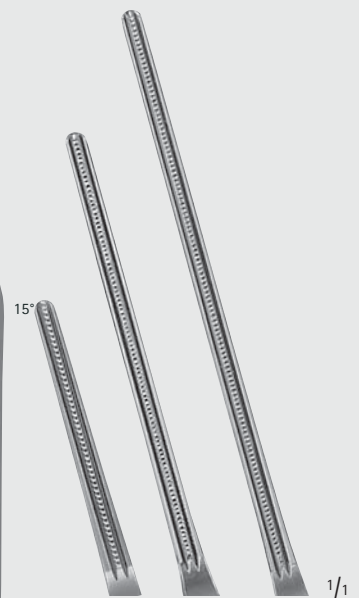

FB453R	FB455R	FB457R
41 mm	65 mm	80 mm

DE BAKEY

FB453R	200 mm	8"
FB455R	225 mm	9"
FB457R	240 mm	9 1/2"



DE BAKEY Zahnung



Toothing DE BAKEY

AIRAUMATA®

## Herz- und Gefäß-Chirurgie – Cardiovascular Surgery

Patent-Ductusklemmen, Peripheralklemmen

Patent-Ductus-Clamps, Peripheral-Vascular-Clamps

FB



DE BAKEY

FB450R

210 mm, 8 1/4"

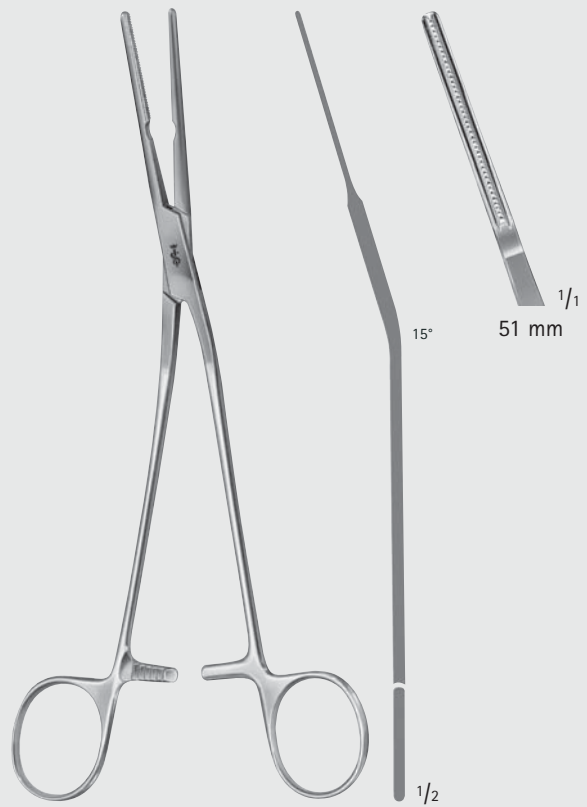

DE BAKEY

FB451R

210 mm, 8 1/4"



MILLIMETERS

# Herz- und Gefäß-Chirurgie – Cardiovascular Surgery

Patent-Ductusklemmen, Peripheralklemmen

Patent-Ductus-Clamps, Peripheral-Vascular-Clamps

DE BAKEY Zahnung



Toothing DE BAKEY

AIRAUMATA®

FB

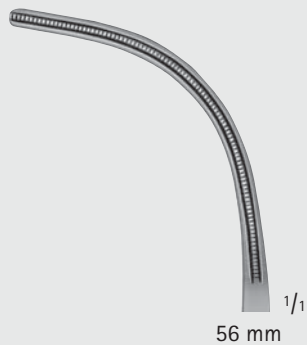

56 mm

1/1

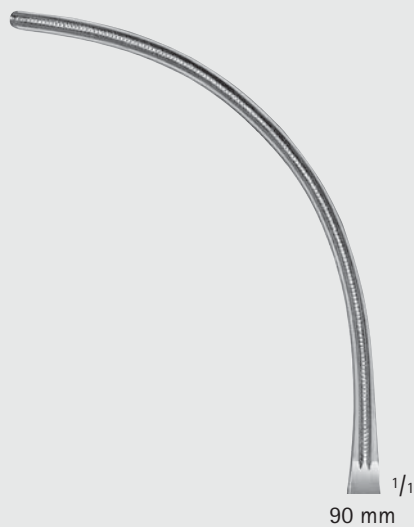

90 mm

1/1

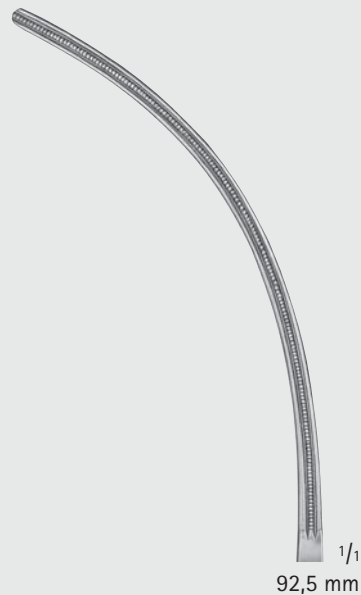

92,5 mm

1/1



1/2

DE BAKEY

FB463R

160 mm, 6 1/4"

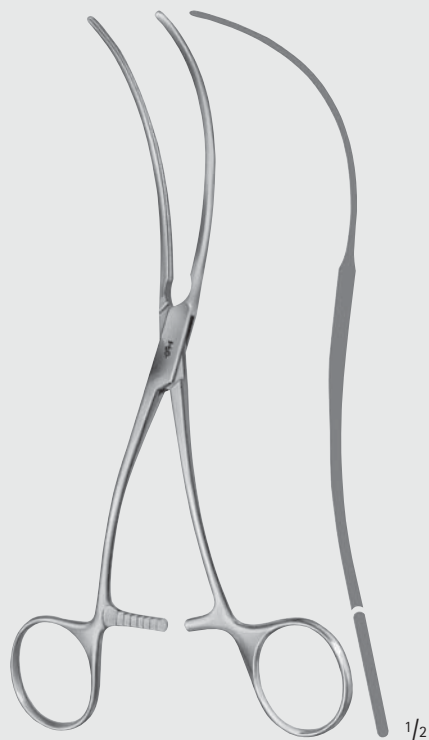

1/2

DE BAKEY

FB464R

190 mm, 7 1/4"

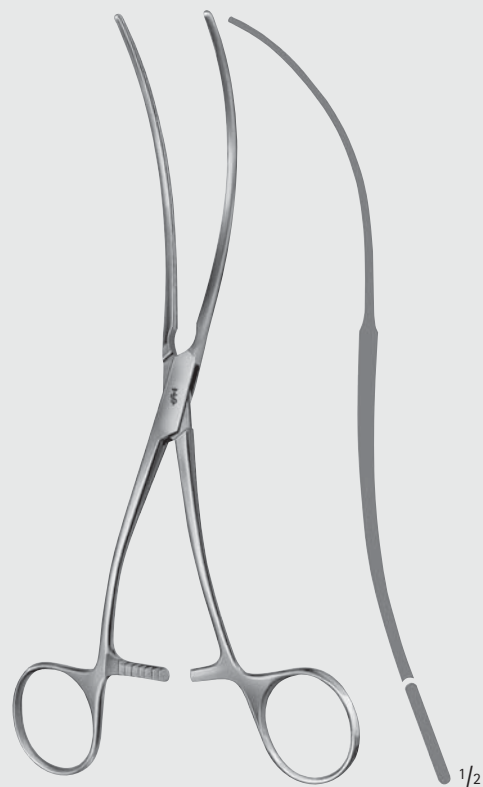

1/2

DE BAKEY

FB465R

200 mm, 8"



DE BAKEY Zahnung



Toothing DE BAKEY

AIRAUMATA®

# Herz- und Gefäß-Chirurgie – Cardiovascular Surgery

Peripheralklemmen

Peripheral-Vascular-Clamps

FB

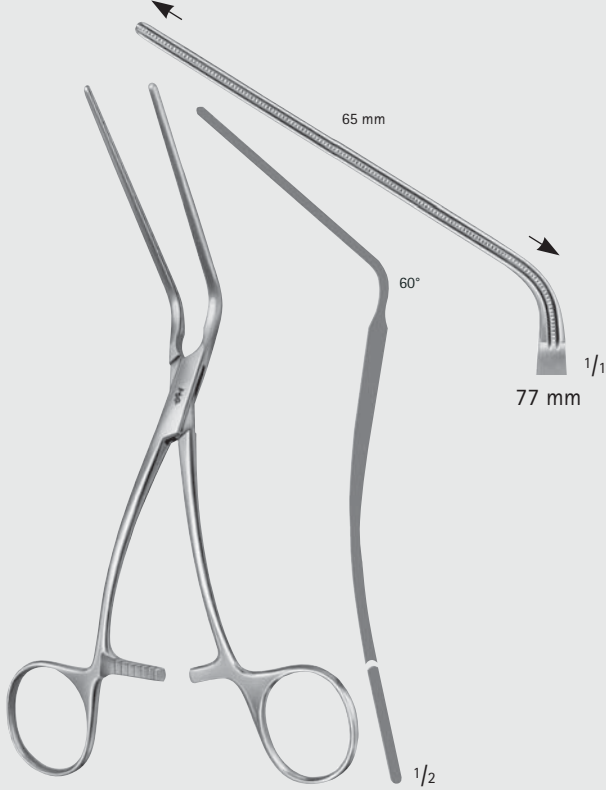

DE BAKEY

**FB466R**

180 mm, 7"



LELAND-JONES

**FB467R-FB468R**

190 mm, 7 1/2"

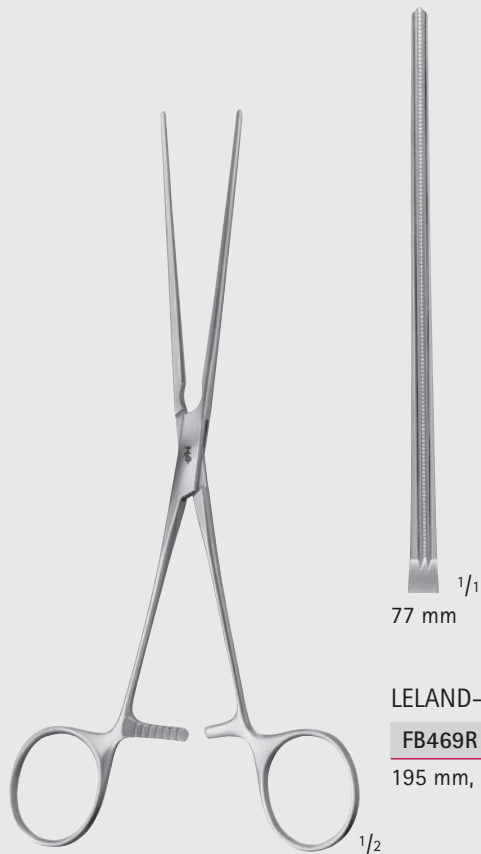

LELAND-JONES

**FB469R**

195 mm, 7 3/4"



DE BAKEY

**FB470R**

Iliaca-Klemme

Iliac clamp

200 mm, 8"



MILLIMETERS



DE BAKEY Zahnung



Toothing DE BAKEY

AIRAUMATA®

# Herz- und Gefäß-Chirurgie – Cardiovascular Surgery

Mehrzweckklemmen

Multi-Purpose-Clamps

FB

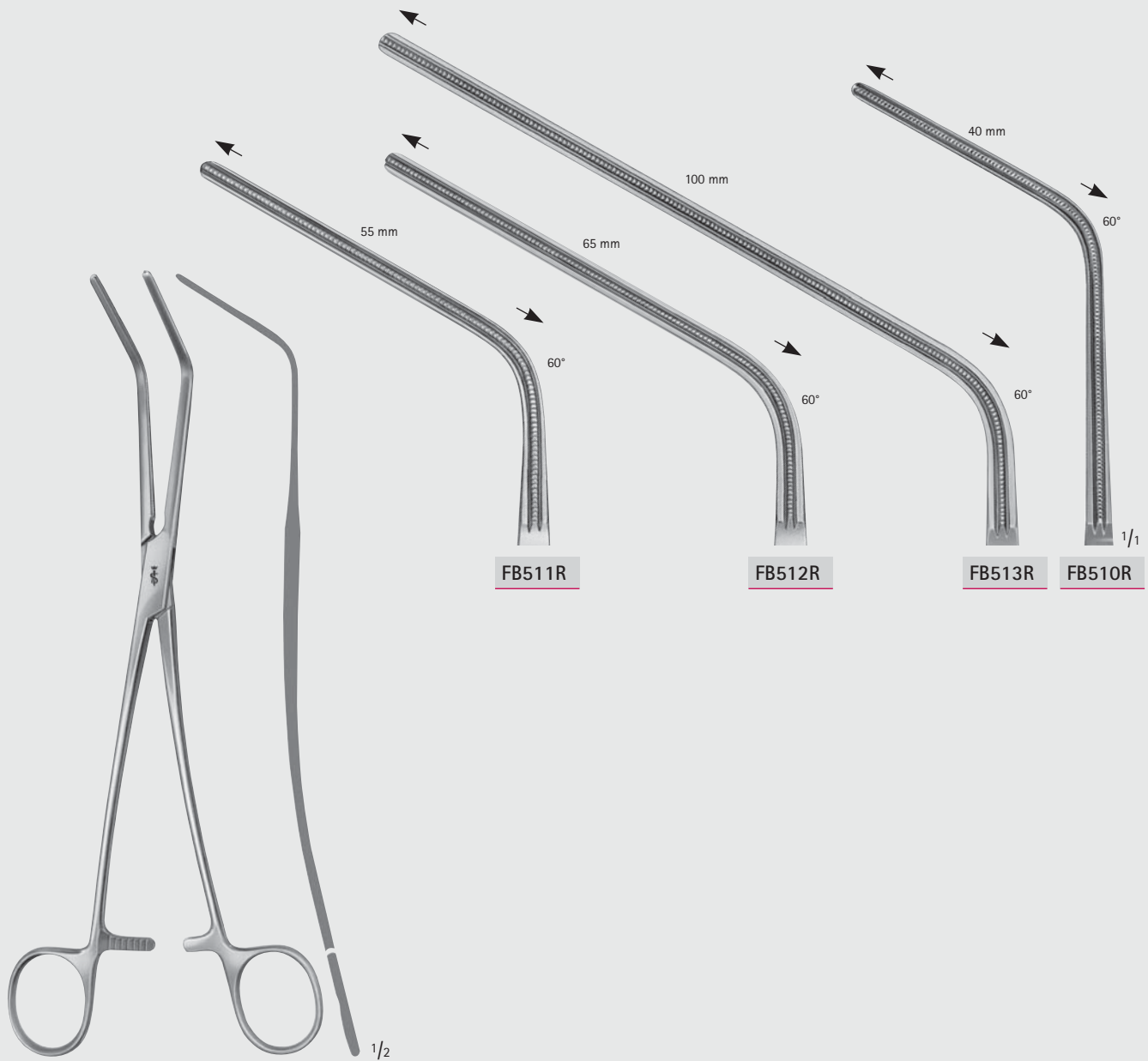

DE BAKEY

	FB511R	FB512R	FB513R	FB510R
Gesamtlänge:	230 mm	280 mm	305 mm	240 mm
Total Length:	9"	11"	12"	9 1/2"
Mauillänge:	85 mm	100 mm	135 mm	93 mm
Jaw length:	3 3/8"	4"	5 1/8"	3 3/4"

MILLIMETERS

# Herz- und Gefäß-Chirurgie – Cardiovascular Surgery

Mehrweckklemmen  
Multi-Purpose-Clamps

DE BAKEY Zahnung



Toothing DE BAKEY

AIRAUMATA®

FB

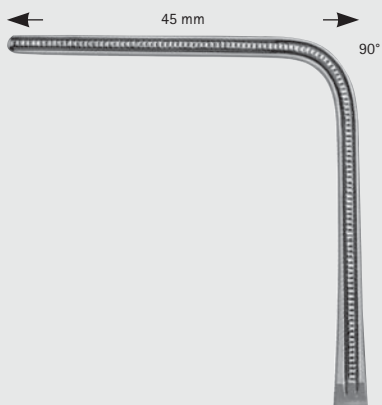

FB515R

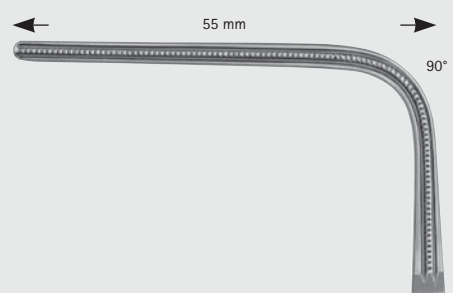

FB516R

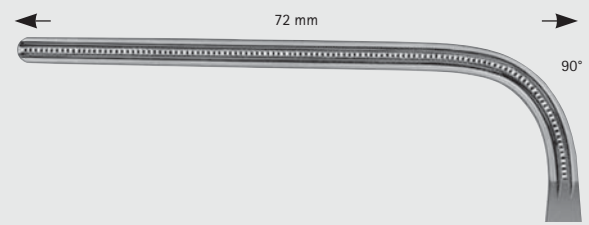

FB517R

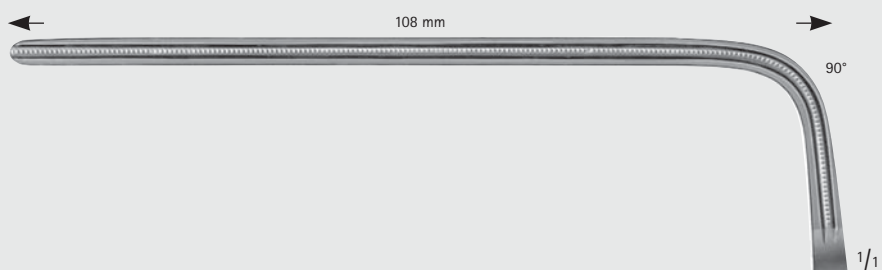

FB518R

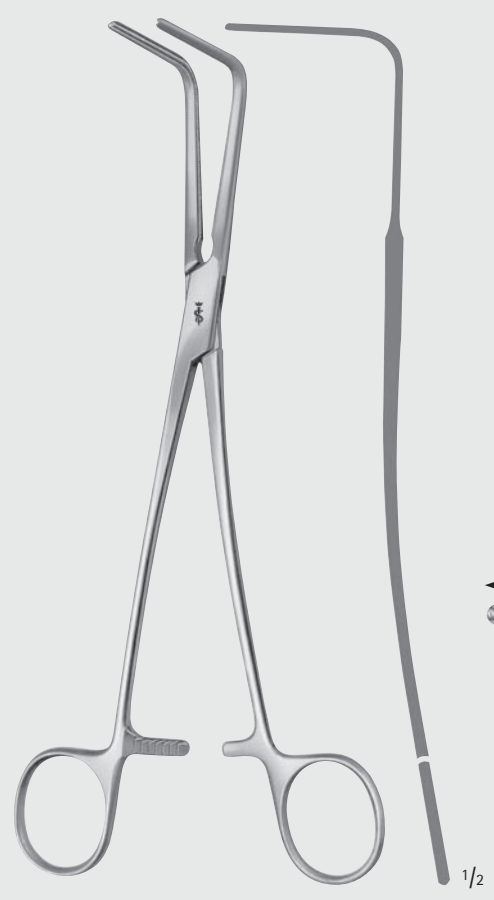

DE BAKEY

	FB515R	FB516R	FB517R	FB518R
Gesamtlänge:	225 mm	210 mm	255 mm	275 mm
Total Length:	9"	8 1/4"	10"	10 3/4"
Maullänge:	93 mm	85 mm	92 mm	134 mm
Jaw length:	3 3/4"	3 3/8"	3 5/8"	5 1/4"





DE BAKEY Zahnung



Toothing DE BAKEY

AIRAUMATA®

# Herz- und Gefäß-Chirurgie – Cardiovascular Surgery

## Aortaklemmen

### Ascending Aorta Cross Clamps

FB

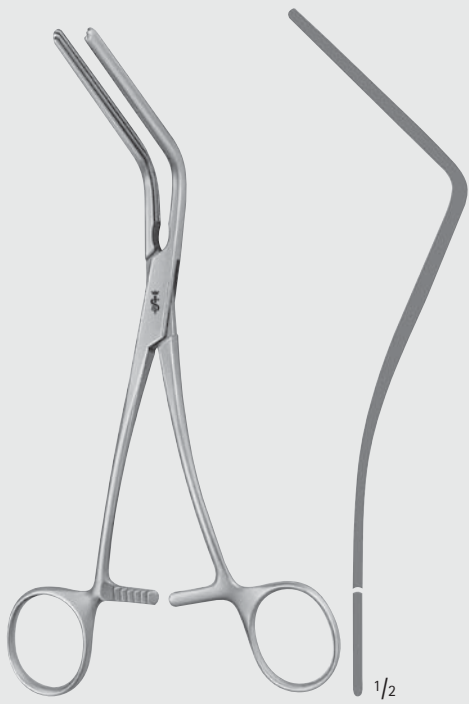
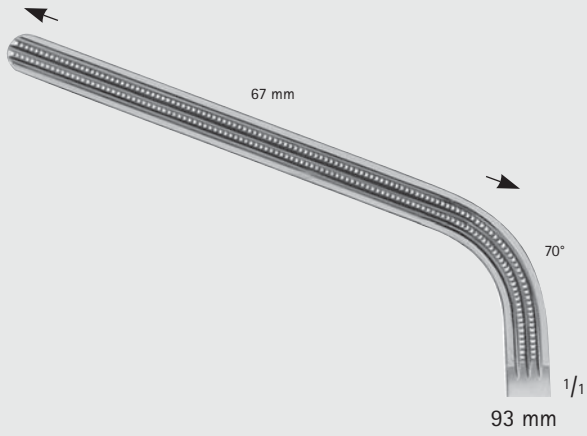

MORRIS

FB493R

175 mm, 7"

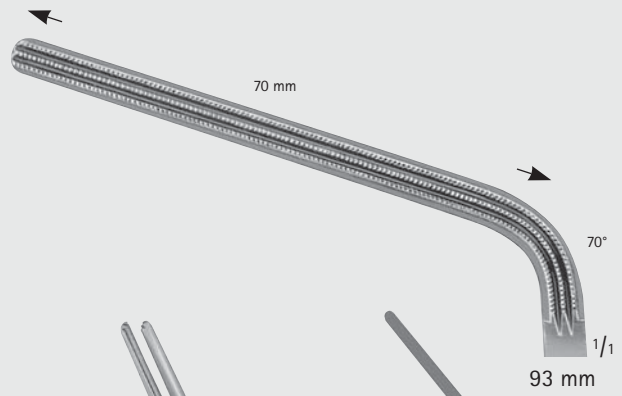

DE BAKY (MORRIS MODIF.)

FB494R

240 mm, 9"

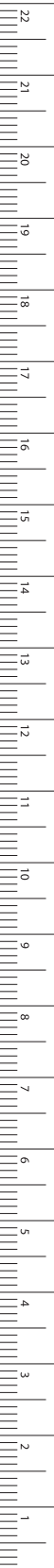

MILLIMETERS



DE BAKEY Zahnung



Toothing DE BAKEY

ARAUMATA®

# Herz- und Gefäß-Chirurgie – Cardiovascular Surgery

## Aorta-Aneurysma-Klemmen

## Aorta-Aneurysm-Clamps

FB

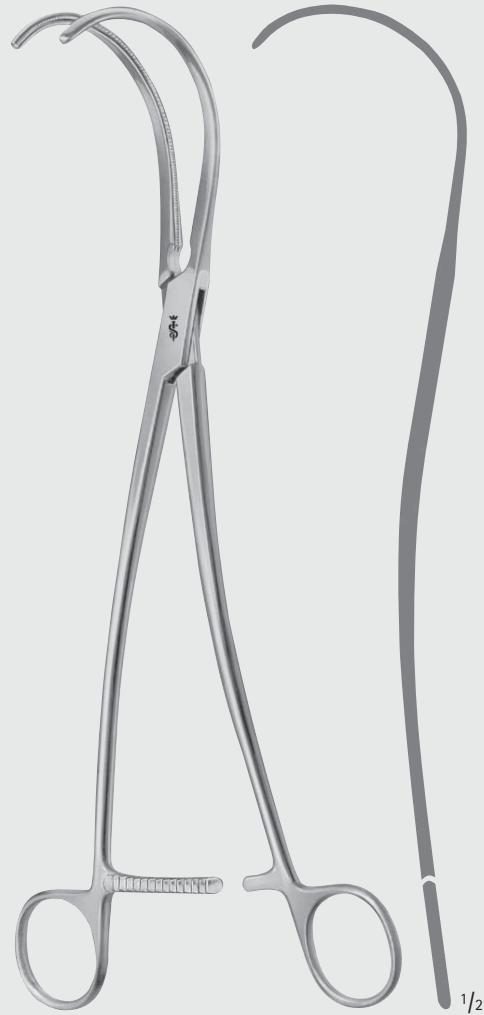
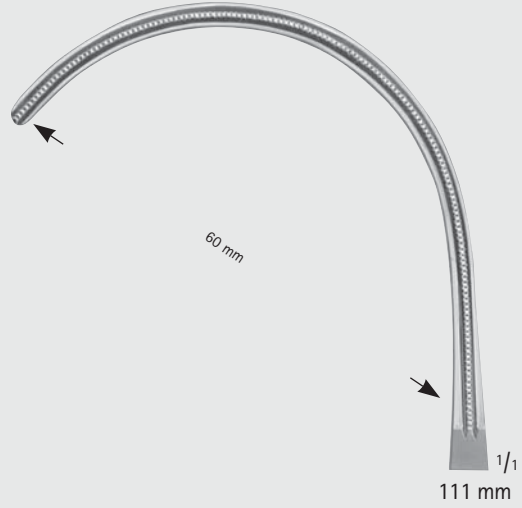
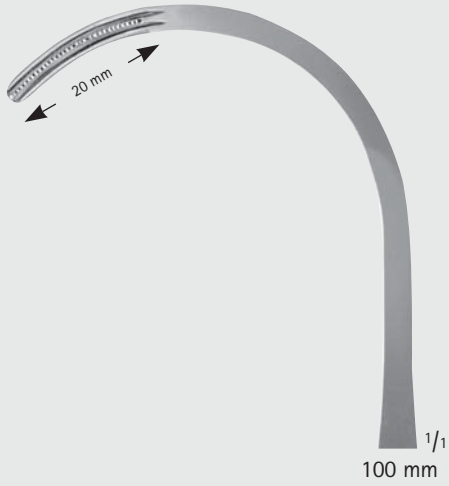

DE BAKEY (SEMB MODIF.)

FB482R

265 mm, 10 1/2"

DE BAKEY

FB481R

270 mm, 10 3/4"



# Herz- und Gefäß-Chirurgie – Cardiovascular Surgery

Aorta-Aneurysma-Klemmen

Aorta-Aneurysm-Clamps

DE BAKEY Zahnung



Toothing DE BAKEY

ARAUMATA®

FB

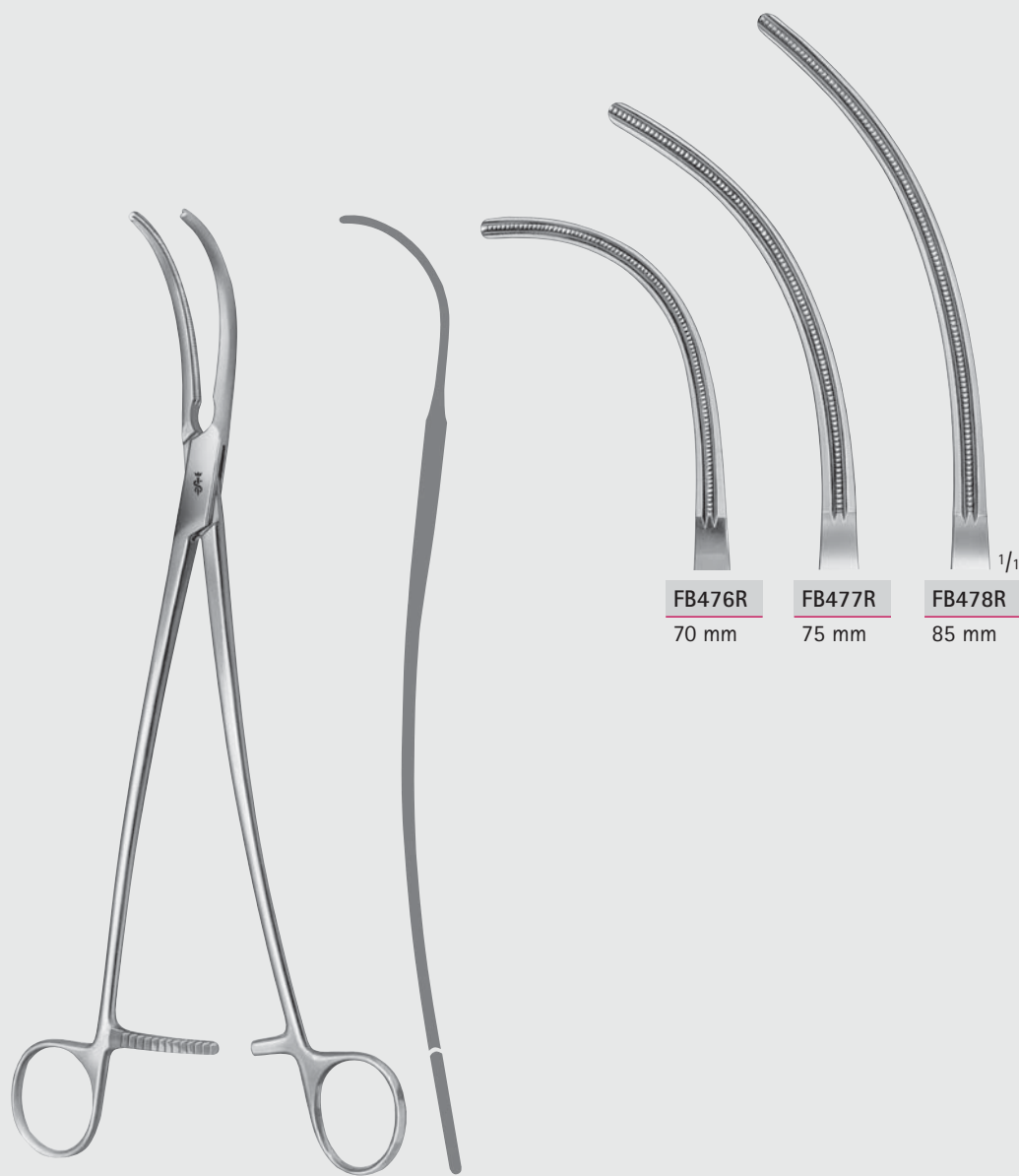

FB476R  
70 mm

FB477R  
75 mm

FB478R  
85 mm

DE BAKEY

FB476R	255 mm	10"
FB477R	265 mm	10 1/2"
FB478R	280 mm	11"

INCHES



DE BAKEY Zahnung



Toothing DE BAKEY

ARAUMATA®

# Herz- und Gefäß-Chirurgie – Cardiovascular Surgery

## Aorta-Aneurysma-Klemmen

## Aorta-Aneurysm-Clamps

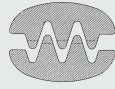

2:3 Zahnreihen  
2:3 Teeth rows

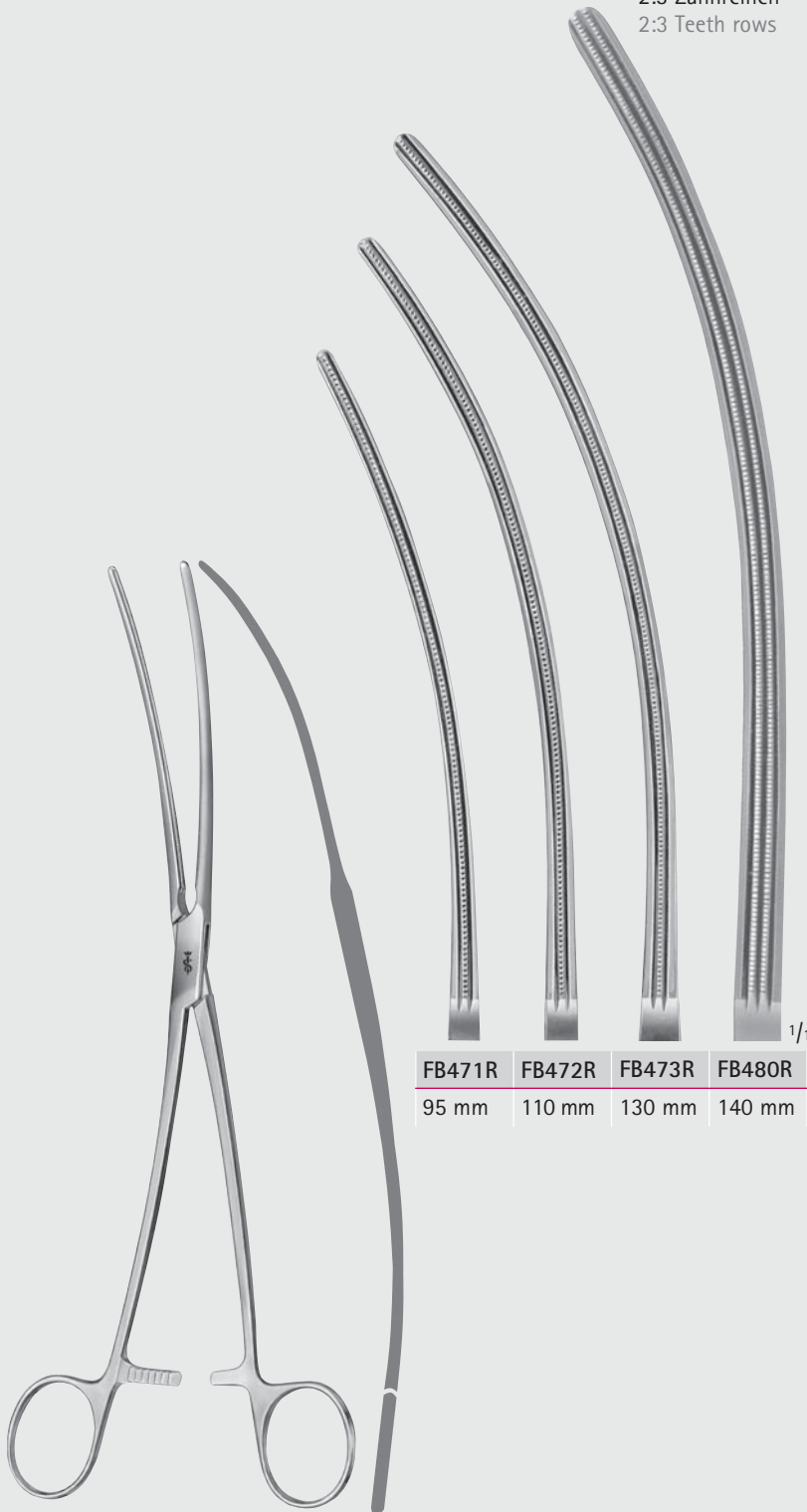

FB471R	FB472R	FB473R	FB480R
95 mm	110 mm	130 mm	140 mm

DE BAKEY

FB471R	250 mm	10"
FB472R	300 mm	12"
FB473R	315 mm	12 1/2"
FB480R	330 mm	13"

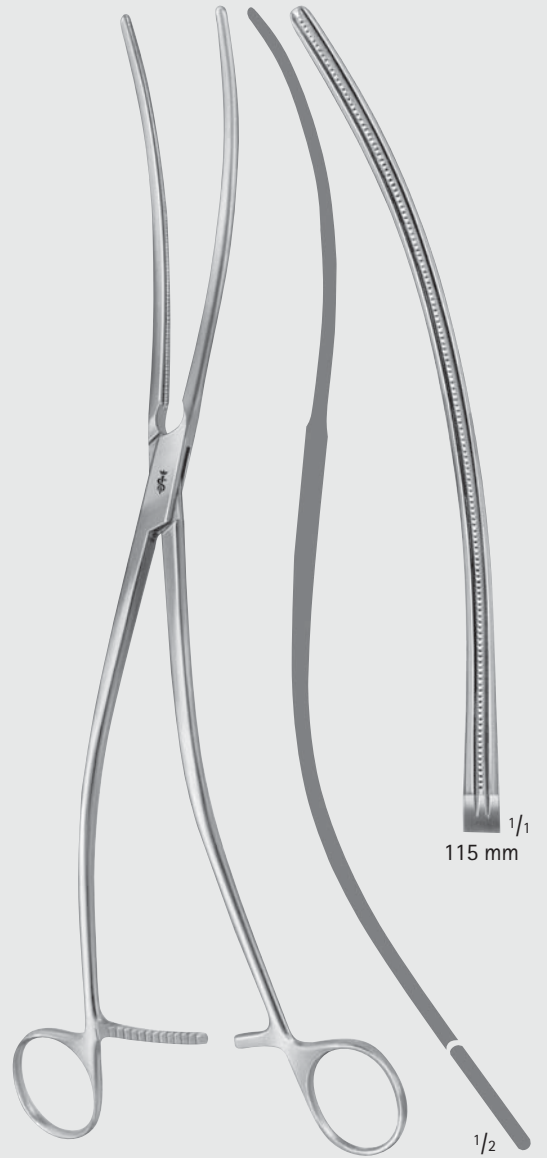

DE BAKEY

FB475R
300 mm, 12"

FB

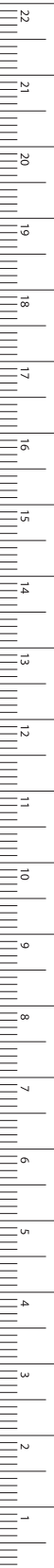

MILLIMETERS

# Herz- und Gefäß-Chirurgie – Cardiovascular Surgery

Aortaklemmen

Aorta Clamps

DE BAKEY Zahnung



Toothing DE BAKEY

ARAUMATA®

FB

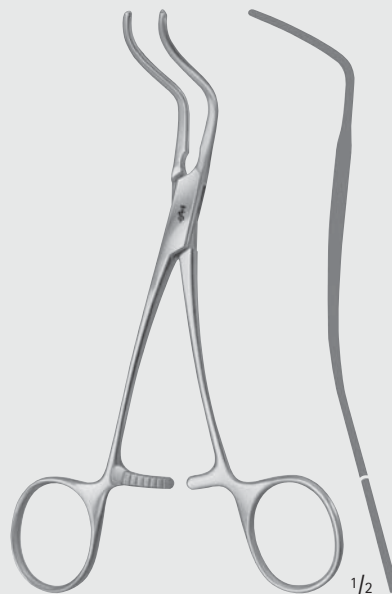
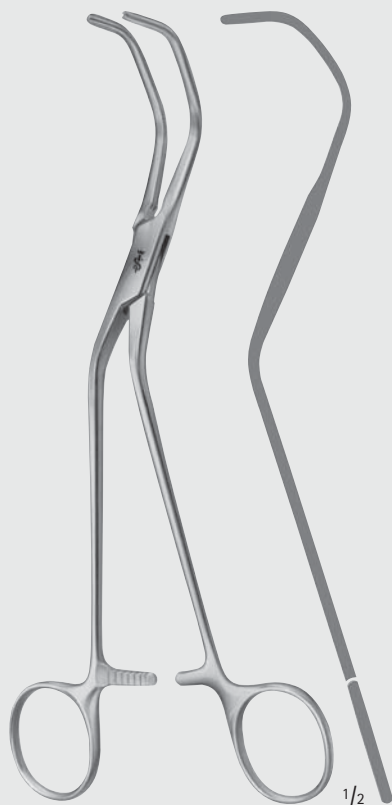
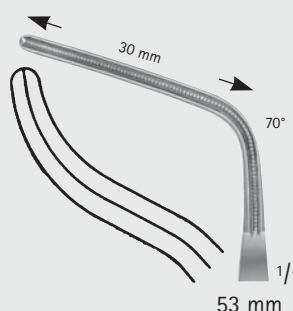
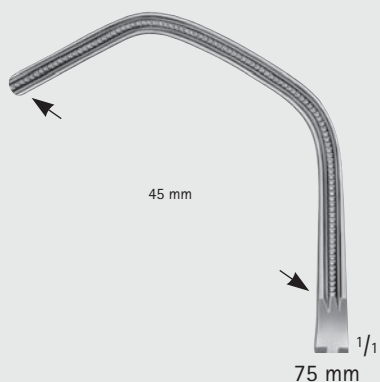

DIETRICH

FB525R

210 mm, 8 1/4"

SUBRAMANIAN (MODIF.)

FB578R

155 mm, 6"



DE BAKEY Zahnung



Toothing DE BAKEY

ARAUMATA®

# Herz- und Gefäß-Chirurgie – Cardiovascular Surgery

Aortaklemmen

Aorta Clamps

FB

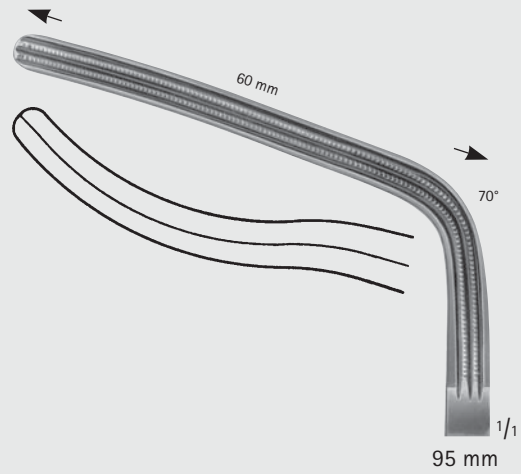
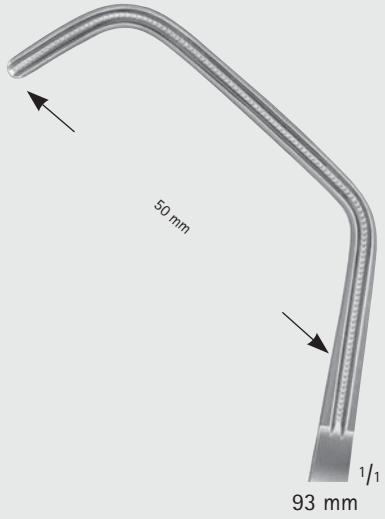

OCHSNER

FB495R

260 mm, 10 1/4"

DE BAKY

FB576R

265 mm, 10 1/2"



MILLIMETERS

# Herz- und Gefäß-Chirurgie – Cardiovascular Surgery

## Aorta-Anastomosenklemmen

### Aorta-Anastomosis Clamps

DE BAKEY Zahnung



Toothing DE BAKEY

ARAUMATA®

FB

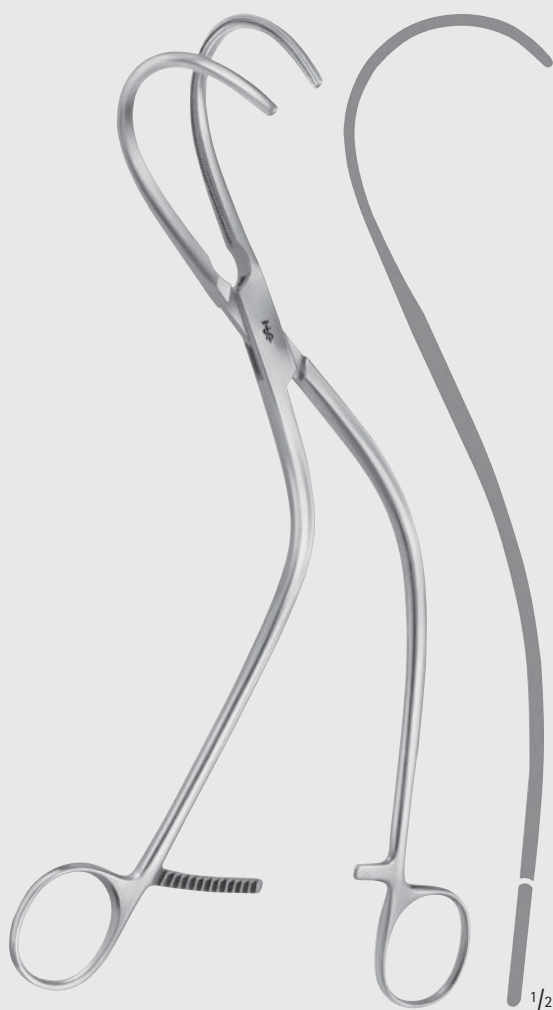
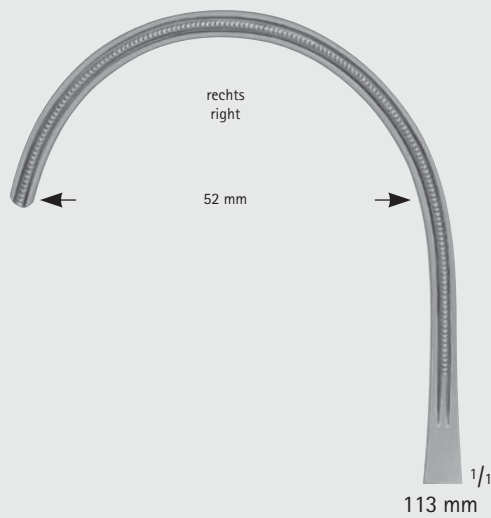
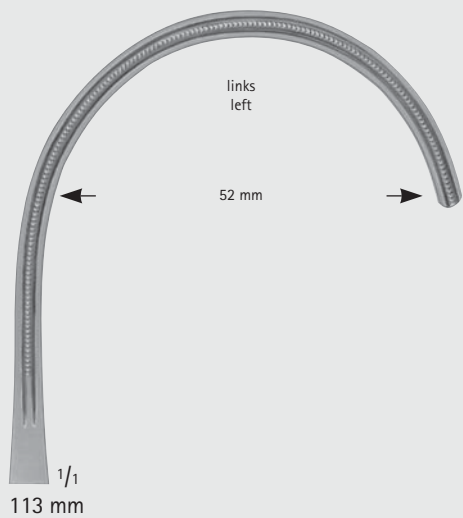

WEBER

FB488R

260 mm, 10 1/4"

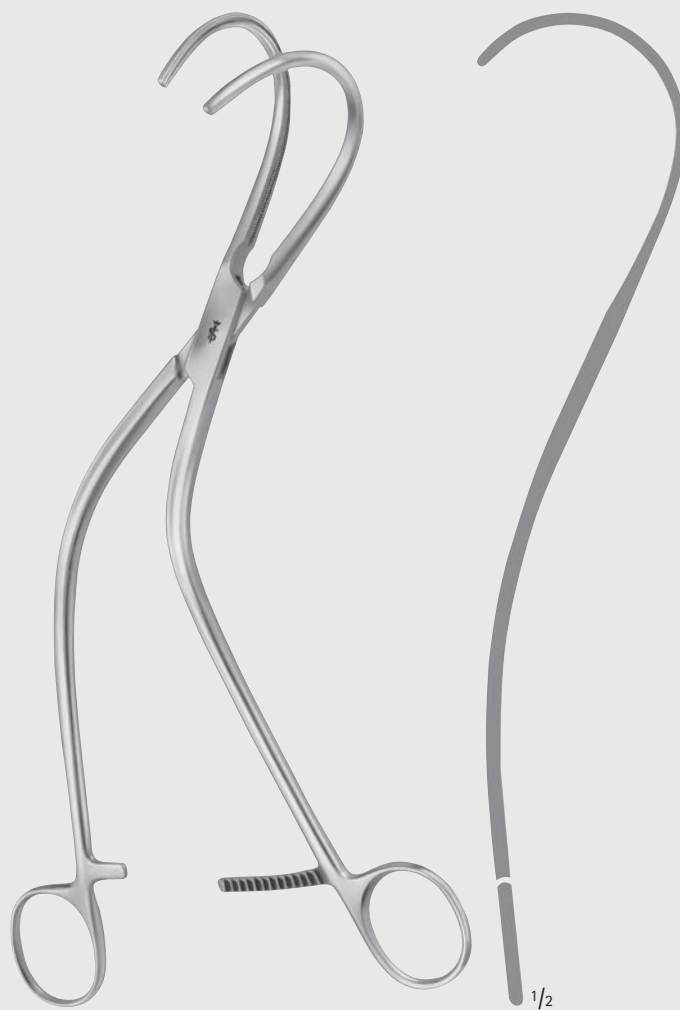

WEBER

FB489R

260 mm, 10 1/4"



DE BAKEY Zahnung



Toothing DE BAKEY

ARAUMATA®

# Herz- und Gefäß-Chirurgie – Cardiovascular Surgery

## Aorta-Anastomosenklemmen

## Aorta-Anastomosis Clamps

FB

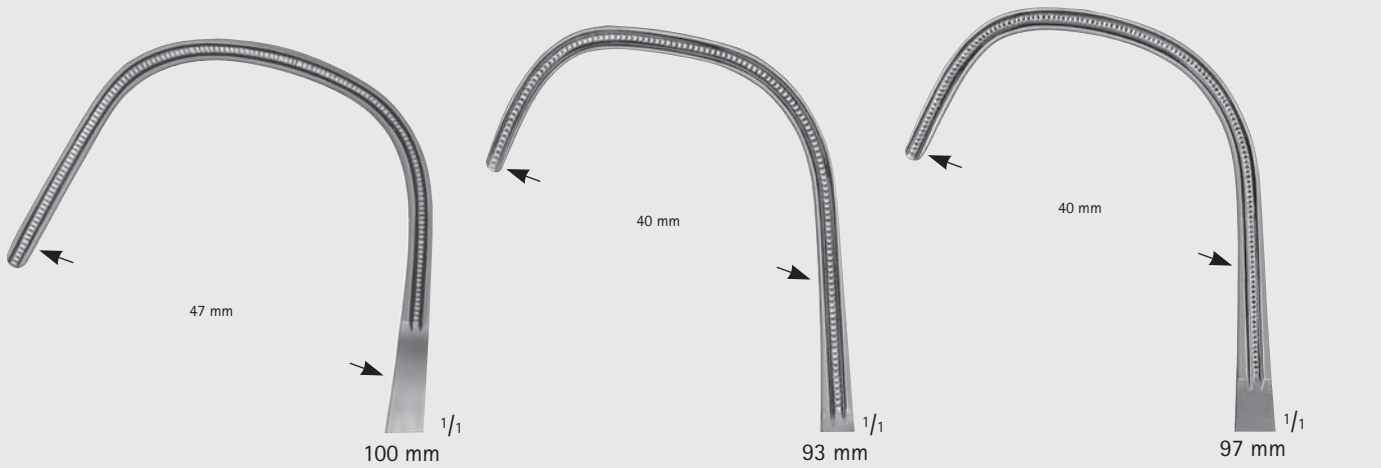

LAMBERT-KAY

FB492R

210 mm, 8 1/4"



LAMBERT-KAY

FB490R

215 mm, 8 1/2"

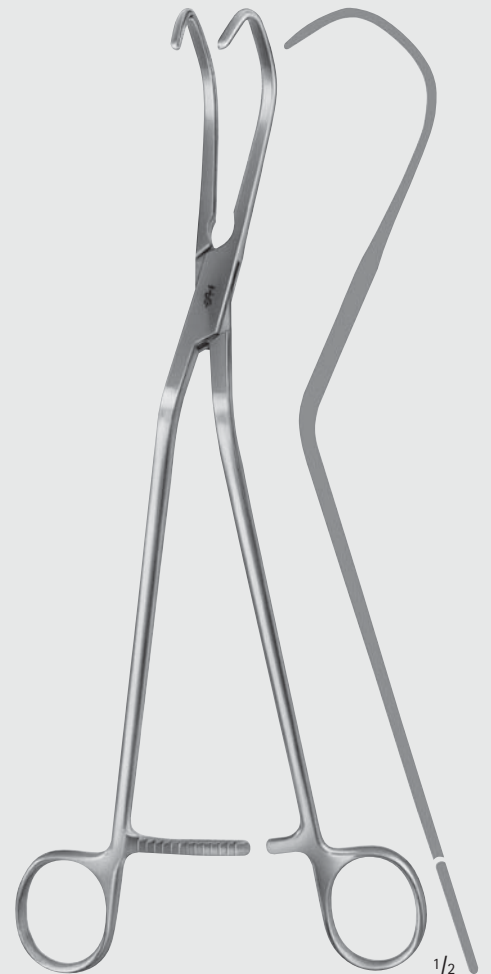

DE BAKEY (MOD. LAMBERT)

FB491R

255 mm, 10"



MILLIMETERS



# Herz- und Gefäß-Chirurgie – Cardiovascular Surgery

Bulldogklemmen mit Ringgriffen

Ring Handle Bulldog Clamps

COOLEY Zahnung



Toothing COOLEY

ARAUMATA®

FB

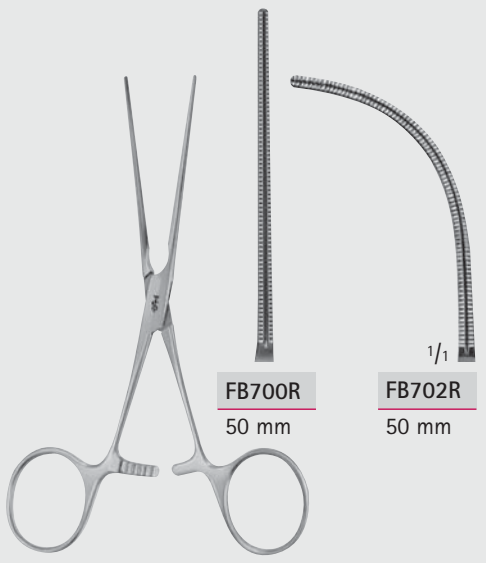

**FB700R**  
50 mm

**FB702R**  
50 mm

COOLEY

<b>FB700R</b>	125 mm	5"
<b>FB702R</b>	115 mm	4 1/2"

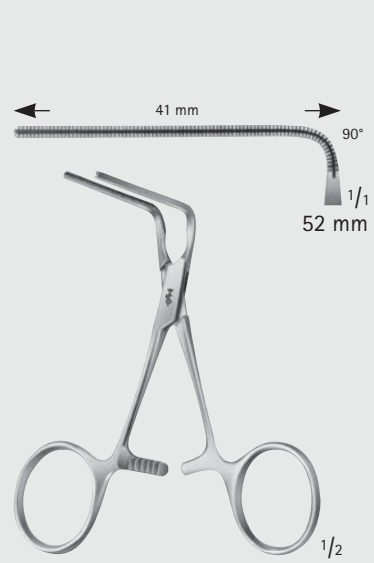

COOLEY

**FB707R**  
100 mm, 4"

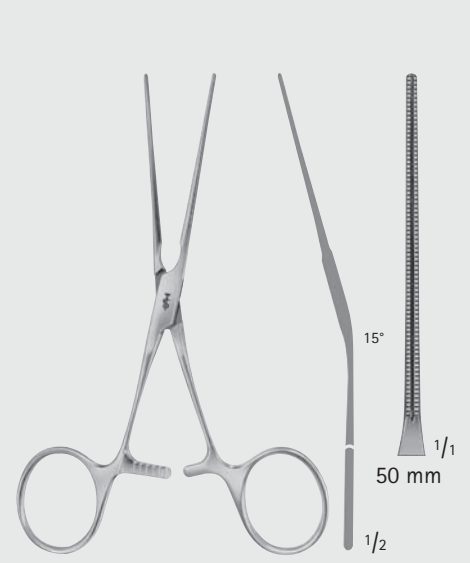

COOLEY

**FB701R**  
125 mm, 5"

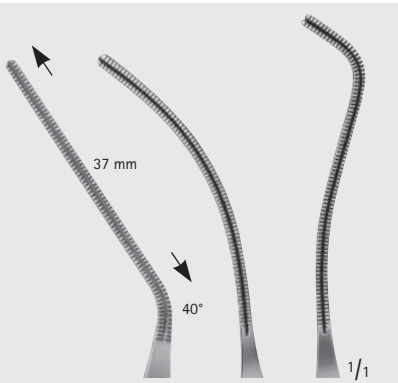

**FB704R**  
50 mm

**FB703R**  
50 mm

**FB706R**  
52 mm

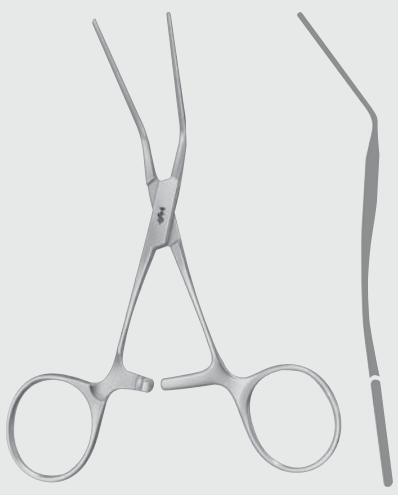

COOLEY

<b>FB704R</b>	120 mm	4 3/4"
<b>FB703R</b>	125 mm	5"
<b>FB706R</b>	125 mm	5"

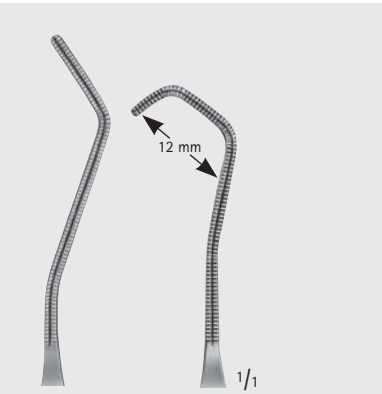

**FB705R**  
50 mm

**FB708R**  
50 mm

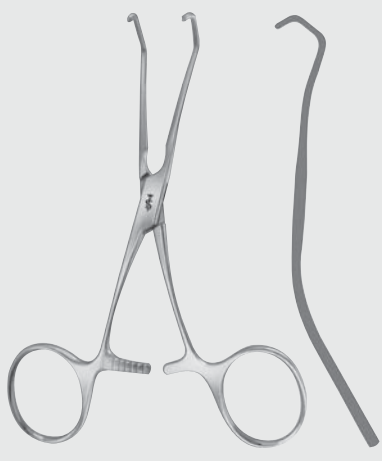

COOLEY

<b>FB705R</b>	120 mm	4 3/4"
<b>FB708R</b>	115 mm	4 1/2"



COOLEY Zahnung



ARAUMATA®

# Herz- und Gefäß-Chirurgie – Cardiovascular Surgery

## Bulldogklemmen mit Ringgriffen

### Ring Handle Bulldog Clamps

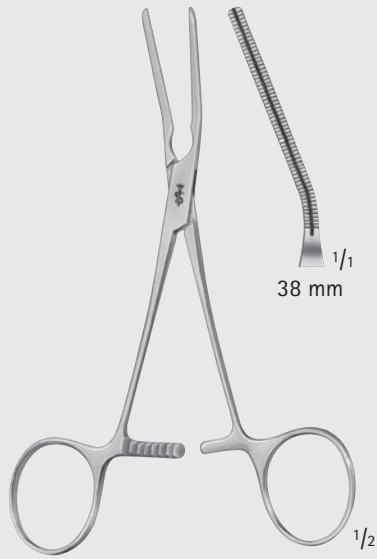

COOLEY

**FB741R**

145 mm, 5 3/4"



COOLEY

**FB742R**

140 mm, 5 1/2"

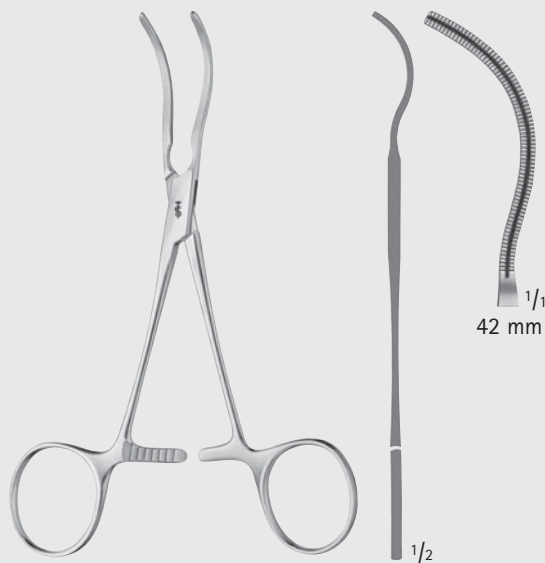

COOLEY

**FB743R**

145 mm, 5 3/4"

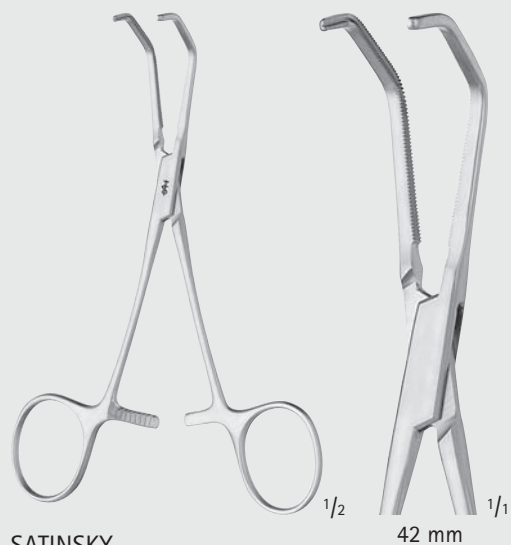

SATINSKY

**MB613R**

140 mm, 5 1/2"

FB

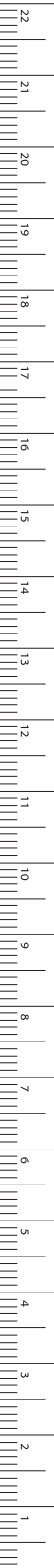

MILLIMETERS

# Herz- und Gefäß-Chirurgie – Cardiovascular Surgery

Anastomosenklemmen, Kinder-Modelle

Anastomosis Clamps, Pediatric Patterns

COOLEY Zahnung



Toothing COOLEY

ARAUMATA®

FB

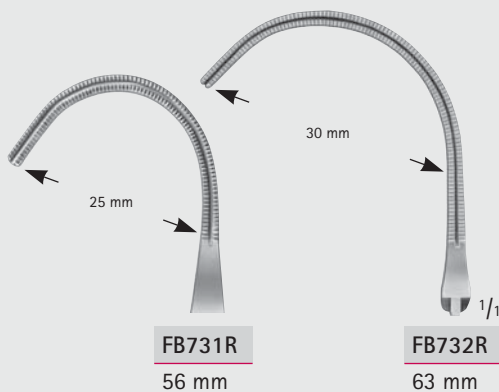

COOLEY-BECK

FB731R	150 mm	6"
FB732R	155 mm	6"

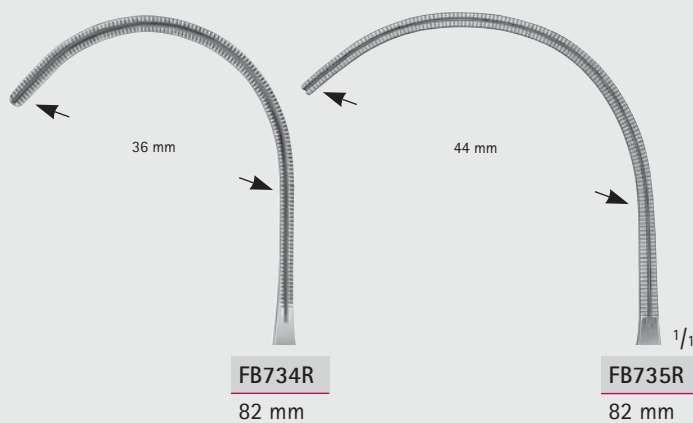

COOLEY

FB734R-FB735R	170 mm, 6 3/4"
---------------	----------------

INCHES



COOLEY Zahnung



Toothing COOLEY

ARAUMATA®

# Herz- und Gefäß-Chirurgie – Cardiovascular Surgery

Anastomosenklemmen, Kinder-Modelle

Anastomosis Clamps, Pediatric Patterns

FB

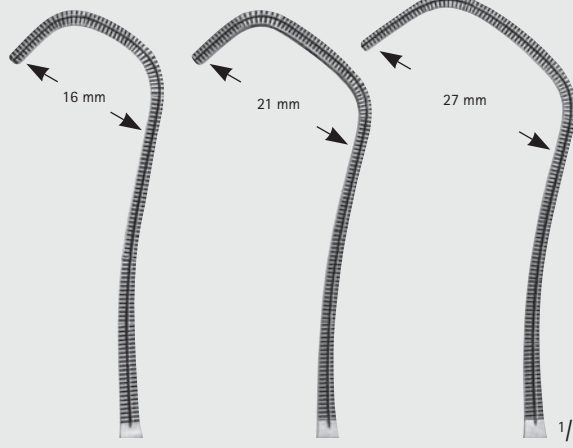

FB725R  
71 mm

FB726R  
76 mm

FB727R  
80 mm

## DERRA-COOLEY

FB725R	170 mm	6 3/4"
FB726R	175 mm	7"
FB727R	175 mm	7"

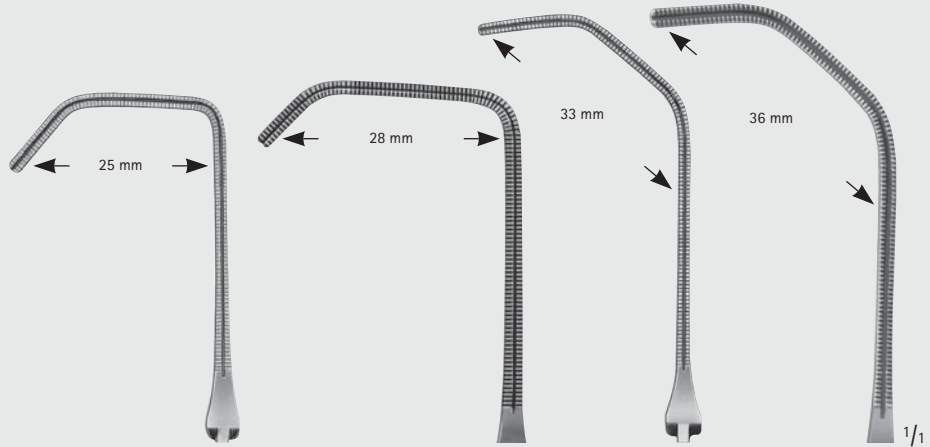

FB721R  
72 mm

FB722R  
76 mm

FB723R  
72 mm

FB724R  
76 mm

## COOLEY

FB721R	165 mm	6 1/2"
FB722R	165 mm	6 1/2"
FB723R	175 mm	7"
FB724R	180 mm	7"

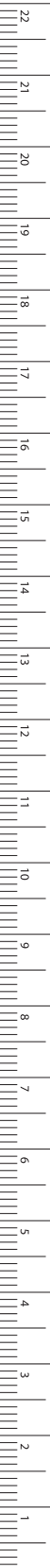

MILLIMETERS

# Herz- und Gefäß-Chirurgie – Cardiovascular Surgery

Mehrzweckklemmen, Kinder-Modelle

Multi-Purpose Clamps, Pediatric Patterns

COOLEY Zahnung



Toothing COOLEY

APRAUMATA®

FB

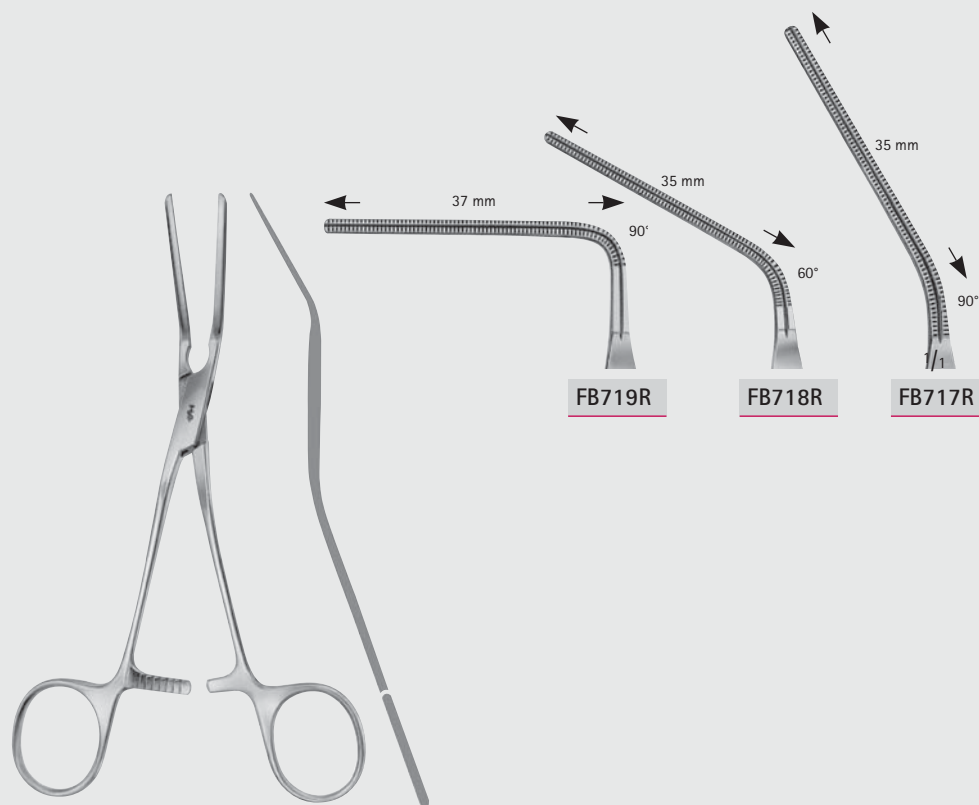

COOLEY

FB719R	150 mm	6"
FB718R	160 mm	6 1/4"
FB717R	165 mm	6 1/2"

INCHES



COOLEY Zahnung



ARAUMATA®

# Herz- und Gefäß-Chirurgie – Cardiovascular Surgery

Anastomosenklemmen, Mehrzweckklemmen  
Anastomosis Clamps, Multi-Purpose Clamps

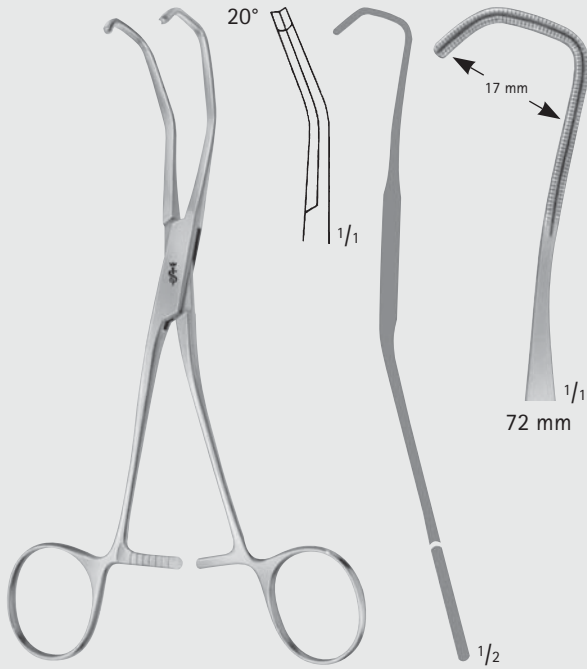

COOLEY

**FB729R**

170 mm, 6 3/4"

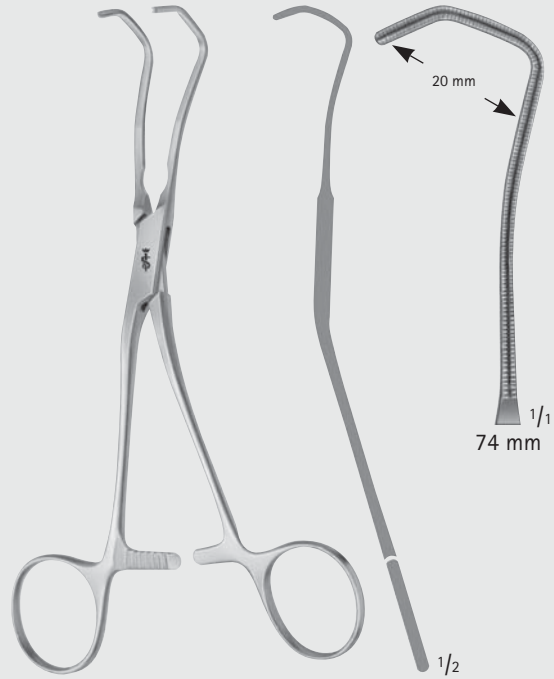

COOLEY

**FB730R**

175 mm, 7"

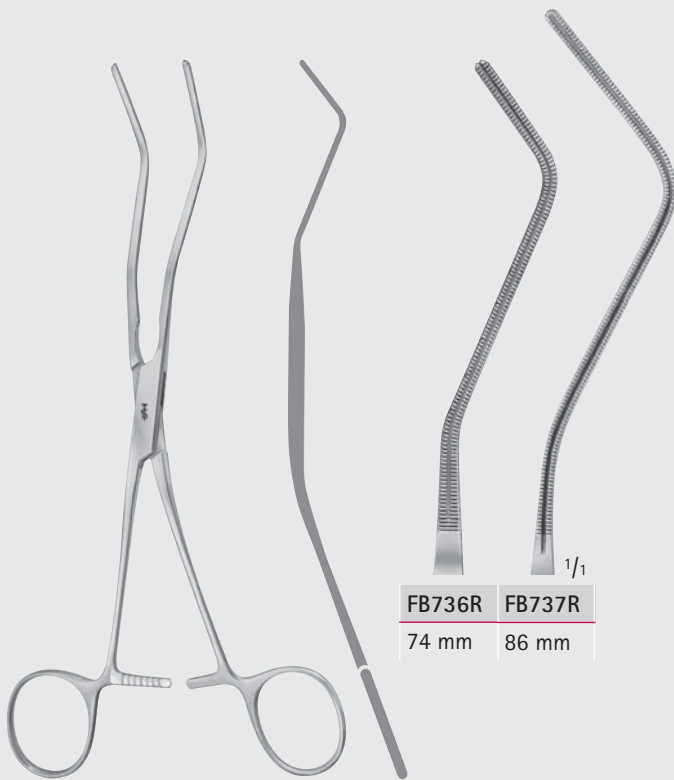

COOLEY

<b>FB737R</b>	195 mm	7 3/4"
<b>FB736R</b>	185 mm	7 1/4"

FB

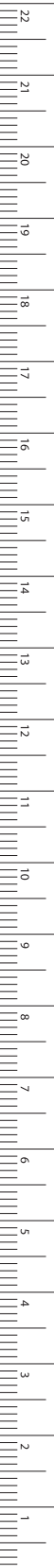

MILLIMETERS

# Herz- und Gefäß-Chirurgie – Cardiovascular Surgery

Patent-Ductusklemmen, Coarctationsklemmen, Kinder-Modelle

Patent-Ductus Clamps, Coarctations Clamps, Pediatric Patterns

**APRAUMATA®**

COOLEY Zahnung



Toothing COOLEY

**FB**

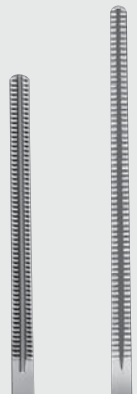

<b>FB710R</b>	<b>FB712R</b>
41 mm	52 mm



<b>FB713R</b>	<b>FB715R</b>
52 mm	63 mm

COOLEY

<b>FB710R</b>	160 mm	6 1/4"
<b>FB712R</b>	170 mm	6 3/4"
<b>FB713R</b>	180 mm	7"
<b>FB715R</b>	180 mm	7"

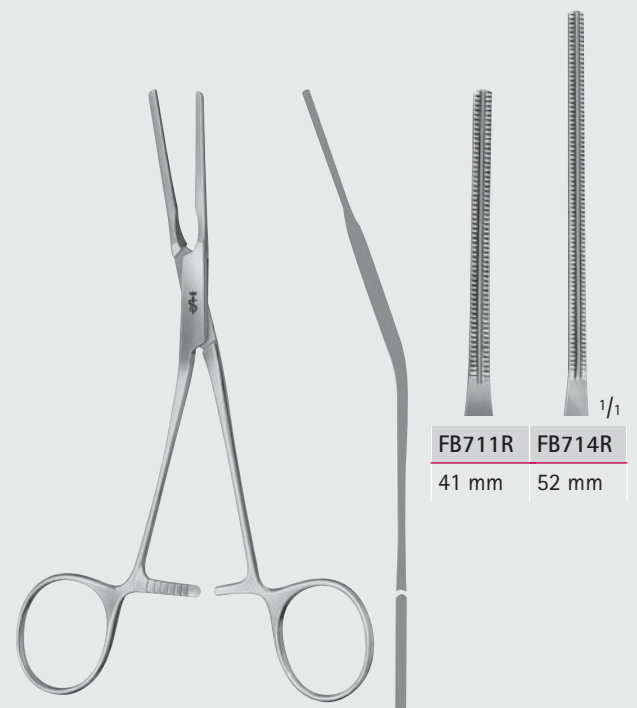

<b>FB711R</b>	<b>FB714R</b>
41 mm	52 mm

COOLEY

<b>FB711R</b>	160 mm	6 1/4"
<b>FB714R</b>	170 mm	6 3/4"



COOLEY Zahnung



Toothing COOLEY

**ARAUMATA**®

## Herz- und Gefäß-Chirurgie – Cardiovascular Surgery

Patent-Ductusklemmen, Coarctationsklemmen, Kinder-Modelle  
Patent-Ductus Clamps, Coarctations Clamps, Pediatric Patterns

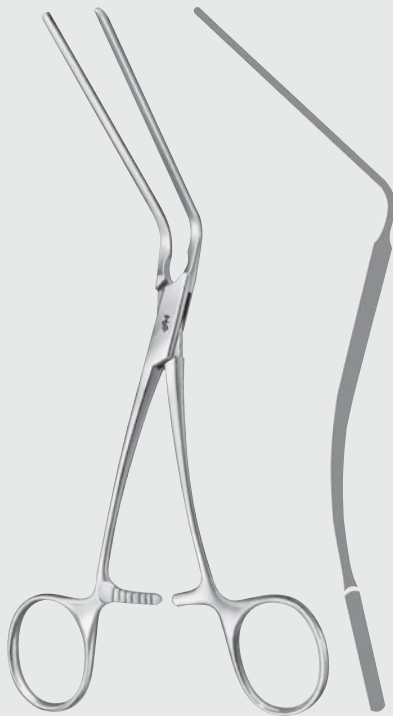
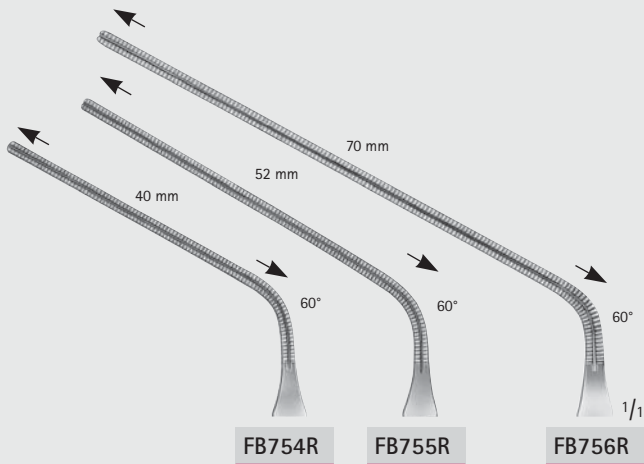

COOLEY

<b>FB754R</b>	165 mm	6 1/2"
<b>FB755R</b>	170 mm	6 3/4"
<b>FB756R</b>	185 mm	7 1/4"

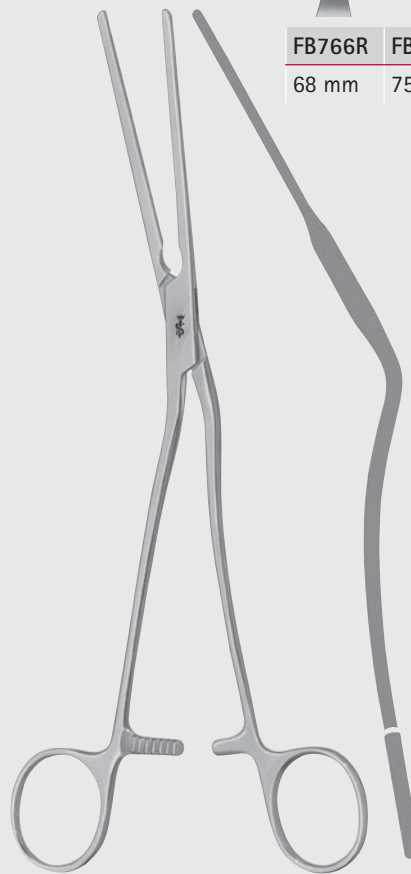
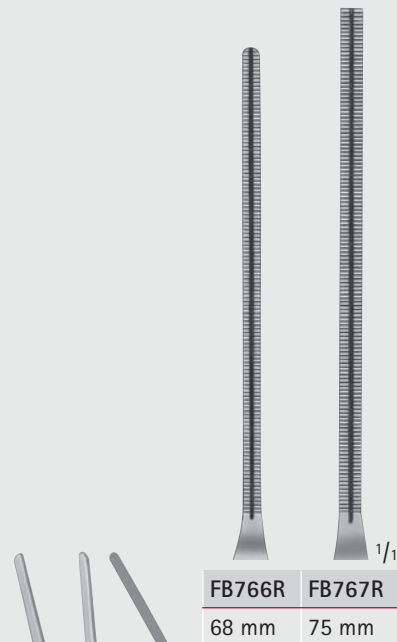

<b>FB766R</b>	225 mm	9"
<b>FB767R</b>	270 mm	10 3/4"

**FB**

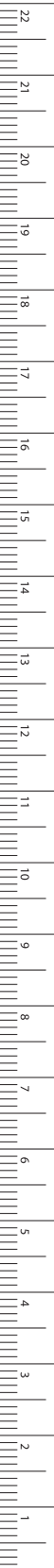



# Herz- und Gefäß-Chirurgie – Cardiovascular Surgery

Anastomosenklemmen, Mehrzweckklemmen

Anastomosis Clamps, Multi-Purpose Clamps

COOLEY Zahnung



Toothing COOLEY

APRAUMATA®

FB

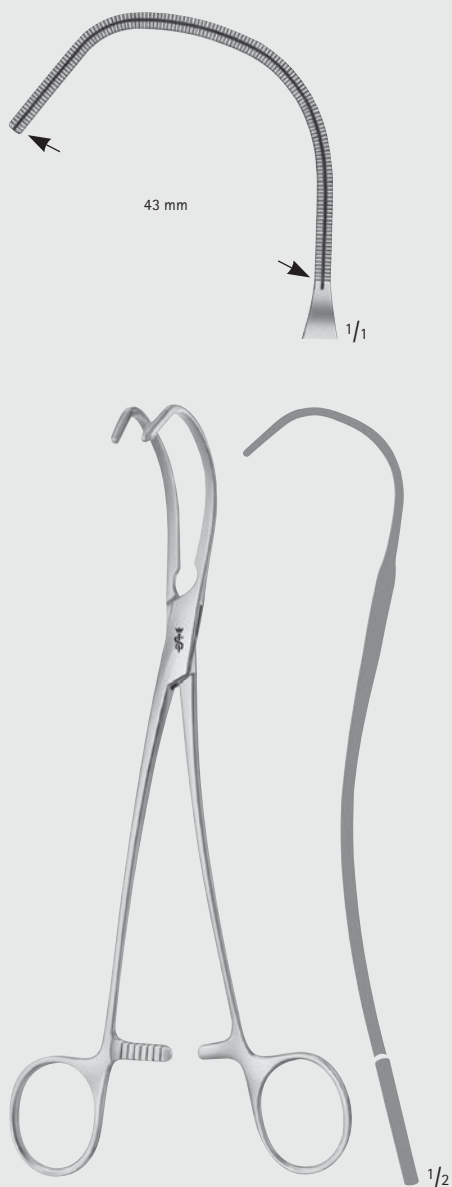

LEITZ

FB795R

205 mm, 8"

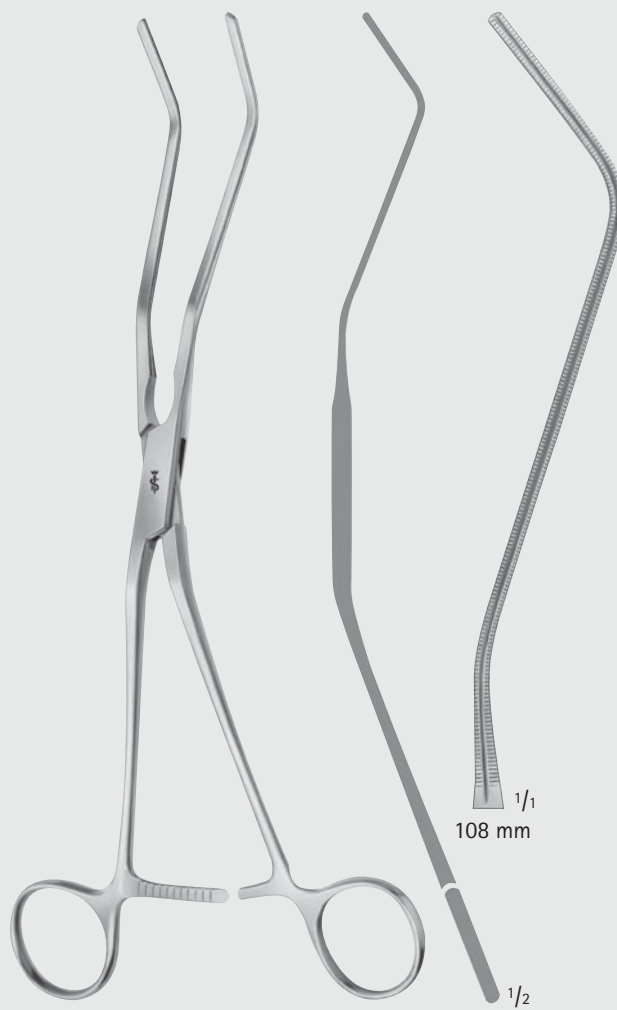

COOLEY

FB738R

260 mm, 10 3/4"



COOLEY Zahnung



ARAUMATA®

# Herz- und Gefäß-Chirurgie – Cardiovascular Surgery

Anastomosenklemmen

Anastomosis Clamps

FB

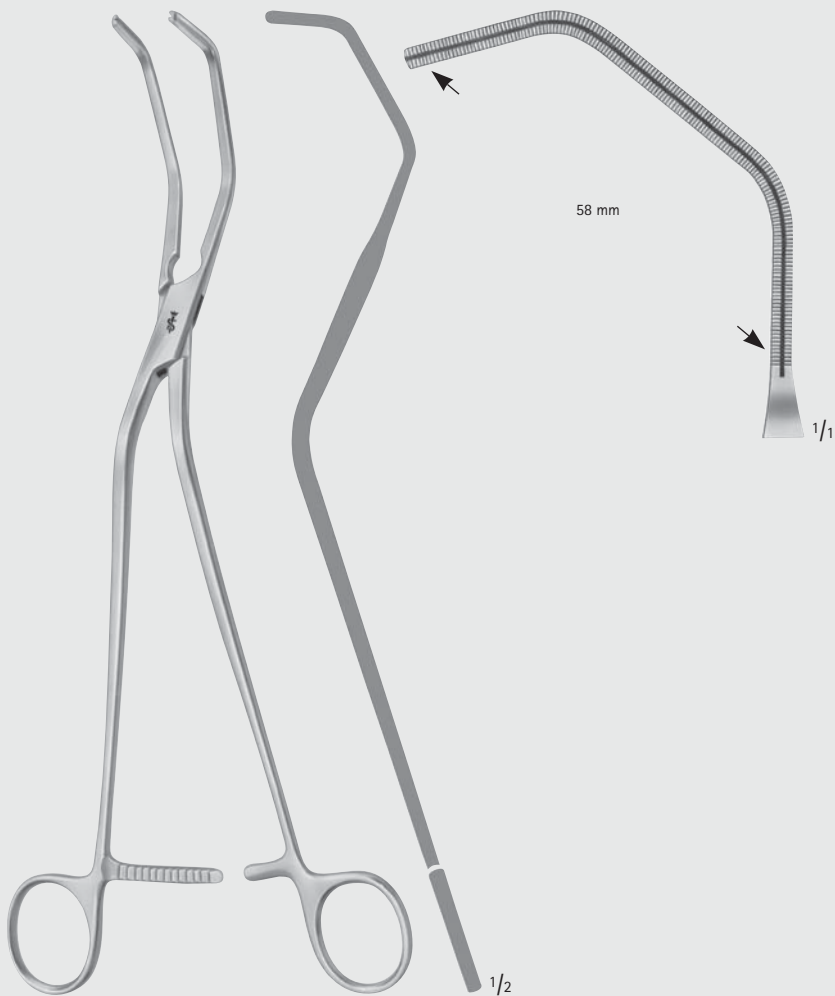

COOLEY

FB773R

260 mm, 10 1/4"



MILLIMETERS

# Herz- und Gefäß-Chirurgie – Cardiovascular Surgery

Anastomosenklemmen

Anastomosis Clamps

COOLEY Zahnung



Toothing COOLEY

APRAUMATA®

FB

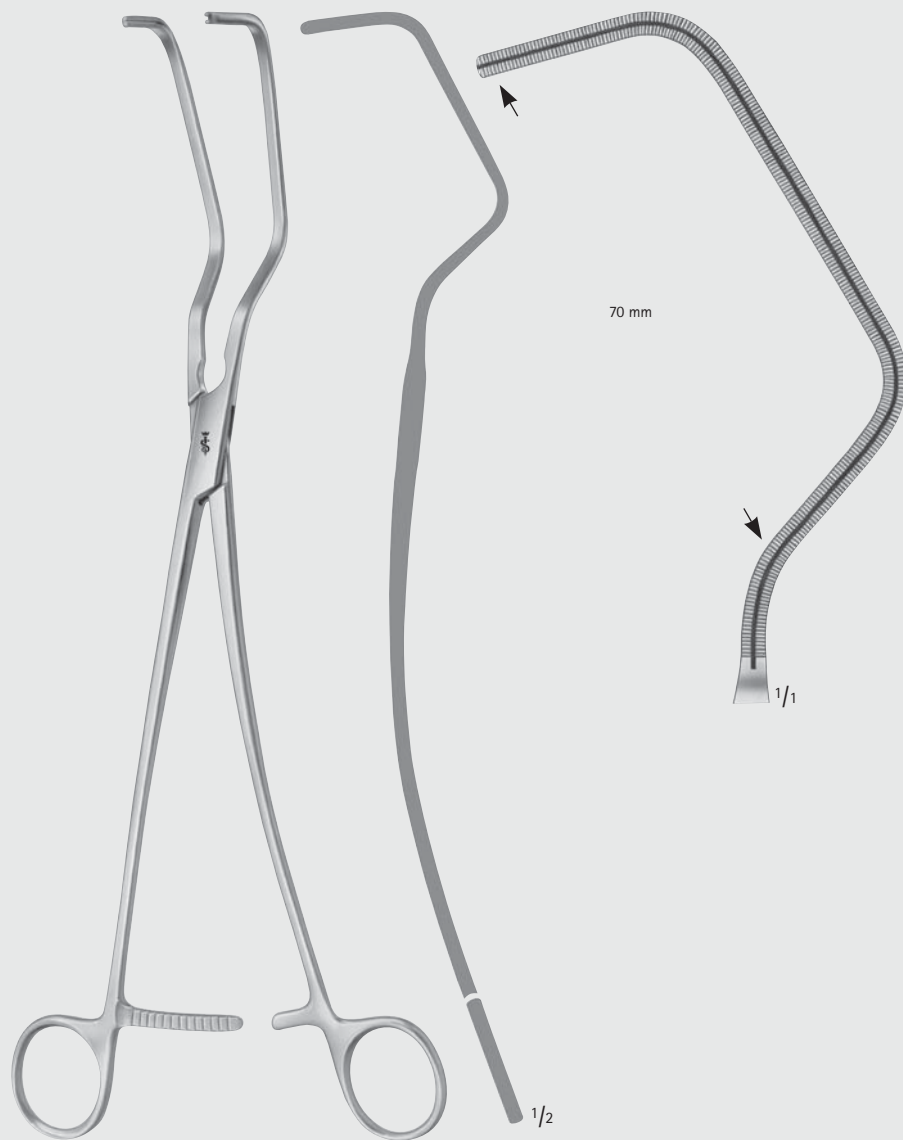

PARRY-COOLEY

FB775R

295 mm, 11 3/4"

INCHES



COOLEY Zahnung



ARAUMATA®

# Herz- und Gefäß-Chirurgie – Cardiovascular Surgery

Anastomosenklemmen

Anastomosis Clamps

FB

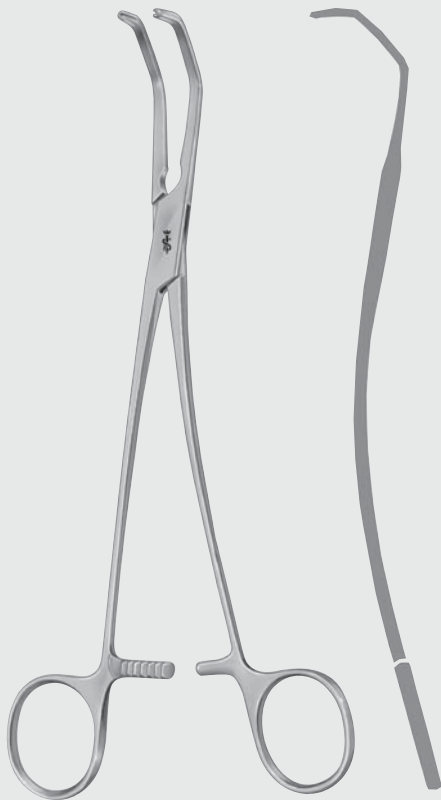
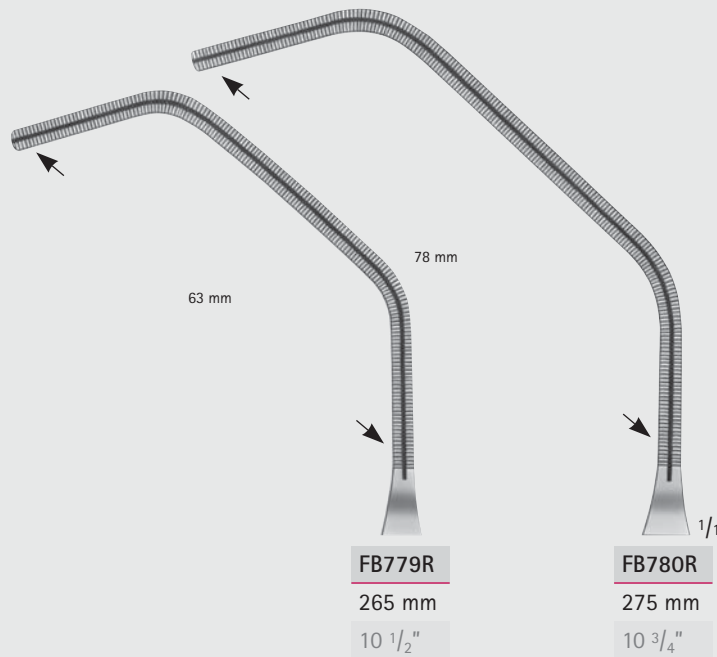

COOLEY

**FB776R-FB780R**



MILLIMETERS

Herz- und Gefäß-Chirurgie – Cardiovascular Surgery

Aortaklemme

Aorta Clamp

COOLEY Zahnung



Toothing COOLEY

APRAUMATA®

FB

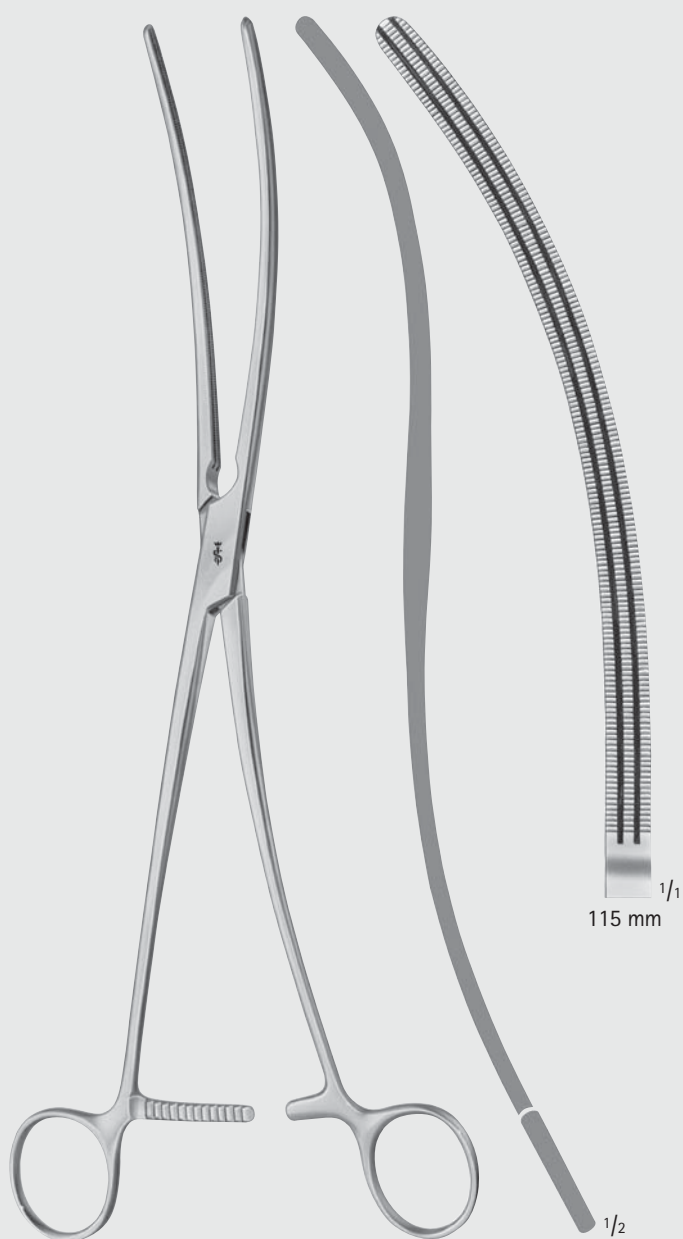

COOLEY

FB764R

320 mm, 12 3/4"



COOLEY Zahnung



Toothing COOLEY

ARAUMATA®

## Herz- und Gefäß-Chirurgie – Cardiovascular Surgery

Mehrweckklemme  
Multi-Purpose Clamp

FB



COOLEY

FB765R

285 mm, 11 1/4"



# Herz- und Gefäß-Chirurgie – Cardiovascular Surgery

Mehrzweckklemmen  
Multi-Purpose Clamps

DE BAKEY Zahnung



Toothing DE BAKEY

APRAUMATA®

FB

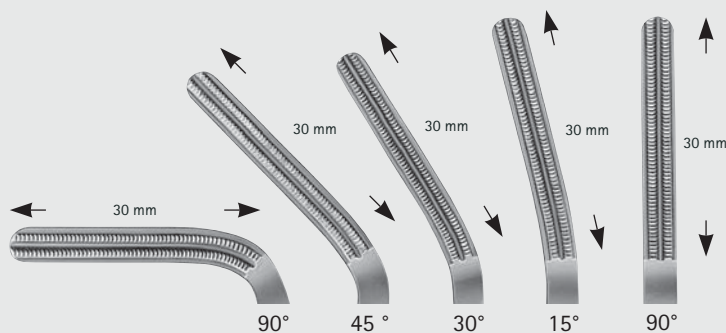

FC304R	FC303R	FC302R	FC301R	FC300R
130 mm	145 mm	150 mm	150 mm	150 mm
5 1/8"	5 3/4"	6"	6"	6"

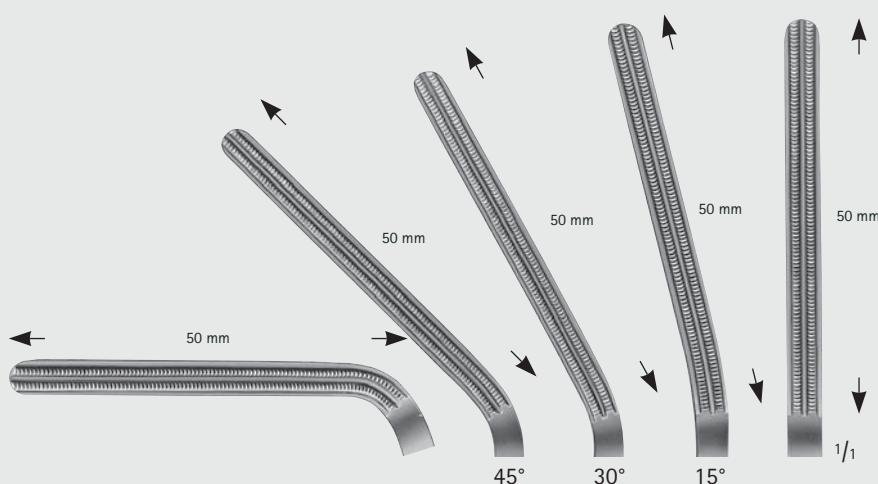

FC314R	FC313R	FC312R	FC311R	FC310R
135 mm	160 mm	170 mm	170 mm	170 mm
5 1/4"	6 1/4"	6 3/4"	6 3/4"	6 3/4"

FC300R-FC314R

INCHES



DE BAKEY Zahnung



Toothing DE BAKEY

**APRAUMATA®**

## Herz- und Gefäß-Chirurgie – Cardiovascular Surgery

Gewebe- und Organfanzangen

Tissue- and Organ Grasping Forceps

**FB**

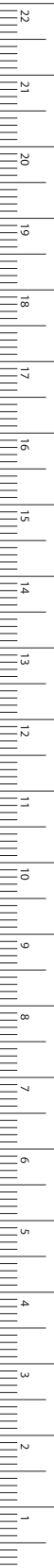

MILLIMETERS

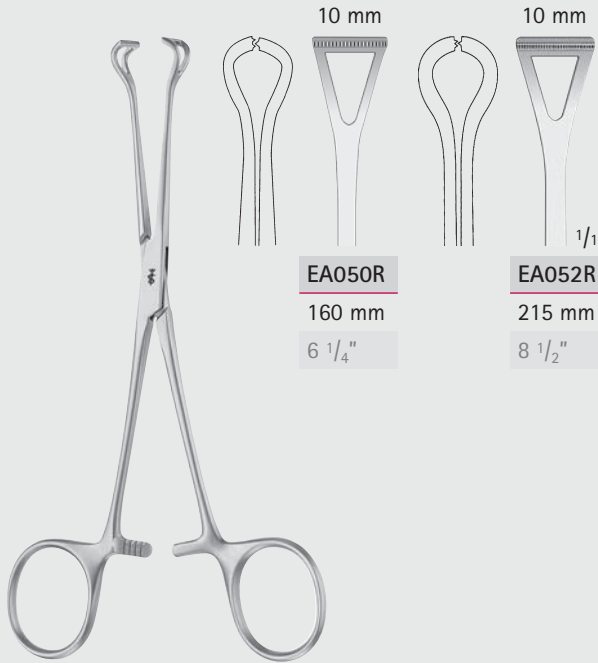

**EA050R**  
160 mm  
6 1/4"

**EA052R**  
215 mm  
8 1/2"

**BABCOCK**

**EA050R-EA052R**



**BABCOCK**

**FB936R**

220 mm, 8 3/4"



**BABCOCK**

**MD470**

240 mm, 9 1/2"



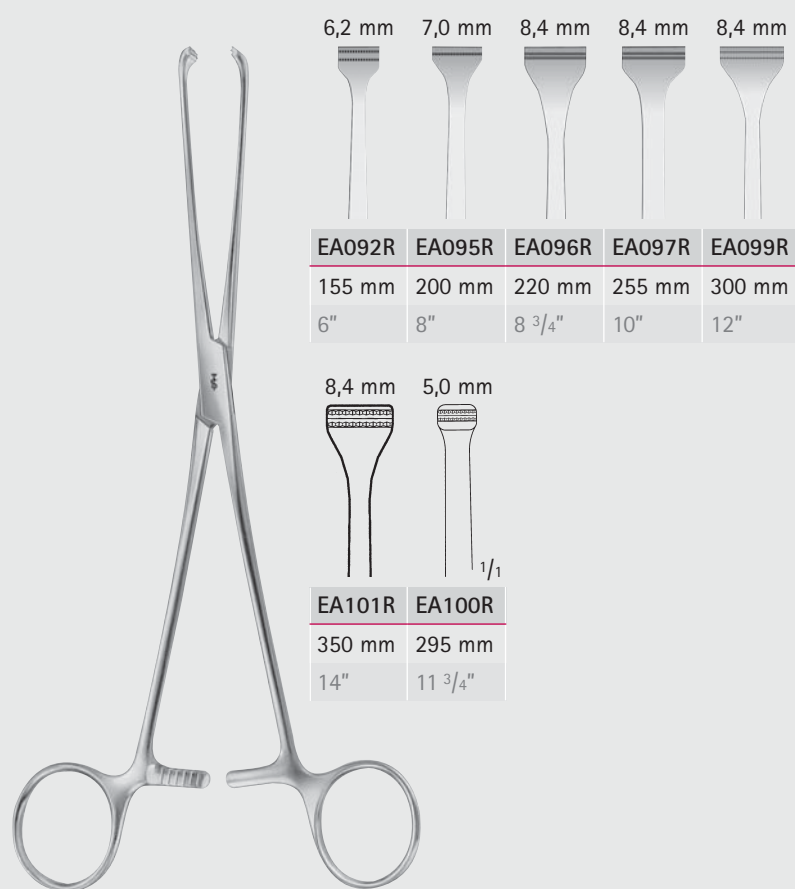

6,2 mm	7,0 mm	8,4 mm	8,4 mm	8,4 mm
<b>EA092R</b>	<b>EA095R</b>	<b>EA096R</b>	<b>EA097R</b>	<b>EA099R</b>
155 mm	200 mm	220 mm	255 mm	300 mm
6"	8"	8 3/4"	10"	12"

8,4 mm	5,0 mm
<b>EA101R</b>	<b>EA100R</b>
350 mm	295 mm
14"	11 3/4"

**ALLIS**  
**EA092R-EA101R**

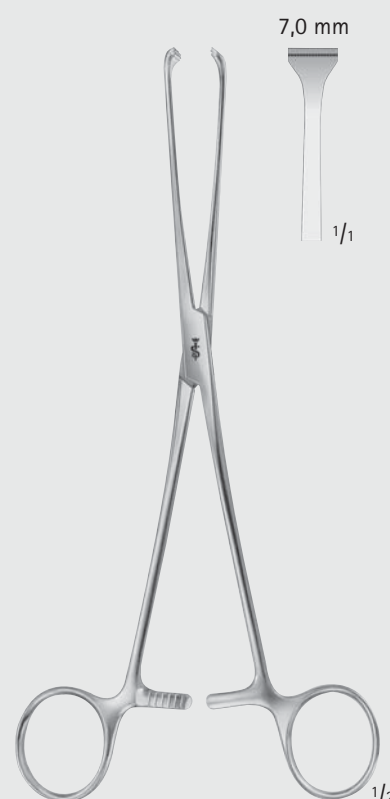

**ALLIS**  
**EA095R**

besonders fein  
 very delicate  
 200 mm, 8"



DE BAKEY Zahnung



Toothing DE BAKEY

**APRAUMATA®**

## Herz- und Gefäß-Chirurgie – Cardiovascular Surgery

Gewebe- und Organfasszangen

Tissue- and Organ Grasping Forceps

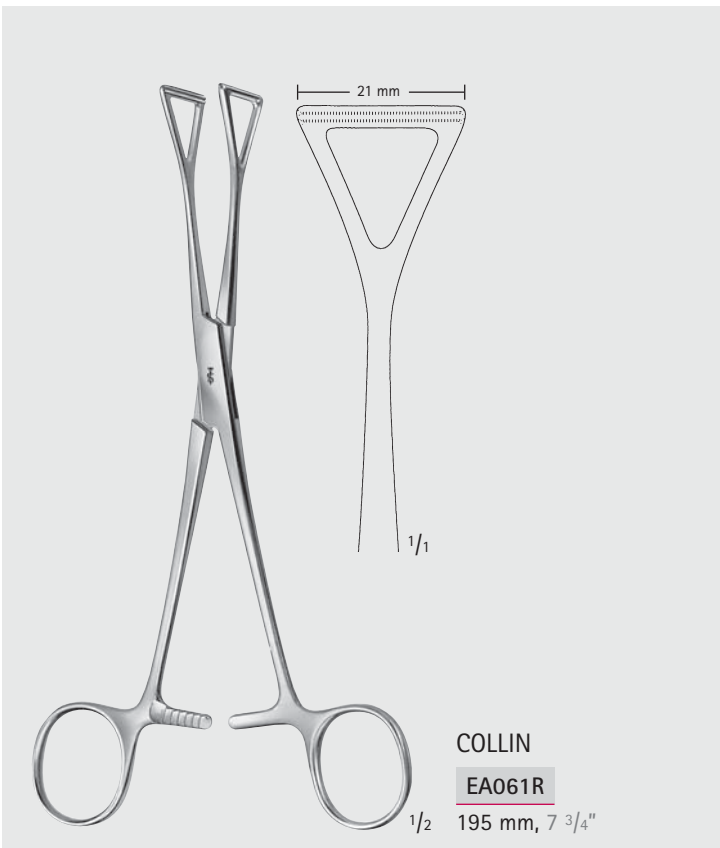
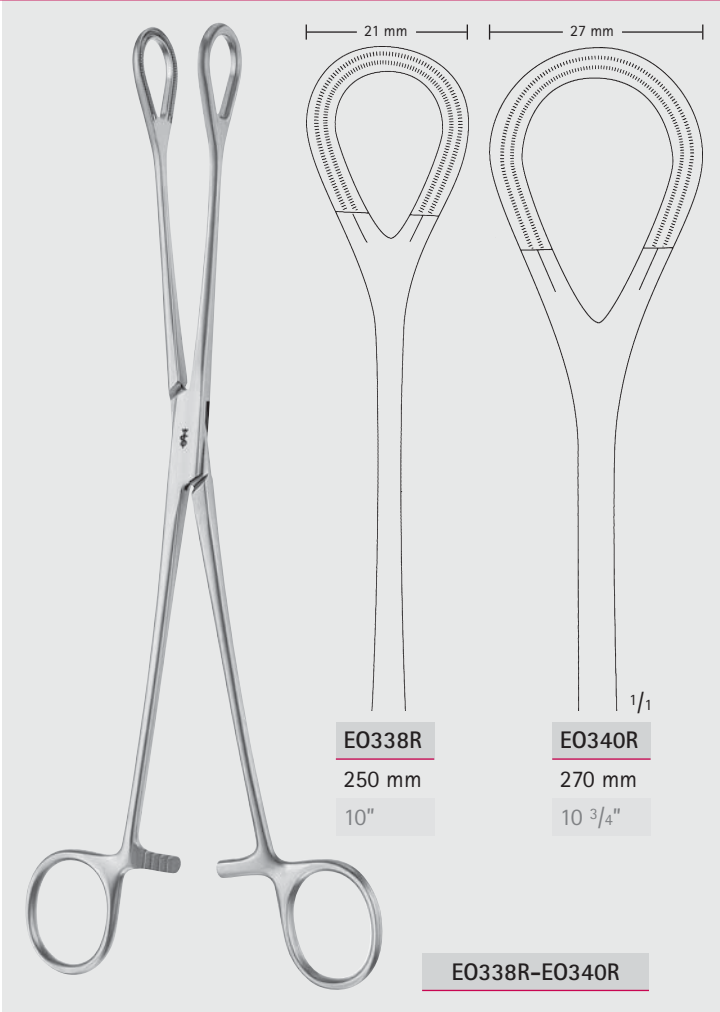

**FB**

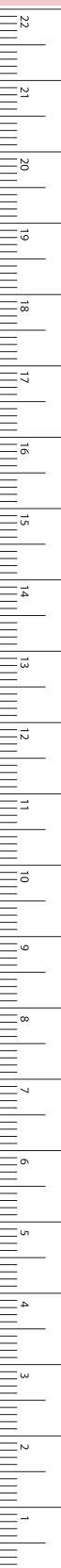

MILLIMETERS

## Herz- und Gefäß-Chirurgie – Cardiovascular Surgery

Fixierklemme, Carotis Shunt Klemmen

Fixation Clamp, Carotid Shunt Clamps

FB



BORST

**FB940R**

Klemme für eine effiziente Verklebung von Gewebeschichten bei der Aortendissektion  
Forceps for efficient tissue gluing in aortic dissection

215 mm, 8 1/2"



**MB238R**

168 mm

6 5/8"

**MB239R**

180 mm

7"

JAVID

**MB238R-MB239R**

Carotis Shunt Klemmen

Carotid shunt clamps

# Cardiovascular

## Vascular Clamps

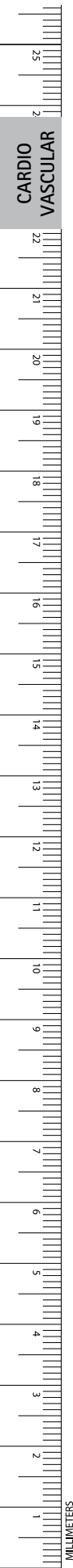

CARDIO  
VASCULAR

### WYLIE Hypogastric Clamp

Catalog Number	Jaw	Jaw Length (mm)	Shaft	Length (in.)
MB241	CVD	70	ANG	8 1/2
MB240	CVD	75	ANG	9 3/4



MB240-MB241

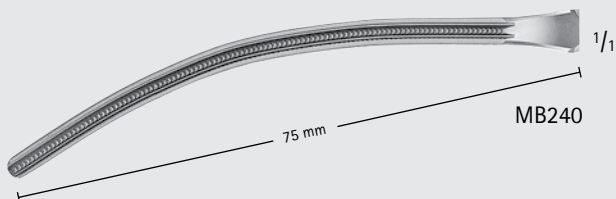
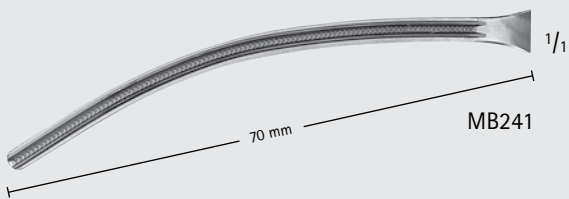

# Cardiovascular

## Vascular Clamps

### GREGORY Atraumata Profunda Clamp

Catalog Number	Jaw	Jaw Length (mm)	Length (in.)
MG014R	X-SMALL	29	5
MB750R	SMALL	57	5 3/4
MB751R	MEDIUM	62	7
MB752R	LARGE	75	7 3/4

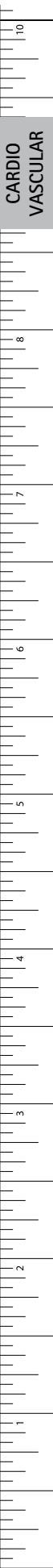
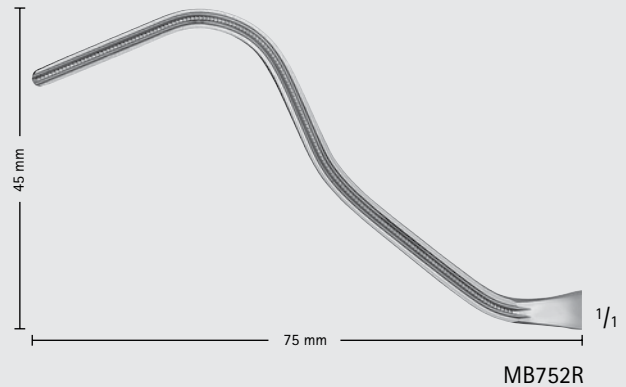
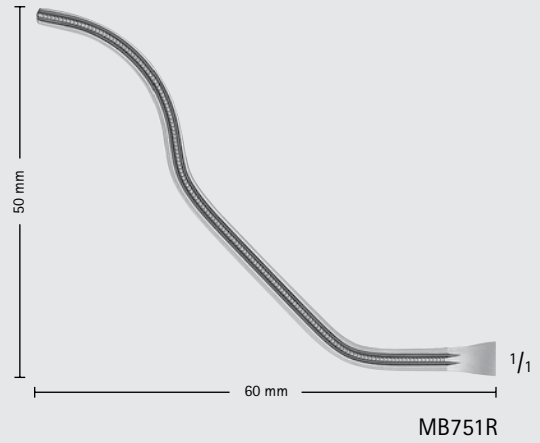
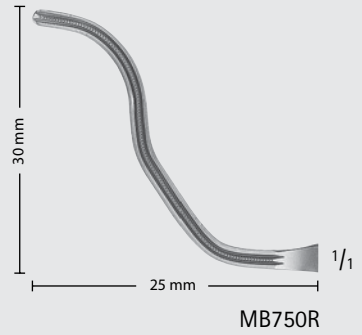
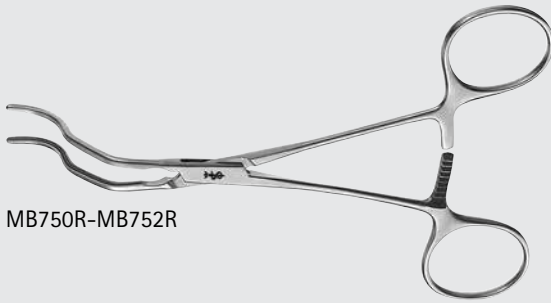
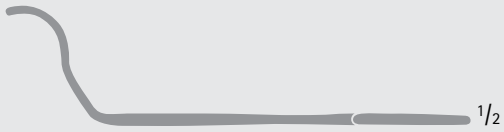
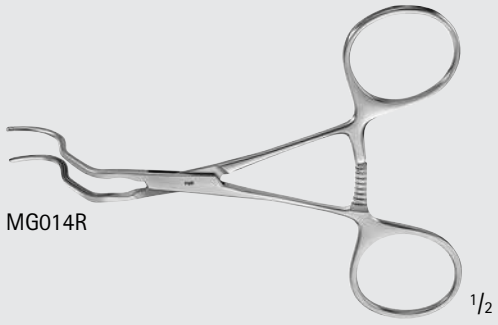

# Cardiovascular

## Forceps



FB397R-FB399R



FB397R



FB398R



FB399R

### RESANO Cardiac Valve Forceps

Catalog Number	Tip Size (mm)	Length (in.)
FB397R	2	7
FB398R	2	9
FB399R	2	11 3/4

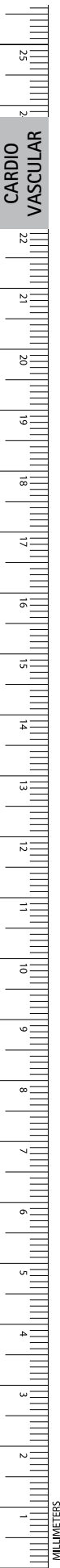

CARDIO  
VASCULAR

MILLIMETERS

# General Surgery

## Dressing and Tissue Forceps



FB401R-FB410R

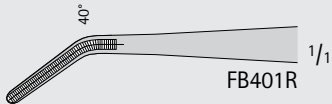

FB401R

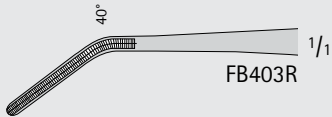

FB403R

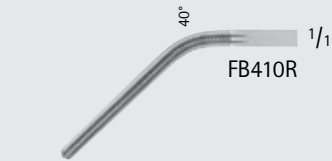

FB410R

DEBAKEY Atraumatic Forceps, Angled

Catalog Number	Tip Size (mm)	Length (in.)
FB401R	2	6
FB403R	2	7 7/8
FB410R	2	9 1/2

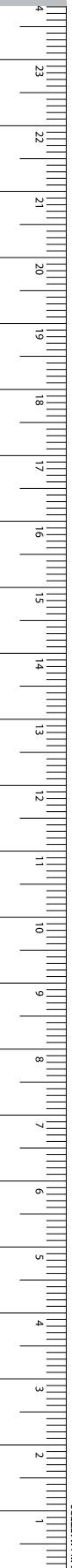

**По вопросам продаж и поддержки обращайтесь:**

Алматы (7273)495-231	Казань (843)206-01-48	Новокузнецк (3843)20-46-81	Смоленск (4812)29-41-54
Архангельск (8182)63-90-72	Калининград (4012)72-03-81	Новосибирск (383)227-86-73	Сочи (862)225-72-31
Астрахань (8512)99-46-04	Калуга (4842)92-23-67	Омск (3812)21-46-40	Ставрополь (8652)20-65-13
Барнаул (3852)73-04-60	Кемерово (3842)65-04-62	Орел (4862)44-53-42	Сургут (3462)77-98-35
Белгород (4722)40-23-64	Киров (8332)68-02-04	Оренбург (3532)37-68-04	Тверь (4822)63-31-35
Брянск (4832)59-03-52	Краснодар (861)203-40-90	Пенза (8412)22-31-16	Томск (3822)98-41-53
Владивосток (423)249-28-31	Красноярск (391)204-63-61	Пермь (342)205-81-47	Тула (4872)74-02-29
Волгоград (844)278-03-48	Курск (4712)77-13-04	Ростов-на-Дону (863)308-18-15	Тюмень (3452)66-21-18
Вологда (8172)26-41-59	Липецк (4742)52-20-81	Рязань (4912)46-61-64	Ульяновск (8422)24-23-59
Воронеж (473)204-51-73	Магнитогорск (3519)55-03-13	Самара (846)206-03-16	Уфа (347)229-48-12
Екатеринбург (343)384-55-89	Москва (495)268-04-70	Санкт-Петербург (812)309-46-40	Хабаровск (4212)92-98-04
Иваново (4932)77-34-06	Мурманск (8152)59-64-93	Саратов (845)249-38-78	Челябинск (351)202-03-61
Ижевск (3412)26-03-58	Набережные Челны (8552)20-53-41	Севастополь (8692)22-31-93	Череповец (8202)49-02-64
Иркутск (395)279-98-46	Нижний Новгород (831)429-08-12	Симферополь (3652)67-13-56	Ярославль (4852)69-52-93
Россия (495)268-04-70	Киргизия (996)312-96-26-47	Казахстан (7172)727-132	